



2025 CATALOGUE

cata 
green innovation



The technical characteristics indicated in the catalogue must be verified by the **THE MANUFACTURER**.

Non-contractual photographs.

Cata Electrodomésticos S.L.U. reserves the right to modify the characteristics of its products without prior notice.

© Design, layout, images and content are the property of **Cata Electrodomésticos S.L.U.**



CATALOGUE2025

CATA, the company	p2-3
HOODS	p4-31
RENOVA PUR AIR	p4
SURFACE INTEGRATION	p4-5
DECORATIVE ISLANDS	p5-7
CORNER	p7-8
DECORATIVE HOODS	p8-25
BUILT-IN HOODS	p26-30
INSERTS	p30-33
TELESCOPIC	p34-38
CONVENTIONAL	p39-40
KITCHEN EXTRACTORS	p41
OVENS	p42-47
MICROWAVES	p47-49
HOBS	p50-61
INDUCTION	p50-55
VITROCERAMIC	p55-56
GAS	p57-61
KITCHENWARE	p62
WHITE GOODS	p62-63
WINE COOLERS	p63-65
SINKS and TAPS	p66-73
TECHNICAL INFORMATION	p74-124





Spanish Company

CATA ELECTRODOMÉSTICOS, S.L.U., manufacturer of household appliances, founded in Torelló, Spain, in 1947. Since then, we have been pioneers in the domestic extraction business. Our wide product range includes extractors, hoods, hobs, ovens, microwaves, taps, sinks, dishwashers, washing machines, refrigerators, wine coolers and kitchenware.

Our values: Commitment to our customers

The design and development of our products are based on painstaking studies with a clear orientation towards meeting our customers' needs, providing solutions to promote functionality, efficiency, durability and reliability while remaining environmentally friendly. Every detail is important. That is why, in our brand with more than seven decades of history, we have placed, and continue placing, special emphasis on all of them until we obtain the best possible product.





Experience

At **CATA** we are constantly researching. We use top-quality components together with the latest manufacturing techniques to achieve the most technologically advanced products on the market. Our proven experience in the creation, development and manufacturing processes are the pillars on which the high efficiency, quality and reliability of our products is based.

Energy efficiency Environment

At **CATA** we are committed to the environment and we think that your kitchen can be an example of energy efficiency. We strive; it is an obligation and a goal to be able to offer products that contribute to create a much more sustainable, clean and welcoming world.

Our low-energy household appliances will collaborate on energy savings, protecting the environment and noticing the economic savings of the use of efficient devices.



DECORATIVE HOOD



RENOVA PURE AIR VNV90

XGBK

Cod.: 02159420 EAN: 8422248343077



- ▶ **Recirculation hood with integrated air purifier.** Eliminates odors with an efficiency of 98% and purifies 100% of dust, bacteria, viruses and volatile organic compounds.
- ▶ 6 extraction levels, 5 + 1 **TURBO**
- ▶ Maintenance-free self-regeneratable carbon filter
- ▶ **Air purification function**
- ▶ **AUTO 2 connectivity for control of the CATA AUTO 2 hobs**
- ▶ BRUSHLESS motor.
- ▶ Motor maximum airflow free outlet: 1400m³/h
- ▶ Sound power: **46dB(A)**, maximum: 64dB(A)

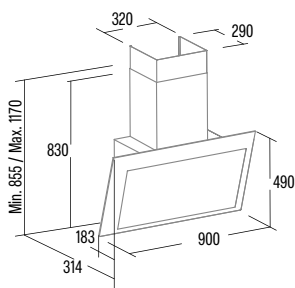

INTEGRATION

RENOVA PURE AIR MNV90

GWH

Cod.: 02189020 EAN: 8422248344692



- ▶ **Recirculation hood with integrated air purifier.** Eliminates odors with an efficiency of 98% and purifies 100% of dust, bacteria, viruses and volatile organic compounds.
- ▶ 6 extraction levels, 5 + 1 **TURBO**
- ▶ Maintenance-free self-regeneratable carbon filter
- ▶ **Air purification function**
- ▶ **AUTO 2 connectivity for control of the CATA AUTO 2 hobs**
- ▶ BRUSHLESS motor.
- ▶ Motor maximum airflow free outlet: 1400m³/h
- ▶ Sound power: **46dB(A)**, maximum: 64dB(A)

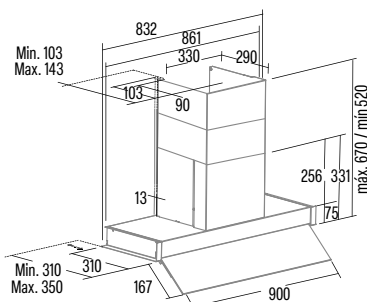

SURFACE INTEGRATION

IAS 7024

Cod.: 08000200 EAN: 8422248358699

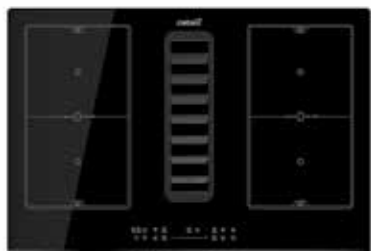

NEW

- ▶ **Slider Control Panel** with timer and cleaning filters indicator
- ▶ 6 extraction levels, 5 + 1 **TURBO**
- ▶ Extraction power: **691,5m³/h** - 325,6m³/h
- ▶ Motor maximum airflow free outlet: 825m³/h
- ▶ Sound power: **50dB(A)**, maximum: 68dB(A)
- ▶ Airflow speed: 10 m/s
- ▶ BRUSHLESS motor. Ultra silent. Maximum energy consumption **165W**
- ▶ **Installation height 17cm**
- ▶ **Energy Class: A+**

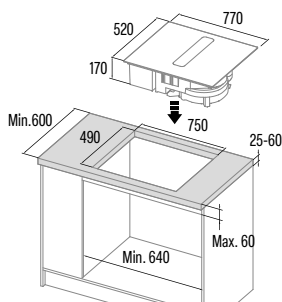

AS 750

Cod.: 08000405 EAN: 8422248109406

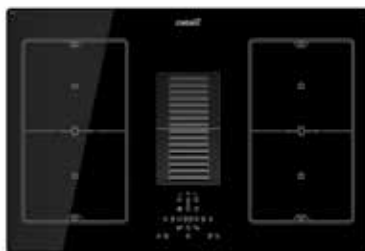

- ▶ **Touch Control Panel** with timer and cleaning filters indicator
- ▶ 6 extraction levels, 5 + 1 **TURBO** and **AUTO** function
- ▶ Extraction power: **580m³/h** - 200m³/h
- ▶ Motor maximum airflow free outlet: 950m³/h
- ▶ Sound power: **45dB(A)**, maximum: 64dB(A)
- ▶ BRUSHLESS motor. Ultra silent. Maximum energy consumption **135W**
- ▶ **Energy Class: A**

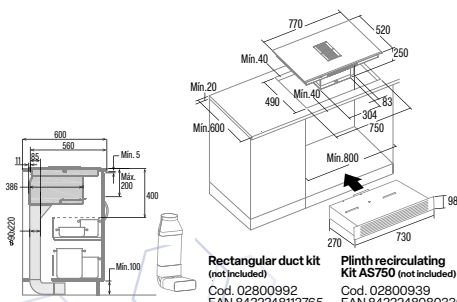

IAS 6024

Cod.: 08000206 EAN: 8422248358705

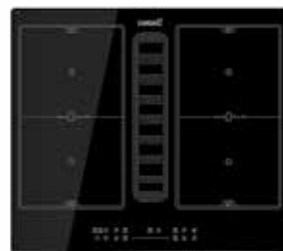

NEW

- ▶ **Slider Control Panel** with timer and cleaning filters indicator
- ▶ 6 extraction levels, 5 + 1 **TURBO**
- ▶ Extraction power: **673,2m³/h** - 325m³/h
- ▶ Motor maximum airflow free outlet: 805m³/h
- ▶ Sound power: **50dB(A)**, maximum: 68dB(A)
- ▶ Airflow speed: 10 m/s
- ▶ BRUSHLESS motor. Ultra silent. Maximum energy consumption **165W**
- ▶ **Installation height 17cm**
- ▶ **Energy Class: A+**

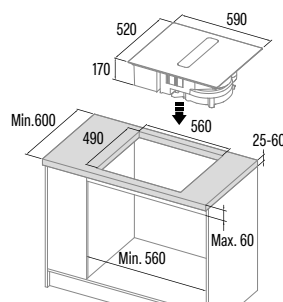

AS 600

Cod.: **08000406** EAN: **8422248198554**



- ▶ **Touch Control** Panel with timer and cleaning filters indicator
- ▶ 6 extraction levels, 5 + 1 **TURBO** and AUTO function
- ▶ Extraction power: **510m³/h** - 230m³/h
- ▶ Motor maximum airflow free outlet: 950m³/h
- ▶ Sound power: **62dB(A)**, maximum: 67dB(A)
- ▶ **BRUSHLESS** motor. Ultra silent. Maximum energy consumption **135W**
- ▶ **Energy Class: A+**

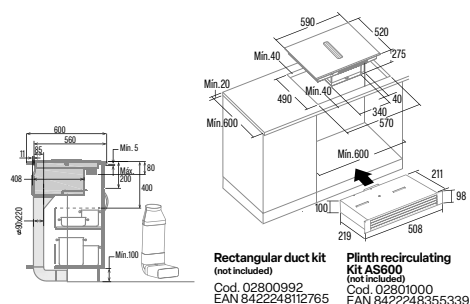

DECORATIVE ISLANDS

MAGRABA ISLAND

Cod.: **02119207** EAN: **8422248069342**



- ▶ **Electronic control panel** with automatic shut-down timer
- ▶ 3 extraction levels
- ▶ Extraction power: **645m³/h** - 300m³/h
- ▶ Motor maximum airflow free outlet: 1200m³/h
- ▶ Sound power: **48dB(A)**, maximum: 63dB(A)
- ▶ BT2 motor. Extra silent.
- Maximum energy consumption **200W**
- ▶ High efficiency LED lighting
- ▶ Energy class: C

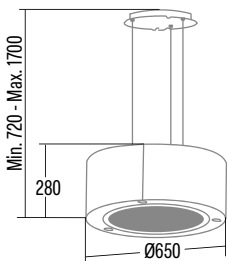

MOON ISLAND

Cod.: **02119203** EAN: **8422248062084**



- ▶ **Touch control panel** with automatic shut-down timer and cleaning filters indicator
- ▶ 3 extraction levels
- ▶ Extraction power: **645m³/h** - 300m³/h
- ▶ Motor maximum airflow free outlet: 1200m³/h
- ▶ Sound power: **48dB(A)**, maximum: 63dB(A)
- ▶ BT2 motor. Extra silent.
- Maximum energy consumption **200W**
- ▶ High efficiency LED lighting, adjustable intensity
- ▶ Energy Class: C

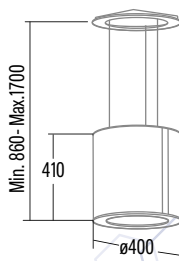

FARO X ISLAND

Cod.: **02119101** EAN: **8422248074230**



- ▶ **Electronic control panel** with automatic shut-down timer
- ▶ 3 extraction levels, 2 + 1 **TURBO**
- ▶ Extraction power: **800m³/h** - 340m³/h
- ▶ Motor maximum airflow free outlet: 1350m³/h
- ▶ Sound power: **50dB(A)**, maximum: 65dB(A)
- ▶ BT3 motor. Extra silent.
- Maximum energy consumption **280W**
- ▶ High efficiency LED lighting
- ▶ **Energy class: A**

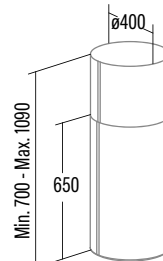

DECORATIVE ISLANDS

FARO BK ISLAND

Cod.: 02119401 EAN: 8422248370837



NEW

- ▶ **Electronic control panel** with automatic shut-down timer
- ▶ 4 extraction levels, 3 + **1 TURBO**
- ▶ Extraction power: **706m³/h** - 334m³/h
- ▶ Motor maximum airflow free outlet: 1350m³/h
- ▶ Sound power: **50dB(A)**, maximum: 69dB(A)
- ▶ BT5AC motor. Extra silent.
- ▶ Maximum energy consumption **280W**
- ▶ High efficiency Compact STRIP LED lighting, adjustable intensity
- ▶ Energy class: B

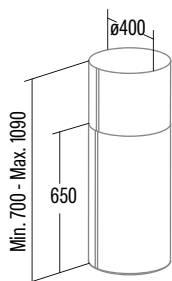

BENNU SLIM 1200 X ISLAND

Cod.: 02111309 EAN: 8422248112642

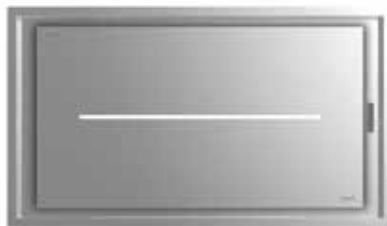

- ▶ **Touch control panel** with automatic shut-down timer and cleaning filters indicator + remote control
- ▶ 6 extraction levels, 5 + **1 TURBO**
- ▶ Extraction power: **570m³/h** - 266m³/h
- ▶ Motor maximum airflow free outlet: 1200m³/h
- ▶ Sound power: **50dB(A)**, maximum: 65dB(A)
- ▶ Motor S6. Extra silent. Maximum energy consumption **90W**
- ▶ **AUTO 2 connectivity for control of the CATA AUTO 2 hobs**
- ▶ **High-efficiency lighting by intensity-adjustable two-tone warm / natural LED STRIP**
- ▶ **Energy class: A+**

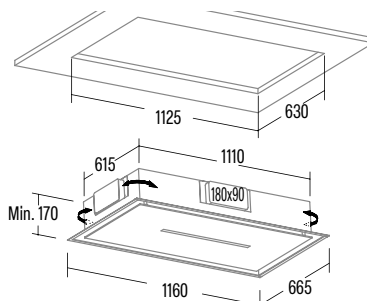

BENNU SLIM 900 X ISLAND

Cod.: 02111308 EAN: 8422248110891

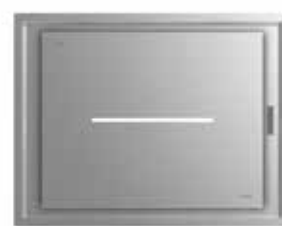

- ▶ **Touch control panel** with automatic shut-down timer and cleaning filters indicator + remote control
- ▶ 6 extraction levels, 5 + **1 TURBO**
- ▶ Extraction power: **570m³/h** - 266m³/h
- ▶ Motor maximum airflow free outlet: 1200m³/h
- ▶ Sound power: **50dB(A)**, maximum: 65dB(A)
- ▶ Motor S6. Extra silent. Maximum energy consumption **90W**
- ▶ **AUTO 2 connectivity for control of the CATA AUTO 2 hobs**
- ▶ **High-efficiency lighting by intensity-adjustable two-tone warm / natural LED STRIP**
- ▶ **Energy class: A+**

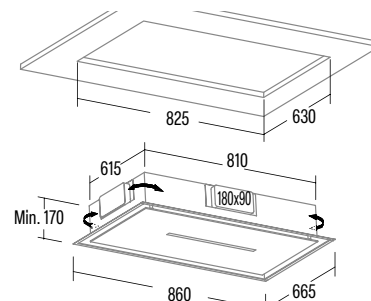

SIRIN 1000 GWH ISLAND

Cod.: 02111002 EAN: 8422248097437



- ▶ **Touch control panel** with automatic shut-down timer and cleaning filters indicator + remote control
- ▶ Central glass panel
- ▶ 4 extraction levels, 3 + **1 TURBO**
- ▶ Extraction power: **850m³/h** - 340m³/h
- ▶ Motor maximum airflow free outlet: 1350m³/h
- ▶ Sound power: **50dB(A)**, maximum: 65dB(A)
- ▶ BT3 motor. Extra silent.
- ▶ Maximum energy consumption **280W**
- ▶ High efficiency LED lighting, adjustable intensity
- ▶ **Energy class: A**

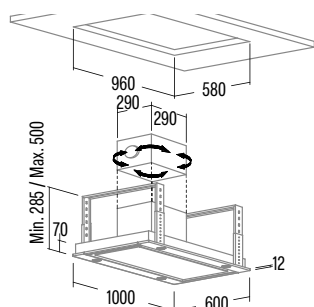

SIRIN 1000 WH ISLAND

Cod.: 02111001 EAN: 8422248077750

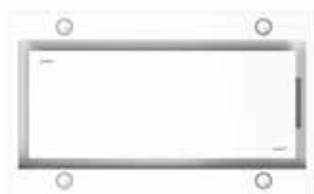

- ▶ **Touch control panel** with automatic shut-down timer and cleaning filters indicator + remote control
- ▶ 4 extraction levels, 3 + **1 TURBO**
- ▶ Extraction power: **850m³/h** - 340m³/h
- ▶ Motor maximum airflow free outlet: 1350m³/h
- ▶ Sound power: **50dB(A)**, maximum: 65dB(A)
- ▶ BT3 motor. Extra silent.
- ▶ Maximum energy consumption **280W**
- ▶ High efficiency LED lighting, adjustable intensity
- ▶ **Energy Class: A**

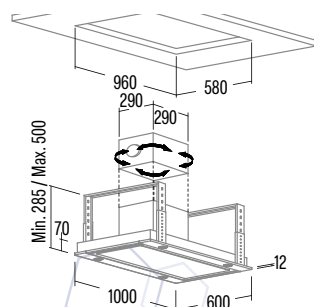

FENIX 1000 X ISLAND

Cod.: 02111305 EAN: 8422248077798



- ▶ **Touch control panel** with automatic shut-down timer and cleaning filters indicator + remote control
- ▶ 4 extraction levels, 3 + **1 TURBO**
- ▶ Extraction power: **850m³/h** - 340m³/h
- ▶ Motor maximum airflow free outlet: 1350m³/h
- ▶ Sound power: **50dB(A)**, maximum: 65dB(A)
- ▶ BT3 motor. Extra silent.
- ▶ Maximum energy consumption **280W**
- ▶ High efficiency LED lighting, adjustable intensity
- ▶ **Energy Class: A**

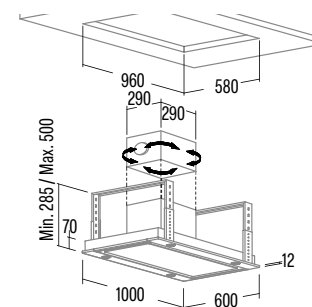

LEGEND 900 XGBK ISLAND

Cod.: 02097202 EAN: 8422248061681



- ▶ **Touch Control Panel** with timer and cleaning filters indicator
- ▶ 5 extraction levels, 4 + **1 TURBO**
- ▶ Extraction power: **820m³/h** - 200m³/h
- ▶ Motor maximum airflow free outlet: 1200m³/h
- ▶ Sound power: **40dB(A)**, maximum: 64dB(A)
- ▶ BRUSHLESS motor. Ultra silent.
- ▶ Maximum energy consumption **130W**
- ▶ High efficiency Led lighting, adjustable intensity
- ▶ **Energy Class: A+**

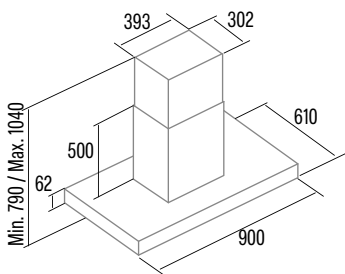

SYGMA 900 X ISLAND

Cod.: 02197313 EAN: 8422248062121



- ▶ **Electronic control Panel** with automatic shut down timer
- ▶ 3 extraction levels, 2 + **1 TURBO**
- ▶ Extraction power: **850m³/h** - 340m³/h
- ▶ Motor maximum airflow free outlet: 1350m³/h
- ▶ Sound power: **50dB(A)**, maximum: 65dB(A)
- ▶ BT3 motor. Extra silent.
- ▶ Maximum energy consumption **280W**
- ▶ High efficiency LED lighting
- ▶ **Energy Class: A**

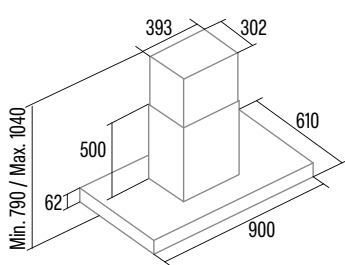

GAMMA 900 X ISLAND

Cod.: 02025205 EAN: 8422248077736



- ▶ **Electronic control Panel** with automatic shut down timer
- ▶ 3 extraction levels, 2 + **1 TURBO**
- ▶ Extraction power: **850m³/h** - 340m³/h
- ▶ Motor maximum airflow free outlet: 1350m³/h
- ▶ Sound power: **50dB(A)**, maximum: 65dB(A)
- ▶ BT3 motor. Extra silent.
- ▶ Maximum energy consumption **280W**
- ▶ High efficiency LED lighting
- ▶ **Energy Class: A**

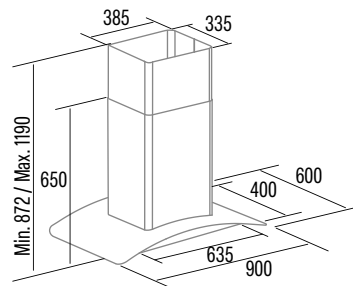

VEGA X ISLAND

Cod.: 02119311 EAN: 8422248077743



- ▶ **Electronic control Panel** with automatic shut down timer
- ▶ 3 extraction levels, 2 + **1 TURBO**
- ▶ Extraction power: **850m³/h** - 340m³/h
- ▶ Motor maximum airflow free outlet: 1350m³/h
- ▶ Sound power: **50dB(A)**, maximum: 65dB(A)
- ▶ BT3 motor. Extra silent.
- ▶ Maximum energy consumption **280W**
- ▶ High efficiency LED lighting
- ▶ **Energy Class: A**

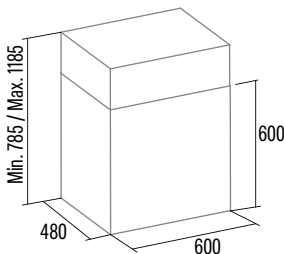

CORNER HOODS

GALA 900 L

Cod.: 02169304 EAN: 8422248355575



- ▶ **Electronic control Panel** with automatic shut down timer
- ▶ 4 extraction levels, 3 + **1 TURBO**
- ▶ Extraction power: **802m³/h** - 340m³/h
- ▶ Motor maximum airflow free outlet: 1350m³/h
- ▶ Sound power: **50dB(A)**, maximum: 65dB(A)
- ▶ BT3 motor. Extra silent.
- ▶ Maximum energy consumption **280W**
- ▶ **High-efficiency lighting by intensity-adjustable two-tone warm / natural LED STRIP**
- ▶ **Energy Class: A**

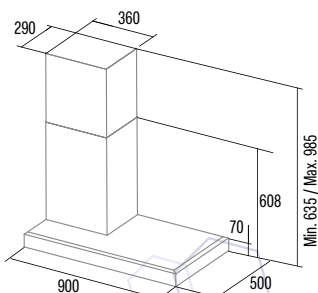

GALA 900 R

Cod.: 02166304 EAN: 8422248355582



- ▶ **Electronic control Panel** with automatic shut down timer
- ▶ 4 extraction levels, 3 + **1 TURBO**
- ▶ Extraction power: **802m³/h** - 340m³/h
- ▶ Motor maximum airflow free outlet: 1350m³/h
- ▶ Sound power: **50dB(A)**, maximum: 65dB(A)
- ▶ BT3 motor. Extra silent.
- ▶ Maximum energy consumption **280W**
- ▶ **High-efficiency lighting by intensity-adjustable two-tone warm / natural LED STRIP**
- ▶ **Energy Class: A**

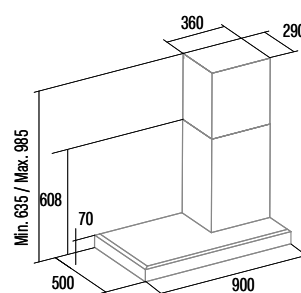

CORNER HOODS

ANGOLO BOX 1000 X

Cod.: 02195309 EAN: 8422248077774



- ▶ **Electronic control Panel** with automatic shut down timer
- ▶ 3 extraction levels, 2 + **1 TURBO**
- ▶ Extraction power: **850m³/h** - 340m³/h
- ▶ Motor maximum airflow free outlet: 1350m³/h
- ▶ Sound power: **50dB(A)**, maximum: 65dB(A)
- ▶ BT3 motor. Extra silent.
- ▶ Maximum energy consumption **280W**
- ▶ High efficiency strip LED lighting
- ▶ **Energy Class: A**

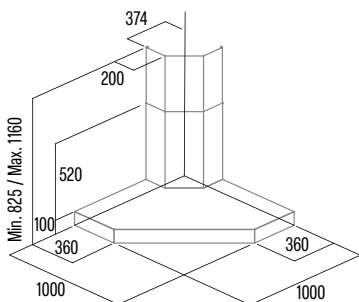

cata & Can Rocca

ANGOLO X

Cod.: 02195310 EAN: 8422248077781



- ▶ **Electronic control Panel** with automatic shut down timer
- ▶ 3 extraction levels, 2 + **1 TURBO**
- ▶ Extraction power: **850m³/h** - 340m³/h
- ▶ Motor maximum airflow free outlet: 1350m³/h
- ▶ Sound power: **52dB(A)**, maximum: 67dB(A)
- ▶ BT3 motor. Extra silent.
- ▶ Maximum energy consumption **280W**
- ▶ High efficiency strip LED lighting
- ▶ **Energy Class: A**

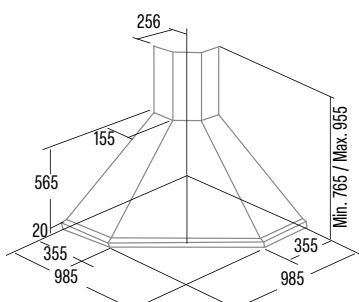

DECORATIVE HOODS

cata & Can Rocca

THALASSA EVO NO DRIP 900 GBK

Cod.: 02139409 EAN: 8422248356473



- ▶ **Touch Control Panel** with digital display, automatic shut-down timer and cleaning filters indicator
- ▶ 6 extraction levels, 5 + **1 TURBO**
- ▶ Extraction power : **1.007m³/h** - 205m³/h
- ▶ Sound power: **45dB(A)**, maximum: 67dB(A)
- ▶ BT5 DC BRUSHLESS motor. Ultra silent. Maximum energy consumption **250W**
- ▶ **High-efficiency lighting by intensity-adjustable two-tone warm / natural LED STRIP**
- ▶ **AUTO 2 connectivity with automatic control from the CATA AUTO 2 hob**
- ▶ Fresh function. Pneumatic opening
- ▶ **Anti-condensation system on glass**
- ▶ **Energy Class: A+**

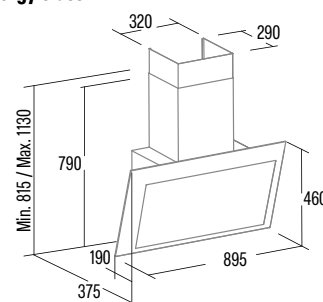

THALASSA EVO NO DRIP 700 GBK

Cod.: 02137409 EAN: 8422248356480



- ▶ **Touch Control Panel** with digital display, automatic shut-down timer and cleaning filters indicator
- ▶ 6 extraction levels, 5 + **1 TURBO**
- ▶ Extraction power : **1.007m³/h** - 205m³/h
- ▶ Sound power: **45dB(A)**, maximum: 67dB(A)
- ▶ BT5 DC BRUSHLESS motor. Ultra silent. Maximum energy consumption **250W**
- ▶ **High-efficiency lighting by intensity-adjustable two-tone warm / natural LED STRIP**
- ▶ **AUTO 2 connectivity with automatic control from the CATA AUTO 2 hob**
- ▶ Fresh function. Pneumatic opening
- ▶ **Anti-condensation system on glass**
- ▶ **Energy Class: A+**

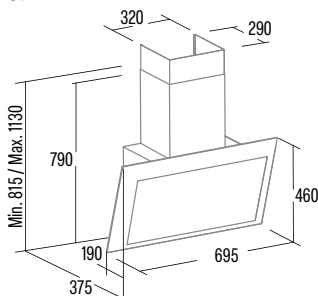

THALASSA EVO 900 GBK

Cod.: 02139408 EAN: 8422248356398



- ▶ **Touch Control Panel** with digital display, automatic shut-down timer and cleaning filters indicator
- ▶ 6 extraction levels, 5 + **1 TURBO**
- ▶ Extraction power : **1.007m³/h** - 205m³/h
- ▶ Sound power: **45dB(A)**, maximum: 67dB(A)
- ▶ BT5 DC BRUSHLESS motor. Ultra silent. Maximum energy consumption **250W**
- ▶ **High-efficiency lighting by intensity-adjustable two-tone warm / natural LED STRIP**
- ▶ **AUTO 2 connectivity with automatic control from the CATA AUTO 2 hob**
- ▶ Fresh function. Pneumatic opening
- ▶ **Energy Class: A+**

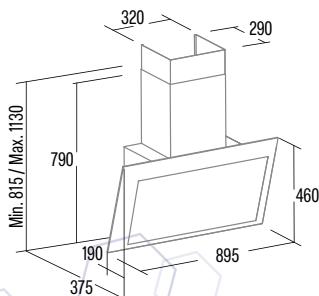

THALASSA EVO 800 GBK

Cod.: 02138408 EAN: 8422248356404



- ▶ **Touch Control Panel** with digital display, automatic shut-down timer and cleaning filters indicator
- ▶ 6 extraction levels, 5 + **1 TURBO**
- ▶ Extraction power : **1.007m³/h** - 205m³/h
- ▶ Sound power: **45dB(A)**, maximum: 67dB(A)
- ▶ BT5 DC BRUSHLESS motor. Ultra silent. Maximum energy consumption **250W**
- ▶ **High-efficiency lighting by intensity-adjustable two-tone warm / natural LED STRIP**
- ▶ **AUTO 2 connectivity with automatic control from the CATA AUTO 2 hob**
- ▶ Fresh function. Pneumatic opening
- ▶ **Energy Class: A+**

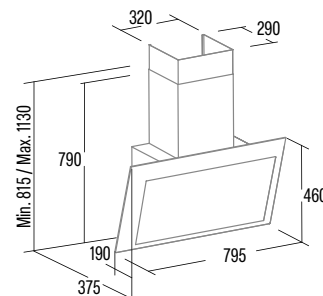

THALASSA EVO 700 GBK

Cod.: 02137408 EAN: 8422248356411



- ▶ **Touch Control Panel** with digital display, automatic shut-down timer and cleaning filters indicator
- ▶ 6 extraction levels, 5 + **1 TURBO**
- ▶ Extraction power : **1.007m³/h** - 205m³/h
- ▶ Sound power: **45dB(A)**, maximum: 67dB(A)
- ▶ BT5 DC BRUSHLESS motor. Ultra silent. Maximum energy consumption **250W**
- ▶ **High-efficiency lighting by intensity-adjustable two-tone warm / natural LED STRIP**
- ▶ **AUTO 2 connectivity with automatic control from the CATA AUTO 2 hob**
- ▶ Fresh function. Pneumatic opening
- ▶ **Energy Class: A+**

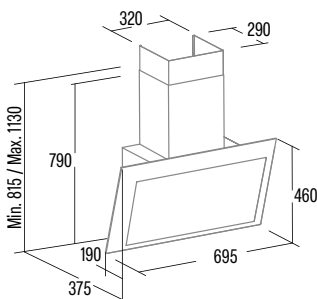

THALASSA EVO 600 GBK

Cod.: 02136408 EAN: 8422248356428



- ▶ **Touch Control Panel** with digital display, automatic shut-down timer and cleaning filters indicator
- ▶ 6 extraction levels, 5 + **1 TURBO**
- ▶ Extraction power : **1.007m³/h** - 205m³/h
- ▶ Sound power: **45dB(A)**, maximum: 67dB(A)
- ▶ BT5 DC BRUSHLESS motor. Ultra silent. Maximum energy consumption **250W**
- ▶ **High-efficiency lighting by intensity-adjustable two-tone warm / natural LED STRIP**
- ▶ **AUTO 2 connectivity with automatic control from the CATA AUTO 2 hob**
- ▶ Fresh function. Pneumatic opening
- ▶ **Energy Class: A+**

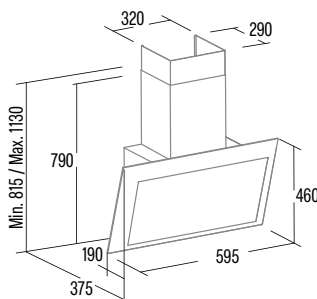

THALASSA EVO 900 GWH

Cod.: 02139008 EAN: 8422248356435



- ▶ **Touch Control Panel** with digital display, automatic shut-down timer and cleaning filters indicator
- ▶ 6 extraction levels, 5 + **1 TURBO**
- ▶ Extraction power : **1.007m³/h** - 205m³/h
- ▶ Sound power: **45dB(A)**, maximum: 67dB(A)
- ▶ BT5 DC BRUSHLESS motor. Ultra silent. Maximum energy consumption **250W**
- ▶ **High-efficiency lighting by intensity-adjustable two-tone warm / natural LED STRIP**
- ▶ **AUTO 2 connectivity with automatic control from the CATA AUTO 2 hob**
- ▶ Fresh function. Pneumatic opening
- ▶ **Energy Class: A+**

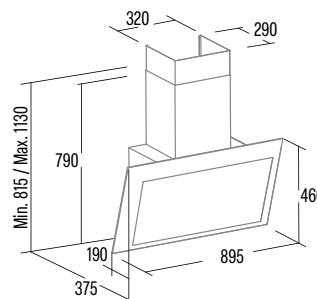

THALASSA EVO 800 GWH

Cod.: 02138008 EAN: 8422248356442



- ▶ **Touch Control Panel** with digital display, automatic shut-down timer and cleaning filters indicator
- ▶ 6 extraction levels, 5 + **1 TURBO**
- ▶ Extraction power : **1.007m³/h** - 205m³/h
- ▶ Sound power: **45dB(A)**, maximum: 67dB(A)
- ▶ BT5 DC BRUSHLESS motor. Ultra silent. Maximum energy consumption **250W**
- ▶ **High-efficiency lighting by intensity-adjustable two-tone warm / natural LED STRIP**
- ▶ **AUTO 2 connectivity with automatic control from the CATA AUTO 2 hob**
- ▶ Fresh function. Pneumatic opening
- ▶ **Energy Class: A+**

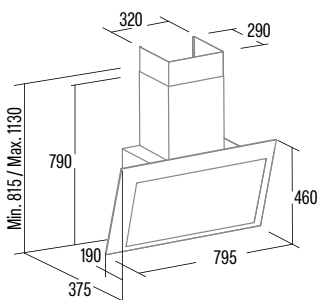

THALASSA EVO 700 GWH

Cod.: 02137008 EAN: 8422248356459



- ▶ **Touch Control Panel** with digital display, automatic shut-down timer and cleaning filters indicator
- ▶ 6 extraction levels, 5 + **1 TURBO**
- ▶ Extraction power : **1.007m³/h** - 205m³/h
- ▶ Sound power: **45dB(A)**, maximum: 67dB(A)
- ▶ BT5 DC BRUSHLESS motor. Ultra silent. Maximum energy consumption **250W**
- ▶ **High-efficiency lighting by intensity-adjustable two-tone warm / natural LED STRIP**
- ▶ **AUTO 2 connectivity with automatic control from the CATA AUTO 2 hob**
- ▶ Fresh function. Pneumatic opening
- ▶ **Energy Class: A+**

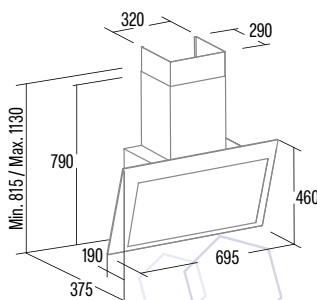

THALASSA EVO 600 GWH

Cod.: 02136008 EAN: 8422248356466



- ▶ **Touch Control Panel** with digital display, automatic shut-down timer and cleaning filters indicator
- ▶ 6 extraction levels, 5 + **1 TURBO**
- ▶ Extraction power : **1.007m³/h** - 205m³/h
- ▶ Sound power: **45dB(A)**, maximum: 67dB(A)
- ▶ BT5 DC BRUSHLESS motor. Ultra silent. Maximum energy consumption **250W**
- ▶ **High-efficiency lighting by intensity-adjustable two-tone warm / natural LED STRIP**
- ▶ **AUTO 2 connectivity with automatic control from the CATA AUTO 2 hob**
- ▶ Fresh function. Pneumatic opening
- ▶ **Energy Class: A+**

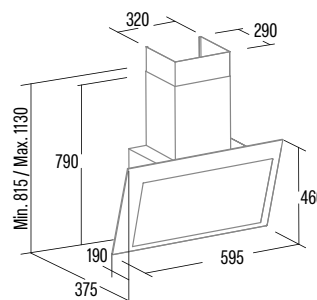

DECORATIVE HOODS

THALASSA PRO 1200 GBK

Cod.: 02131407 EAN: 8422248356329



- ▶ **Touch Control Panel** with digital display, automatic shut-down timer and cleaning filters indicator
- ▶ 6 extraction levels, 5 + 1 **TURBO**
- ▶ Extraction power: **842m³/h** -283m³/h
- ▶ Motor maximum airflow free outlet: 1400m³/h
- ▶ Sound power: **46dB(A)**, maximum: 64dB(A)
- ▶ BRUSHLESS motor. Ultra silent. Maximum energy consumption **135W**
- ▶ **AUTO 2 connectivity for control of the CATA AUTO 2 hobs**
- ▶ **High-efficiency lighting by intensity-adjustable two-tone warm / natural LED STRIP**
- ▶ Air purification function. Pneumatic opening
- ▶ **Energy Class: A+++**

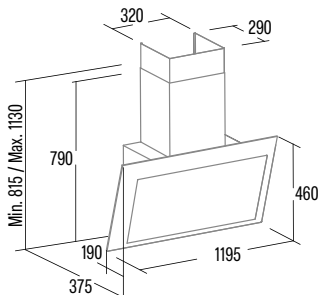

THALASSA PRO 900 GBK

Cod.: 02139407 EAN: 8422248356282



- ▶ **Touch Control Panel** with digital display, automatic shut-down timer and cleaning filters indicator
- ▶ 6 extraction levels, 5 + 1 **TURBO**
- ▶ Extraction power: **842m³/h** -283m³/h
- ▶ Motor maximum airflow free outlet: 1400m³/h
- ▶ Sound power: **46dB(A)**, maximum: 64dB(A)
- ▶ BRUSHLESS motor. Ultra silent. Maximum energy consumption **135W**
- ▶ **AUTO 2 connectivity for control of the CATA AUTO 2 hobs**
- ▶ **High-efficiency lighting by intensity-adjustable two-tone warm / natural LED STRIP**
- ▶ Air purification function. Pneumatic opening
- ▶ **Energy Class: A+++**

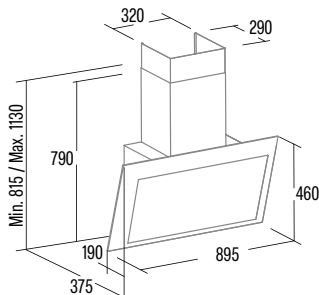

THALASSA PRO 800 GBK

Cod.: 02138407 EAN: 8422248356299



- ▶ **Touch Control Panel** with digital display, automatic shut-down timer and cleaning filters indicator
- ▶ 6 extraction levels, 5 + 1 **TURBO**
- ▶ Extraction power: **842m³/h** -283m³/h
- ▶ Motor maximum airflow free outlet: 1400m³/h
- ▶ Sound power: **46dB(A)**, maximum: 64dB(A)
- ▶ BRUSHLESS motor. Ultra silent. Maximum energy consumption **135W**
- ▶ **AUTO 2 connectivity for control of the CATA AUTO 2 hobs**
- ▶ **High-efficiency lighting by intensity-adjustable two-tone warm / natural LED STRIP**
- ▶ Air purification function. Pneumatic opening
- ▶ **Energy Class: A+++**

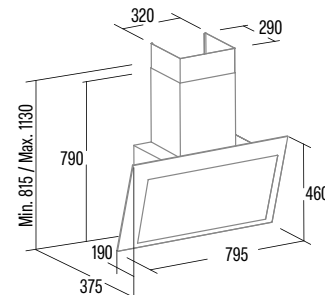

THALASSA PRO 700 GBK

Cod.: 02137407 EAN: 8422248356305



- ▶ **Touch Control Panel** with digital display, automatic shut-down timer and cleaning filters indicator
- ▶ 6 extraction levels, 5 + 1 **TURBO**
- ▶ Extraction power: **842m³/h** -283m³/h
- ▶ Motor maximum airflow free outlet: 1400m³/h
- ▶ Sound power: **46dB(A)**, maximum: 64dB(A)
- ▶ BRUSHLESS motor. Ultra silent. Maximum energy consumption **135W**
- ▶ **AUTO 2 connectivity for control of the CATA AUTO 2 hobs**
- ▶ **High-efficiency lighting by intensity-adjustable two-tone warm / natural LED STRIP**
- ▶ Air purification function. Pneumatic opening
- ▶ **Energy Class: A+++**

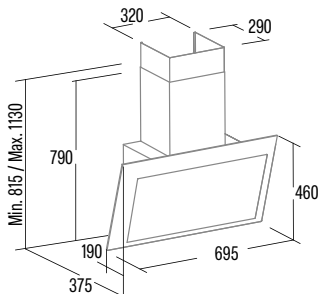

THALASSA PRO 600 GBK

Cod.: 02136407 EAN: 8422248356312



- ▶ **Touch Control Panel** with digital display, automatic shut-down timer and cleaning filters indicator
- ▶ 6 extraction levels, 5 + 1 **TURBO**
- ▶ Extraction power: **842m³/h** -283m³/h
- ▶ Motor maximum airflow free outlet: 1400m³/h
- ▶ Sound power: **46dB(A)**, maximum: 64dB(A)
- ▶ BRUSHLESS motor. Ultra silent. Maximum energy consumption **135W**
- ▶ **AUTO 2 connectivity for control of the CATA AUTO 2 hobs**
- ▶ **High-efficiency lighting by intensity-adjustable two-tone warm / natural LED STRIP**
- ▶ Air purification function. Pneumatic opening
- ▶ **Energy Class: A+++**

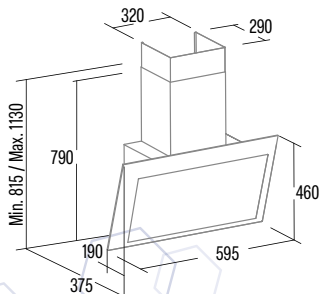

THALASSA PRO 900 GWH

Cod.: 02139007 EAN: 8422248356336



- ▶ **Touch Control Panel** with digital display, automatic shut-down timer and cleaning filters indicator
- ▶ 6 extraction levels, 5 + 1 **TURBO**
- ▶ Extraction power: **842m³/h** -283m³/h
- ▶ Motor maximum airflow free outlet: 1400m³/h
- ▶ Sound power: **46dB(A)**, maximum: 64dB(A)
- ▶ BRUSHLESS motor. Ultra silent. Maximum energy consumption **135W**
- ▶ **AUTO 2 connectivity for control of the CATA AUTO 2 hobs**
- ▶ **High-efficiency lighting by intensity-adjustable two-tone warm / natural LED STRIP**
- ▶ Air purification function. Pneumatic opening
- ▶ **Energy Class: A+++**

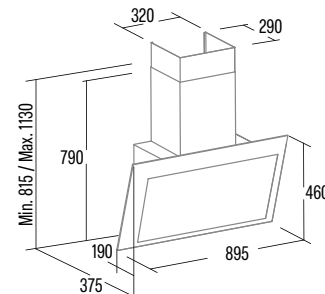

THALASSA PRO 800 GWH

Cod.: **02138007** EAN: **8422248356343**



- ▶ **Touch Control Panel** with digital display, automatic shut-down timer and cleaning filters indicator
- ▶ 6 extraction levels, 5 + **1 TURBO**
- ▶ Extraction power: **842m³/h** -283m³/h
- ▶ Motor maximum airflow free outlet: 1400m³/h
- ▶ Sound power: **46dB(A)**, maximum: 64dB(A)
- ▶ BRUSHLESS motor. Ultra silent. Maximum energy consumption **135W**
- ▶ **AUTO 2 connectivity for control of the CATA AUTO 2 hobs**
- ▶ **High-efficiency lighting by intensity-adjustable two-tone warm / natural LED STRIP**
- ▶ Air purification function. Pneumatic opening
- ▶ **Energy Class: A+++**

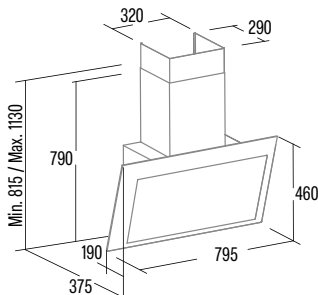

THALASSA PRO 700 GWH

Cod.: **02137007** EAN: **8422248356350**



- ▶ **Touch Control Panel** with digital display, automatic shut-down timer and cleaning filters indicator
- ▶ 6 extraction levels, 5 + **1 TURBO**
- ▶ Extraction power: **842m³/h** -283m³/h
- ▶ Motor maximum airflow free outlet: 1400m³/h
- ▶ Sound power: **46dB(A)**, maximum: 64dB(A)
- ▶ BRUSHLESS motor. Ultra silent. Maximum energy consumption **135W**
- ▶ **AUTO 2 connectivity for control of the CATA AUTO 2 hobs**
- ▶ **High-efficiency lighting by intensity-adjustable two-tone warm / natural LED STRIP**
- ▶ Air purification function. Pneumatic opening
- ▶ **Energy Class: A+++**

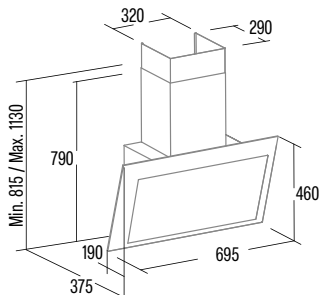

THALASSA PRO 600 GWH

Cod.: **02136007** EAN: **8422248356367**



- ▶ **Touch Control Panel** with digital display, automatic shut-down timer and cleaning filters indicator
- ▶ 6 extraction levels, 5 + **1 TURBO**
- ▶ Extraction power: **842m³/h** -283m³/h
- ▶ Motor maximum airflow free outlet: 1400m³/h
- ▶ Sound power: **46dB(A)**, maximum: 64dB(A)
- ▶ BRUSHLESS motor. Ultra silent. Maximum energy consumption **135W**
- ▶ **AUTO 2 connectivity for control of the CATA AUTO 2 hobs**
- ▶ **High-efficiency lighting by intensity-adjustable two-tone warm / natural LED STRIP**
- ▶ Air purification function. Pneumatic opening
- ▶ **Energy Class: A+++**

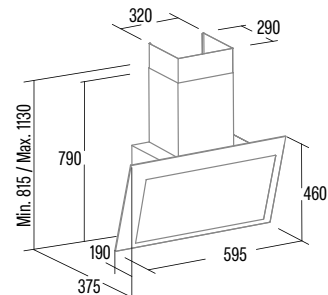

THALASSA PRO 900 GGR

Cod.: **02139507** EAN: **8422248356374**



- ▶ **Touch Control Panel** with digital display, automatic shut-down timer and cleaning filters indicator
- ▶ 6 extraction levels, 5 + **1 TURBO**
- ▶ Extraction power: **842m³/h** -283m³/h
- ▶ Motor maximum airflow free outlet: 1400m³/h
- ▶ Sound power: **46dB(A)**, maximum: 64dB(A)
- ▶ BRUSHLESS motor. Ultra silent. Maximum energy consumption **135W**
- ▶ **AUTO 2 connectivity for control of the CATA AUTO 2 hobs**
- ▶ **High-efficiency lighting by intensity-adjustable two-tone warm / natural LED STRIP**
- ▶ Air purification function. Pneumatic opening
- ▶ **Energy Class: A+++**

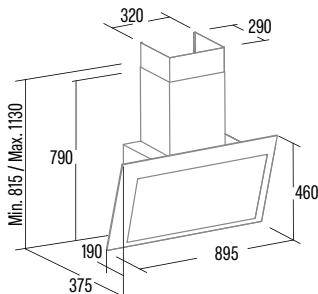

THALASSA PRO 800 GGR

Cod.: **02138507** EAN: **8422248356381**



- ▶ **Touch Control Panel** with digital display, automatic shut-down timer and cleaning filters indicator
- ▶ 6 extraction levels, 5 + **1 TURBO**
- ▶ Extraction power: **842m³/h** -283m³/h
- ▶ Motor maximum airflow free outlet: 1400m³/h
- ▶ Sound power: **46dB(A)**, maximum: 64dB(A)
- ▶ BRUSHLESS motor. Ultra silent. Maximum energy consumption **135W**
- ▶ **AUTO 2 connectivity for control of the CATA AUTO 2 hobs**
- ▶ **High-efficiency lighting by intensity-adjustable two-tone warm / natural LED STRIP**
- ▶ Air purification function. Pneumatic opening
- ▶ **Energy Class: A+++**

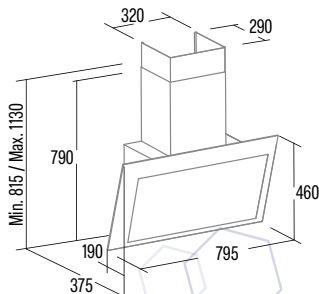

THALASSA 900 GBK

Cod.: **02139406** EAN: **8422248356220**



- ▶ **Electronic Control Panel** with digital display, automatic shut-down timer and cleaning filters indicator
- ▶ 6 extraction levels, 5 + **1 TURBO**
- ▶ Extraction power: **811m³/h** - 346m³/h
- ▶ Motor maximum airflow free outlet: 1200m³/h
- ▶ Sound power: **50dB(A)**, maximum: 65dB(A)
- ▶ BT3 motor. Extra silent. Maximum energy consumption **280W**
- ▶ **High-efficiency lighting by intensity-adjustable two-tone warm / natural LED STRIP**
- ▶ Air purification function. Pneumatic opening
- ▶ **Energy Class: A+**

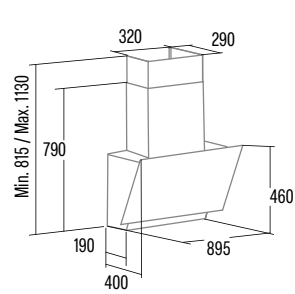

DECORATIVE HOODS

THALASSA 700GBK

Cod.: 02137406 EAN: 8422248356237



- ▶ **Electronic Control Panel** with digital display, automatic shut-down timer and cleaning filters indicator
- ▶ 6 extraction levels, 5 + **1 TURBO**
- ▶ Extraction power: **811m³/h** - 346m³/h
- ▶ Motor maximum airflow free outlet: 1200m³/h
- ▶ Sound power: **50dB(A)**, maximum: 65dB(A)
- ▶ BT3 motor. Extra silent. Maximum energy consumption **280W**
- ▶ **High-efficiency lighting by intensity-adjustable two-tone warm / natural LED STRIP**
- ▶ Air purification function. Pneumatic opening
- ▶ **Energy Class: A+**

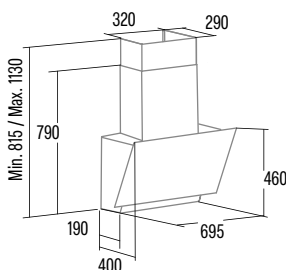

THALASSA 600GBK

Cod.: 02136406 EAN: 8422248356244



- ▶ **Electronic Control Panel** with digital display, automatic shut-down timer and cleaning filters indicator
- ▶ 6 extraction levels, 5 + **1 TURBO**
- ▶ Extraction power: **811m³/h** - 346m³/h
- ▶ Motor maximum airflow free outlet: 1200m³/h
- ▶ Sound power: **50dB(A)**, maximum: 65dB(A)
- ▶ BT3 motor. Extra silent. Maximum energy consumption **280W**
- ▶ **High-efficiency lighting by intensity-adjustable two-tone warm / natural LED STRIP**
- ▶ Air purification function. Pneumatic opening
- ▶ **Energy Class: A+**

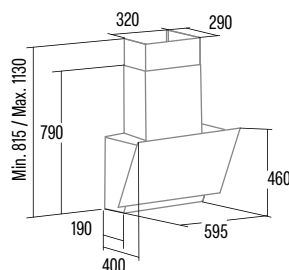

THALASSA 900GWH

Cod.: 02139006 EAN: 8422248356251



- ▶ **Electronic Control Panel** with digital display, automatic shut-down timer and cleaning filters indicator
- ▶ 6 extraction levels, 5 + **1 TURBO**
- ▶ Extraction power: **811m³/h** - 346m³/h
- ▶ Motor maximum airflow free outlet: 1200m³/h
- ▶ Sound power: **50dB(A)**, maximum: 65dB(A)
- ▶ BT3 motor. Extra silent. Maximum energy consumption **280W**
- ▶ **High-efficiency lighting by intensity-adjustable two-tone warm / natural LED STRIP**
- ▶ Air purification function. Pneumatic opening
- ▶ **Energy Class: A+**

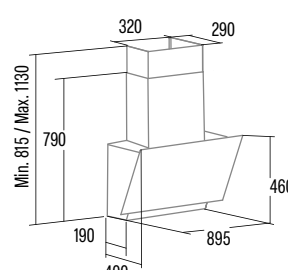

THALASSA 700GWH

Cod.: 02137006 EAN: 8422248356268



- ▶ **Electronic Control Panel** with digital display, automatic shut-down timer and cleaning filters indicator
- ▶ 6 extraction levels, 5 + **1 TURBO**
- ▶ Extraction power: **811m³/h** - 346m³/h
- ▶ Motor maximum airflow free outlet: 1200m³/h
- ▶ Sound power: **50dB(A)**, maximum: 65dB(A)
- ▶ BT3 motor. Extra silent. Maximum energy consumption **280W**
- ▶ **High-efficiency lighting by intensity-adjustable two-tone warm / natural LED STRIP**
- ▶ Air purification function. Pneumatic opening
- ▶ **Energy Class: A+**

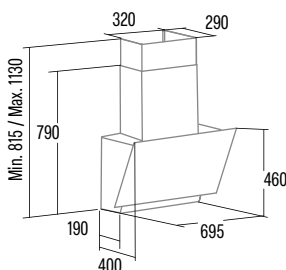

THALASSA 600GWH

Cod.: 02136006 EAN: 8422248356275



- ▶ **Electronic Control Panel** with digital display, automatic shut-down timer and cleaning filters indicator
- ▶ 6 extraction levels, 5 + **1 TURBO**
- ▶ Extraction power: **811m³/h** - 346m³/h
- ▶ Motor maximum airflow free outlet: 1200m³/h
- ▶ Sound power: **50dB(A)**, maximum: 65dB(A)
- ▶ BT3 motor. Extra silent. Maximum energy consumption **280W**
- ▶ **High-efficiency lighting by intensity-adjustable two-tone warm / natural LED STRIP**
- ▶ Air purification function. Pneumatic opening
- ▶ **Energy Class: A+**

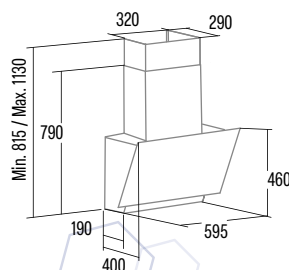

JUNO+ 9000 GBK

Cod.: 02059701 EAN: 8422248355643

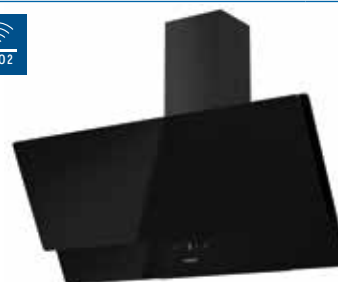

- ▶ **Electronic Control Panel** with digital display, automatic shut-down timer and cleaning filters indicator
- ▶ 6 extraction levels, 5 + **1 TURBO**
- ▶ Extraction power: **548m³/h** - 212m³/h
- ▶ Motor maximum airflow free outlet: 900m³/h
- ▶ Sound power: **50dB(A)**, maximum: 64dB(A)
- ▶ BRUSHLESS motor. Extra silent. Maximum energy consumption **95W**
- ▶ **AUTO 2 connectivity for control of the CATA AUTO 2 hobs**
- ▶ High efficiency STRIP LED lighting, adjustable intensity
- ▶ Pneumatic opening
- ▶ **Energy Class: A+**

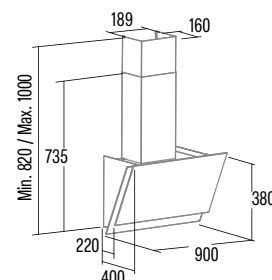

JUNO+ 7000 GBK

Cod.: 02078701 EAN: 8422248355636



- ▶ **Electronic Control Panel** with digital display, automatic shut-down timer and cleaning filters indicator
- ▶ 6 extraction levels, 5 + **1 TURBO**
- ▶ Extraction power: **548m³/h** - 212m³/h
- ▶ Motor maximum airflow free outlet: 900m³/h
- ▶ Sound power: **50dB(A)**, maximum: 64dB(A)
- ▶ BRUSHLESS motor. Extra silent. Maximum energy consumption **95W**
- ▶ **AUTO 2 connectivity for control of the CATA AUTO 2 hobs**
- ▶ High efficiency STRIP LED lighting, adjustable intensity
- ▶ Pneumatic opening
- ▶ **Energy Class: A+**

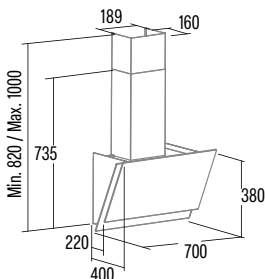

JUNO+ 6000 GBK

Cod.: 02027701 EAN: 8422248355629



- ▶ **Electronic Control Panel** with digital display, automatic shut-down timer and cleaning filters indicator
- ▶ 6 extraction levels, 5 + **1 TURBO**
- ▶ Extraction power: **548m³/h** - 212m³/h
- ▶ Motor maximum airflow free outlet: 900m³/h
- ▶ Sound power: **50dB(A)**, maximum: 64dB(A)
- ▶ BRUSHLESS motor. Extra silent. Maximum energy consumption **95W**
- ▶ **AUTO 2 connectivity for control of the CATA AUTO 2 hobs**
- ▶ High efficiency STRIP LED lighting, adjustable intensity
- ▶ Pneumatic opening
- ▶ **Energy Class: A+**

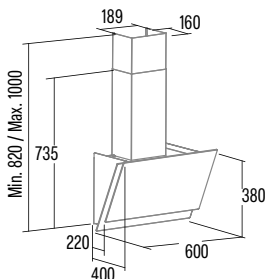

JUNO+ 9000 GWH

Cod.: 02059801 EAN: 8422248355674



- ▶ **Electronic Control Panel** with digital display, automatic shut-down timer and cleaning filters indicator
- ▶ 6 extraction levels, 5 + **1 TURBO**
- ▶ Extraction power: **548m³/h** - 212m³/h
- ▶ Motor maximum airflow free outlet: 900m³/h
- ▶ Sound power: **50dB(A)**, maximum: 64dB(A)
- ▶ BRUSHLESS motor. Extra silent. Maximum energy consumption **95W**
- ▶ **AUTO 2 connectivity for control of the CATA AUTO 2 hobs**
- ▶ High efficiency STRIP LED lighting, adjustable intensity
- ▶ Pneumatic opening
- ▶ **Energy Class: A+**

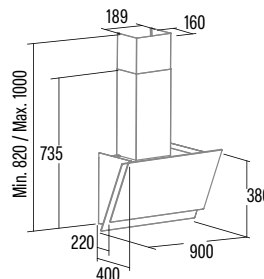

JUNO+ 7000 GWH

Cod.: 02078801 EAN: 8422248355667



- ▶ **Electronic Control Panel** with digital display, automatic shut-down timer and cleaning filters indicator
- ▶ 6 extraction levels, 5 + **1 TURBO**
- ▶ Extraction power: **548m³/h** - 212m³/h
- ▶ Motor maximum airflow free outlet: 900m³/h
- ▶ Sound power: **50dB(A)**, maximum: 64dB(A)
- ▶ BRUSHLESS motor. Extra silent. Maximum energy consumption **95W**
- ▶ **AUTO 2 connectivity for control of the CATA AUTO 2 hobs**
- ▶ High efficiency STRIP LED lighting, adjustable intensity
- ▶ Pneumatic opening
- ▶ **Energy Class: A+**

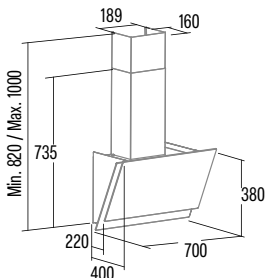

JUNO+ 6000 GWH

Cod.: 02027801 EAN: 8422248355650



- ▶ **Electronic Control Panel** with digital display, automatic shut-down timer and cleaning filters indicator
- ▶ 6 extraction levels, 5 + **1 TURBO**
- ▶ Extraction power: **548m³/h** - 212m³/h
- ▶ Motor maximum airflow free outlet: 900m³/h
- ▶ Sound power: **50dB(A)**, maximum: 64dB(A)
- ▶ BRUSHLESS motor. Extra silent. Maximum energy consumption **95W**
- ▶ **AUTO 2 connectivity for control of the CATA AUTO 2 hobs**
- ▶ High efficiency STRIP LED lighting, adjustable intensity
- ▶ Pneumatic opening
- ▶ **Energy Class: A+**

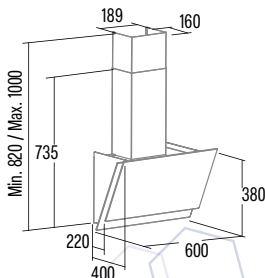

JUNO 9000 GBK

Cod.: 02059700 EAN: 8422248355612



- ▶ **Touch Control Panel** with digital display, automatic shut-down timer and cleaning filters indicator
- ▶ 6 extraction levels, 5 + **1 TURBO**
- ▶ Extraction power: **424m³/h** - 185m³/h
- ▶ Motor maximum airflow free outlet: 600m³/h
- ▶ Sound power: **45dB(A)**, maximum: 61dB(A)
- ▶ BRUSHLESS motor. Extra silent. Maximum energy consumption **73W**
- ▶ **AUTO 2 connectivity for control of the CATA AUTO 2 hobs**
- ▶ High efficiency Compact STRIP LED lighting, adjustable intensity
- ▶ **Energy Class: A+**

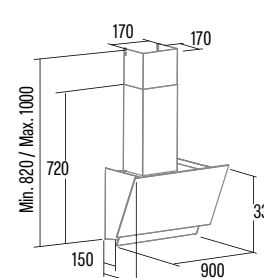

DECORATIVE HOODS

JUNO 7000 GBK

Cod.: 02078700 EAN: 8422248355605



- ▶ **Touch Control Panel** with digital display, automatic shut-down timer and cleaning filters indicator
- ▶ 6 extraction levels, 5 + 1 **TURBO**
- ▶ Extraction power: **424m³/h** - 185m³/h
- ▶ Motor maximum airflow free outlet: 600m³/h
- ▶ Sound power: **45dB(A)**, maximum: 61dB(A)
- ▶ BRUSHLESS motor. Extra silent. Maximum energy consumption **73W**
- ▶ **AUTO 2 connectivity for control of the CATA AUTO 2 hobs**
- ▶ High efficiency Compact STRIP LED lighting, adjustable intensity
- ▶ **Energy Class: A+**

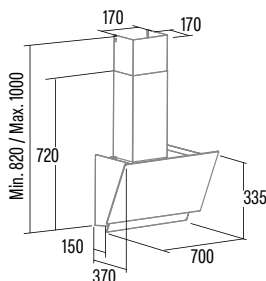

JUNO 6000 GBK

Cod.: 02027700 EAN: 8422248355599



- ▶ **Touch Control Panel** with digital display, automatic shut-down timer and cleaning filters indicator
- ▶ 6 extraction levels, 5 + 1 **TURBO**
- ▶ Extraction power: **424m³/h** - 185m³/h
- ▶ Motor maximum airflow free outlet: 600m³/h
- ▶ Sound power: **45dB(A)**, maximum: 61dB(A)
- ▶ BRUSHLESS motor. Extra silent. Maximum energy consumption **73W**
- ▶ **AUTO 2 connectivity for control of the CATA AUTO 2 hobs**
- ▶ High efficiency Compact STRIP LED lighting, adjustable intensity
- ▶ **Energy Class: A+**

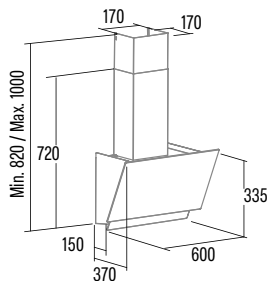

HESTIA 600 GBK

Cod.: 02012610 EAN: 8422248360395



- ▶ **Mechanical Control Panel**
- ▶ 3 extraction levels
- ▶ Extraction power: **380m³/h** - 190m³/h
- ▶ Motor maximum airflow free outlet: 450 m³/h
- ▶ Sound power: **51dB(A)**, maximum: 67dB(A)
- ▶ YL450DC motor. Maximum energy consumption **110W**
- ▶ High efficiency compact Strip LED lighting
- ▶ Max. Pressure: 206 Pa
- ▶ 120 mm outlet diameter
- ▶ **Energy Class: B**

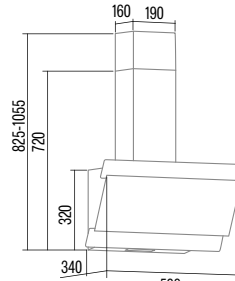

WANDA 900 XGBK

Cod.: 02059405 EAN: 8422248102308



- ▶ **Touch Control Panel** with automatic shut-down timer
- ▶ 9 extraction levels
- ▶ Extraction power: **525m³/h** - 207m³/h
- ▶ Motor maximum airflow free outlet: 1000m³/h
- ▶ Sound power: **39dB(A)**, maximum: 59dB(A)
- ▶ BRUSHLESS motor. Ultra silent. Maximum energy consumption **70W**
- ▶ High efficiency Led lighting
- ▶ **Energy Class: A++**

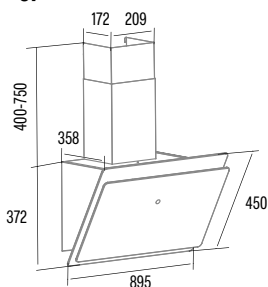

WANDA 700 XGBK

Cod.: 02078405 EAN: 8422248102315



- ▶ **Touch Control Panel** with automatic shut-down timer
- ▶ 9 extraction levels
- ▶ Extraction power: **525m³/h** - 207m³/h
- ▶ Motor maximum airflow free outlet: 1000m³/h
- ▶ Sound power: **39dB(A)**, maximum: 59dB(A)
- ▶ BRUSHLESS motor. Ultra silent. Maximum energy consumption **70W**
- ▶ High efficiency Led lighting
- ▶ **Energy Class: A++**

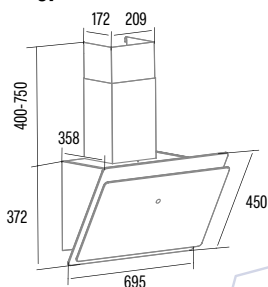

WANDA 600 XGBK

Cod.: 02027210 EAN: 8422248102322



- ▶ **Touch Control Panel** with automatic shut-down timer
- ▶ 9 extraction levels
- ▶ Extraction power: **525m³/h** - 207m³/h
- ▶ Motor maximum airflow free outlet: 1000m³/h
- ▶ Sound power: **39dB(A)**, maximum: 59dB(A)
- ▶ BRUSHLESS motor. Ultra silent. Maximum energy consumption **70W**
- ▶ High efficiency Led lighting
- ▶ **Energy Class: A++**

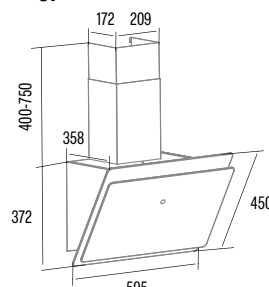

WANDA 900 XGWH

Cod.: 02059010 EAN: 8422248102339



- ▶ **Touch Control Panel** with automatic shut-down timer
- ▶ 9 extraction levels
- ▶ Extraction power: **525m³/h** - 207m³/h
- ▶ Motor maximum airflow free outlet: 1000m³/h
- ▶ Sound power: **39dB(A)**, maximum: 59dB(A)
- ▶ BRUSHLESS motor. Ultra silent. Maximum energy consumption **70W**
- ▶ High efficiency Led lighting
- ▶ **Energy Class: A++**

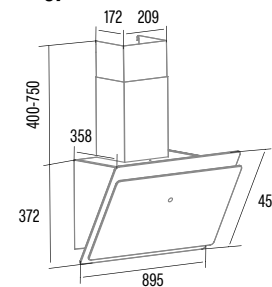

WANDA 700 XGWH

Cod.: 02078006 EAN: 8422248102346



- ▶ **Touch Control Panel** with automatic shut-down timer
- ▶ 9 extraction levels
- ▶ Extraction power: **525m³/h** - 207m³/h
- ▶ Motor maximum airflow free outlet: 1000m³/h
- ▶ Sound power: **39dB(A)**, maximum: 59dB(A)
- ▶ BRUSHLESS motor. Ultra silent. Maximum energy consumption **70W**
- ▶ High efficiency Led lighting
- ▶ **Energy Class: A++**

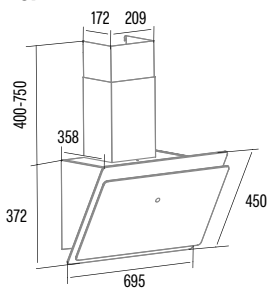

WANDA 600 XGWH

Cod.: 02027012 EAN: 8422248102353



- ▶ **Touch Control Panel** with automatic shut-down timer
- ▶ 9 extraction levels
- ▶ Extraction power: **525m³/h** - 207m³/h
- ▶ Motor maximum airflow free outlet: 1000m³/h
- ▶ Sound power: **39dB(A)**, maximum: 59dB(A)
- ▶ BRUSHLESS motor. Ultra silent. Maximum energy consumption **70W**
- ▶ High efficiency Led lighting
- ▶ **Energy Class: A++**

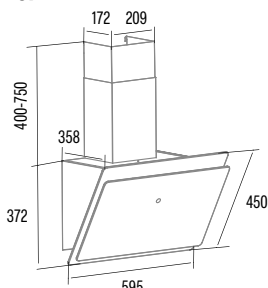

LENA 900 XGBK

Cod.: 02059403 EAN: 8422248108089



- ▶ **Touch Control Panel** with automatic shut-down timer
- ▶ 3 extraction levels
- ▶ Extraction power: **500m³/h** - 310m³/h
- ▶ Motor maximum airflow free outlet: 750m³/h
- ▶ Sound power: **45dB(A)**, maximum: 63dB(A)
- ▶ 1 motor.
- Maximum energy consumption **120W**
- ▶ High efficiency LED lighting
- ▶ Energy Class: B

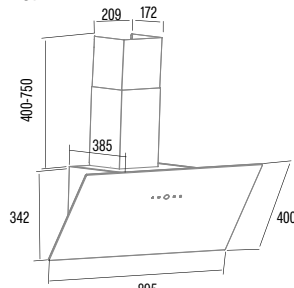

LENA 600XGBK

Cod.: 02032205 EAN: 8422248102292



- ▶ **Touch Control Panel** with automatic shut-down timer
- ▶ 3 extraction levels
- ▶ Extraction power: **500m³/h** - 310m³/h
- ▶ Motor maximum airflow free outlet: 750m³/h
- ▶ Sound power: **45dB(A)**, maximum: 63dB(A)
- ▶ 1 motor.
- Maximum energy consumption **120W**
- ▶ High efficiency LED lighting
- ▶ Energy Class: B

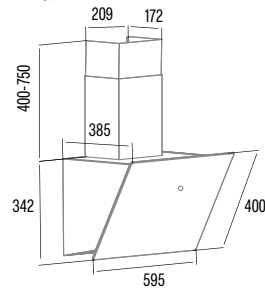

LENA 500XGBK

Cod.: 02032206 EAN: 8422248102377



- ▶ **Touch Control Panel** with automatic shut-down timer
- ▶ 3 extraction levels
- ▶ Extraction power: **500m³/h** - 310m³/h
- ▶ Motor maximum airflow free outlet: 750m³/h
- ▶ Sound power: **45dB(A)**, maximum: 63dB(A)
- ▶ 1 motor.
- Maximum energy consumption **120W**
- ▶ High efficiency LED lighting
- ▶ Energy Class: B

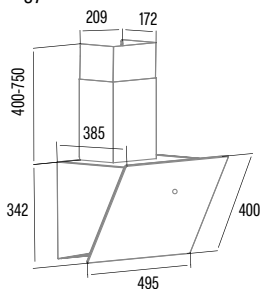

LENA 900XGWH

Cod.: 02059011 EAN: 8422248346559



- ▶ **Touch Control Panel** with automatic shut-down timer
- ▶ 3 extraction levels
- ▶ Extraction power: **500m³/h** - 310m³/h
- ▶ Motor maximum airflow free outlet: 750m³/h
- ▶ Sound power: **45dB(A)**, maximum: 63dB(A)
- ▶ 1 motor.
- Maximum energy consumption **120W**
- ▶ High efficiency LED lighting
- ▶ Energy Class: B

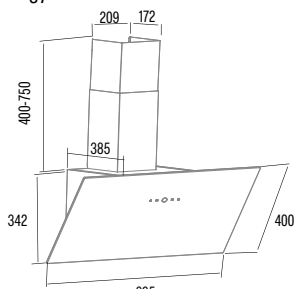

LENA 600XGWH

Cod.: 02032005 EAN: 8422248102285



- ▶ **Touch Control Panel** with automatic shut-down timer
- ▶ 3 extraction levels
- ▶ Extraction power: **500m³/h** - 310m³/h
- ▶ Motor maximum airflow free outlet: 750m³/h
- ▶ Sound power: **45dB(A)**, maximum: 63dB(A)
- ▶ 1 motor.
- Maximum energy consumption **120W**
- ▶ High efficiency LED lighting
- ▶ Energy Class: B

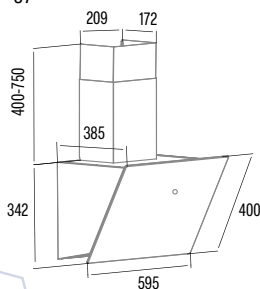

LENA 500XGWH

Cod.: 02032006 EAN: 8422248102360



- ▶ **Touch Control Panel** with automatic shut-down timer
- ▶ 3 extraction levels
- ▶ Extraction power: **500m³/h** - 310m³/h
- ▶ Motor maximum airflow free outlet: 750m³/h
- ▶ Sound power: **45dB(A)**, maximum: 63dB(A)
- ▶ 1 motor.
- Maximum energy consumption **120W**
- ▶ High efficiency LED lighting
- ▶ Energy Class: B

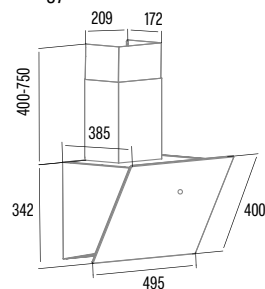

DECORATIVE HOODS

LEGEND 9000 XGBK

Cod.: 02029207 EAN: 8422248101493



- ▶ **Touch Control Panel** with automatic shut-down timer and cleaning filters indicator
- ▶ 9 extraction levels
- ▶ Extraction power: **640m³/h** -236m³/h
- ▶ Motor maximum airflow free outlet: 1000m³/h
- ▶ Sound power: **44dB(A)**, maximum: 65dB(A)
- ▶ BRUSHLESS motor. Ultra silent.
- ▶ Maximum energy consumption **70W**
- ▶ High efficiency STRIP LED lighting
- ▶ **Energy Class: A++**

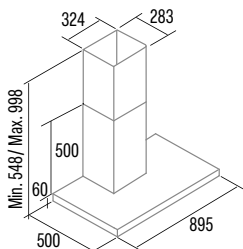

LEGEND 7000 XGBK

Cod.: 02021202 EAN: 8422248101509



- ▶ **Touch Control Panel** with automatic shut-down timer and cleaning filters indicator
- ▶ 9 extraction levels
- ▶ Extraction power: **640m³/h** -236m³/h
- ▶ Motor maximum airflow free outlet: 1000m³/h
- ▶ Sound power: **44dB(A)**, maximum: 65dB(A)
- ▶ BRUSHLESS motor. Ultra silent.
- ▶ Maximum energy consumption **70W**
- ▶ High efficiency STRIP LED lighting
- ▶ **Energy Class: A++**

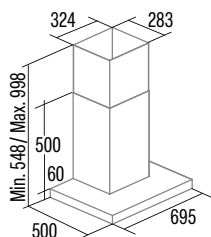

LEGEND 6000 XGBK

Cod.: 02060208 EAN: 8422248102544



- ▶ **Touch Control Panel** with automatic shut-down timer and cleaning filters indicator
- ▶ 9 extraction levels
- ▶ Extraction power: **640m³/h** -236m³/h
- ▶ Motor maximum airflow free outlet: 1000m³/h
- ▶ Sound power: **44dB(A)**, maximum: 65dB(A)
- ▶ BRUSHLESS motor. Ultra silent.
- ▶ Maximum energy consumption **70W**
- ▶ High efficiency STRIP LED lighting
- ▶ **Energy Class: A++**

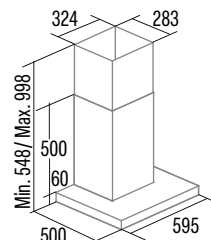

LEGEND 9010 X

Cod.: 02029306 EAN: 8422248110037



- ▶ **Electronic Control Panel** with digital display, automatic shut-down timer and cleaning filters indicator
- ▶ 6 extraction levels, 5 + **1 TURBO**
- ▶ Extraction power: **831m³/h** - 210m³/h
- ▶ Motor maximum airflow free outlet: 1100m³/h
- ▶ Sound power: **40dB(A)**, máximo: 64dB(A)
- ▶ BT5DC motor. Extra silent.
- ▶ Maximum energy consumption **140W**
- ▶ High efficiency strip Led lighting, adjustable intensity
- ▶ **Energy Class: A++**

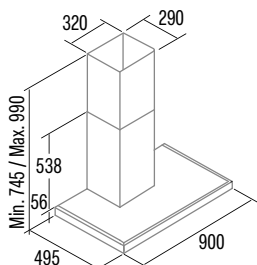

LEGEND 7010 X

Cod.: 02021308 EAN: 8422248110044



- ▶ **Electronic Control Panel** with digital display, automatic shut-down timer and cleaning filters indicator
- ▶ 6 extraction levels, 5 + **1 TURBO**
- ▶ Extraction power: **831m³/h** - 210m³/h
- ▶ Motor maximum airflow free outlet: 1100m³/h
- ▶ Sound power: **40dB(A)**, máximo: 64dB(A)
- ▶ BT5DC motor. Extra silent.
- ▶ Maximum energy consumption **140W**
- ▶ High efficiency strip Led lighting, adjustable intensity
- ▶ **Energy Class: A++**

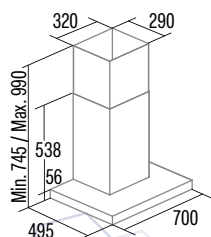

SYGMA 12010 X

Cod.: 02132305 EAN: 8422248073035



- ▶ **Electronic control Panel** with automatic shut down timer
- ▶ 4 extraction levels, 3 + **1 TURBO**
- ▶ Extraction power: **802m³/h** - 340m³/h
- ▶ Motor maximum airflow free outlet: 1350m³/h
- ▶ Sound power: **50dB(A)**, maximum: 67dB(A)
- ▶ BT3 motor. Extra silent.
- ▶ Maximum energy consumption **280W**
- ▶ High efficiency STRIP LED lighting, adjustable intensity
- ▶ **Energy Class: A**

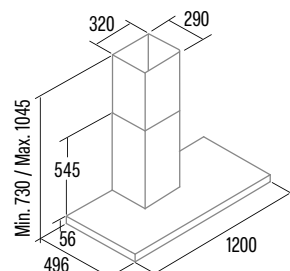

SYGMA 9010 X

Cod.: **02075305** EAN: **8422248110051**



- ▶ **Electronic control Panel** with automatic shut down timer
- ▶ 4 extraction levels, 3 + **1 TURBO**
- ▶ Extraction power: **802m³/h** - 340m³/h
- ▶ Motor maximum airflow free outlet: 1350m³/h
- ▶ Sound power: **50dB(A)**, maximum: 67dB(A)
- ▶ BT3 motor. Extra silent.
- ▶ Maximum energy consumption **280W**
- ▶ High efficiency STRIP LED lighting, adjustable intensity
- ▶ **Energy Class: A**

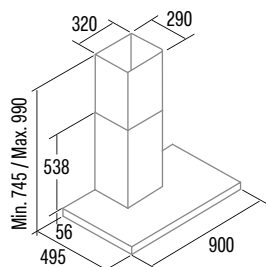

SYGMA 7010 X

Cod.: **02021310** EAN: **8422248110068**



- ▶ **Electronic control Panel** with automatic shut down timer
- ▶ 4 extraction levels, 3 + **1 TURBO**
- ▶ Extraction power: **802m³/h** - 340m³/h
- ▶ Motor maximum airflow free outlet: 1350m³/h
- ▶ Sound power: **50dB(A)**, maximum: 67dB(A)
- ▶ BT3 motor. Extra silent.
- ▶ Maximum energy consumption **280W**
- ▶ High efficiency STRIP LED lighting, adjustable intensity
- ▶ **Energy Class: A**

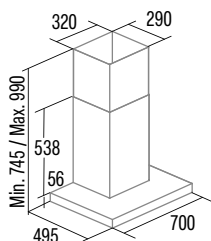

SYGMA 6010 X

Cod.: **02060310** EAN: **8422248110075**



- ▶ **Electronic control Panel** with automatic shut down timer
- ▶ 4 extraction levels, 3 + **1 TURBO**
- ▶ Extraction power: **802m³/h** - 340m³/h
- ▶ Motor maximum airflow free outlet: 1350m³/h
- ▶ Sound power: **50dB(A)**, maximum: 67dB(A)
- ▶ BT3 motor. Extra silent.
- ▶ Maximum energy consumption **280W**
- ▶ High efficiency STRIP LED lighting, adjustable intensity
- ▶ **Energy Class: A**

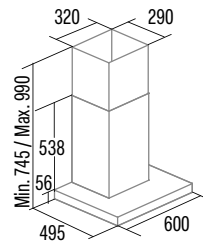

SYGMA 9010 BK

Cod.: **02075401** EAN: **8422248110082**



- ▶ **Electronic control Panel** with automatic shut down timer
- ▶ 4 extraction levels, 3 + **1 TURBO**
- ▶ Extraction power: **802m³/h** - 340m³/h
- ▶ Motor maximum airflow free outlet: 1350m³/h
- ▶ Sound power: **50dB(A)**, maximum: 67dB(A)
- ▶ BT3 motor. Extra silent.
- ▶ Maximum energy consumption **280W**
- ▶ High efficiency STRIP LED lighting, adjustable intensity
- ▶ **Energy Class: A**

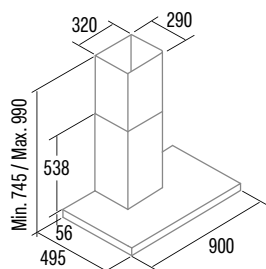

SYGMA 7010 BK

Cod.: **02021400** EAN: **8422248357272**



- ▶ **Electronic control Panel** with automatic shut down timer
- ▶ 4 extraction levels, 3 + **1 TURBO**
- ▶ Extraction power: **802m³/h** - 340m³/h
- ▶ Motor maximum airflow free outlet: 1350m³/h
- ▶ Sound power: **50dB(A)**, maximum: 67dB(A)
- ▶ BT3 motor. Extra silent.
- ▶ Maximum energy consumption **280W**
- ▶ High efficiency STRIP LED lighting, adjustable intensity
- ▶ **Energy Class: A**

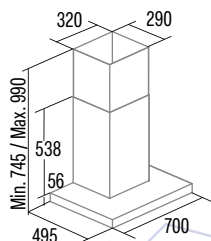

SYGMA 6010 BK

Cod.: **02060400** EAN: **8422248357289**



- ▶ **Electronic control Panel** with automatic shut down timer
- ▶ 4 extraction levels, 3 + **1 TURBO**
- ▶ Extraction power: **802m³/h** - 340m³/h
- ▶ Motor maximum airflow free outlet: 1350m³/h
- ▶ Sound power: **50dB(A)**, maximum: 67dB(A)
- ▶ BT3 motor. Extra silent.
- ▶ Maximum energy consumption **280W**
- ▶ High efficiency STRIP LED lighting, adjustable intensity
- ▶ **Energy Class: A**

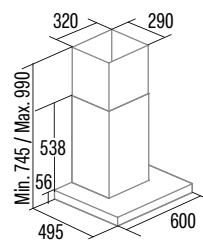

S PRO 9000 X

Cod.: **02075410** EAN: **8422248371421**



NEW

- ▶ **Electronic Control Panel** with digital display, automatic shut-down timer
- ▶ 3 extraction levels, 2 + 1 TURBO
- ▶ Extraction power: **1027m³/h** - 419m³/h
- ▶ Sound power: **64dB(A)**, máximo: 76dB(A)
- ▶ A1000 motor. Extra silent.
- Maximum energy consumption **380W**
- ▶ High efficiency LED lighting
- ▶ **Energy Class: A**

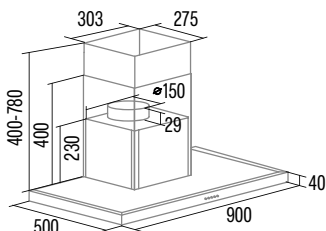

S PRO 7000 X

Cod.: **02075411** EAN: **8422248371438**



NEW

- ▶ **Electronic Control Panel** with digital display, automatic shut-down timer
- ▶ 3 extraction levels, 2 + 1 TURBO
- ▶ Extraction power: **1027m³/h** - 419m³/h
- ▶ Sound power: **64dB(A)**, máximo: 76dB(A)
- ▶ A1000 motor. Extra silent.
- Maximum energy consumption **380W**
- ▶ High efficiency LED lighting
- ▶ **Energy Class: A**

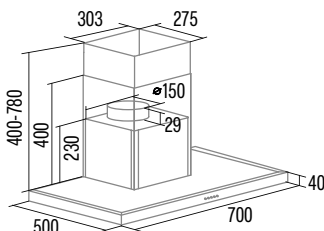

S PRO 6000 X

Cod.: **02075412** EAN: **8422248371445**



NEW

- ▶ **Electronic Control Panel** with digital display, automatic shut-down timer
- ▶ 3 extraction levels, 2 + 1 TURBO
- ▶ Extraction power: 1027m³/h - 419m³/h
- ▶ Sound power: **64dB(A)**, máximo: 76dB(A)
- ▶ A1000 motor. Extra silent.
- Maximum energy consumption **380W**
- ▶ High efficiency LED lighting
- ▶ **Energy Class: A**

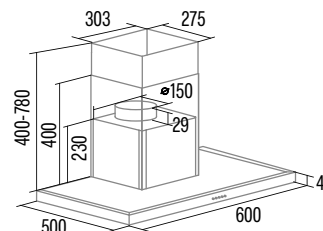

S PRO 9000 BK

Cod.: **02075413** EAN: **8422248371452**



NEW

- ▶ **Electronic Control Panel** with digital display, automatic shut-down timer
- ▶ 3 extraction levels, 2 + 1 TURBO
- ▶ Extraction power: **1027m³/h** - 419m³/h
- ▶ Sound power: **64dB(A)**, máximo: 76dB(A)
- ▶ A1000 motor. Extra silent.
- Maximum energy consumption **380W**
- ▶ High efficiency LED lighting
- ▶ **Energy Class: A**

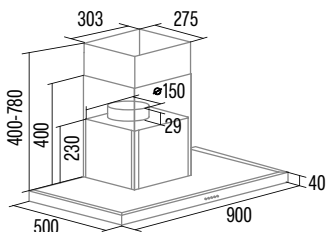

S PRO 7000 BK

Cod.: **02075414** EAN: **8422248371476**



NEW

- ▶ **Electronic Control Panel** with digital display, automatic shut-down timer
- ▶ 3 extraction levels, 2 + 1 TURBO
- ▶ Extraction power: **1027m³/h** - 419m³/h
- ▶ Sound power: **64dB(A)**, máximo: 76dB(A)
- ▶ A1000 motor. Extra silent.
- Maximum energy consumption **380W**
- ▶ High efficiency LED lighting
- ▶ **Energy Class: A**

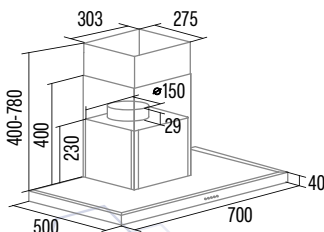

S PRO 6000 BK

Cod.: **02075415** EAN: **8422248371506**



NEW

- ▶ **Electronic Control Panel** with digital display, automatic shut-down timer
- ▶ 3 extraction levels, 2 + 1 TURBO
- ▶ Extraction power: **1027m³/h** - 419m³/h
- ▶ Sound power: **64dB(A)**, máximo: 76dB(A)
- ▶ A1000 motor. Extra silent.
- Maximum energy consumption **380W**
- ▶ High efficiency LED lighting
- ▶ **Energy Class: A**

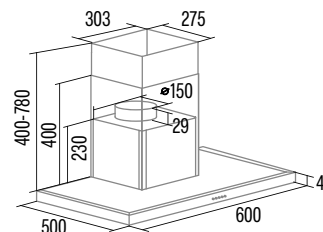

S PLUS 9010 X

Cod.: **02029602** EAN: **8422248093422**



- ▶ **Mechanical Control Panel**
- ▶ 3 extraction levels
- ▶ Extraction power: **637m³/h** - 361m³/h
- ▶ Motor maximum airflow free outlet: 1150m³/h
- ▶ Sound power: **69dB(A)**, maximum: 74dB(A)
- ▶ Motor M3R. Extra silent.
- ▶ Maximum energy consumption **270W**
- ▶ High efficiency Compact Strip LED lighting
- ▶ Energy Class: C

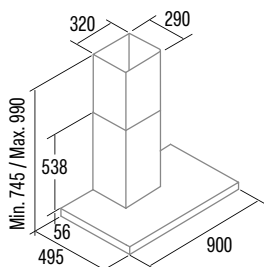

S PLUS 7010 X

Cod.: **02021602** EAN: **8422248093446**



- ▶ **Mechanical Control Panel**
- ▶ 3 extraction levels
- ▶ Extraction power: **637m³/h** - 361m³/h
- ▶ Motor maximum airflow free outlet: 1150m³/h
- ▶ Sound power: **69dB(A)**, maximum: 74dB(A)
- ▶ Motor M3R. Extra silent.
- ▶ Maximum energy consumption **270W**
- ▶ High efficiency Compact Strip LED lighting
- ▶ Energy Class: C

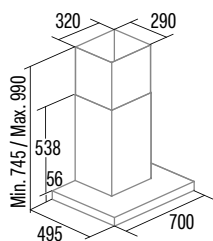

S PLUS 6010 X

Cod.: **02060602** EAN: **8422248093453**



- ▶ **Mechanical Control Panel**
- ▶ 3 extraction levels
- ▶ Extraction power: **637m³/h** - 361m³/h
- ▶ Motor maximum airflow free outlet: 1150m³/h
- ▶ Sound power: **69dB(A)**, maximum: 74dB(A)
- ▶ Motor M3R. Extra silent.
- ▶ Maximum energy consumption **270W**
- ▶ High efficiency Compact Strip LED lighting
- ▶ Energy Class: C

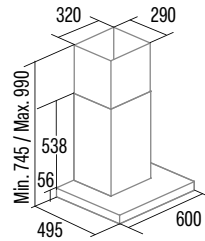

ST-9000 X

Cod.: **02029309** EAN: **8422248108706**



- ▶ **Mechanical Control Panel**
- ▶ 3 extraction levels
- ▶ Extraction power: **302m³/h** - 165m³/h
- ▶ Motor maximum airflow free outlet: 360m³/h
- ▶ Sound power: **58dB(A)**, maximum: 62dB(A)
- ▶ Maximum energy consumption **65W**
- ▶ High efficiency STRIP LED lighting
- ▶ Energy Class: C

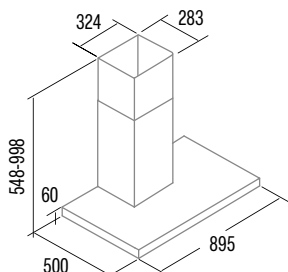

ST-7000 X

Cod.: **02021309** EAN: **8422248108690**



- ▶ **Mechanical Control Panel**
- ▶ 3 extraction levels
- ▶ Extraction power: **302m³/h** - 165m³/h
- ▶ Motor maximum airflow free outlet: 360m³/h
- ▶ Sound power: **58dB(A)**, maximum: 62dB(A)
- ▶ Maximum energy consumption **65W**
- ▶ High efficiency STRIP LED lighting
- ▶ Energy Class: C

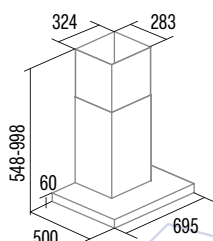

ST-6000 X

Cod.: **02060309** EAN: **8422248108683**



- ▶ **Mechanical Control Panel**
- ▶ 3 extraction levels
- ▶ Extraction power: **302m³/h** - 165m³/h
- ▶ Motor maximum airflow free outlet: 360m³/h
- ▶ Sound power: **58dB(A)**, maximum: 62dB(A)
- ▶ Maximum energy consumption **65W**
- ▶ High efficiency STRIP LED lighting
- ▶ Energy Class: C

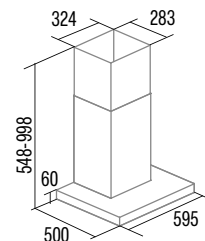

SK 6000 X

Cod.: **02060609** EAN: **8422248356978**



- ▶ **Mechanical Control Panel**
- ▶ 3 extraction levels
- ▶ Extraction power: **380m³/h** - 166m³/h
- ▶ Motor maximum airflow free outlet: 400m³/h
- ▶ Sound power: **52dB(A)**, maximum: 68dB(A)
- ▶ K10 motor. Maximum energy consumption **93W**
- ▶ High efficiency STRIP LED lighting
- ▶ **Energy Class: A**

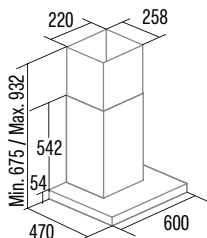

CK 9000 X

Cod.: **02008107** EAN: **8422248356992**



- ▶ **Mechanical Control Panel**
- ▶ 3 extraction levels
- ▶ Extraction power: **380m³/h** - 166m³/h
- ▶ Motor maximum airflow free outlet: 400m³/h
- ▶ Sound power: **52dB(A)**, maximum: 68dB(A)
- ▶ K10 motor. Maximum energy consumption **93W**
- ▶ High efficiency STRIP LED lighting
- ▶ **Energy Class: A**

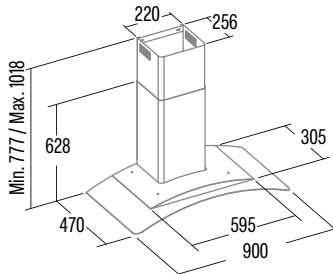

CK 6000 X

Cod.: **02005107** EAN: **8422248356985**



- ▶ **Mechanical Control Panel**
- ▶ 3 extraction levels
- ▶ Extraction power: **380m³/h** - 166m³/h
- ▶ Motor maximum airflow free outlet: 400m³/h
- ▶ Sound power: **52dB(A)**, maximum: 68dB(A)
- ▶ K10 motor. Maximum energy consumption **93W**
- ▶ High efficiency STRIP LED lighting
- ▶ **Energy Class: A**

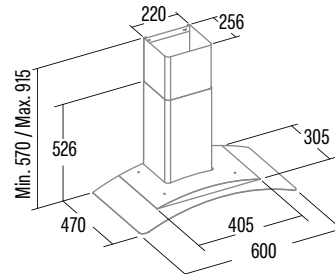

CK 6000 BK

Cod.: **02005407** EAN: **8422248357005**



- ▶ **Mechanical Control Panel**
- ▶ 3 extraction levels
- ▶ Extraction power: **380m³/h** - 166m³/h
- ▶ Motor maximum airflow free outlet: 400m³/h
- ▶ Sound power: **52dB(A)**, maximum: 68dB(A)
- ▶ K10 motor. Maximum energy consumption **93W**
- ▶ High efficiency STRIP LED lighting
- ▶ **Energy Class: A**

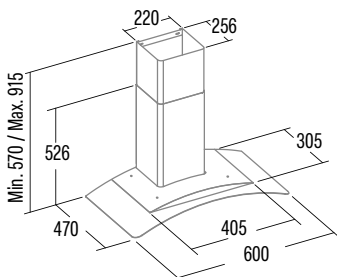

CG5-T900 X

Cod.: **02008299** EAN: **8422248108102**



- ▶ **Mechanical Control Panel**
- ▶ 3 extraction levels
- ▶ Extraction power: **495m³/h** - 300 m³/h
- ▶ Motor maximum airflow free outlet: 517m³/h
- ▶ Sound power: **45dB(A)**, maximum: 66dB(A)
- ▶ Maximum energy consumption **120W**
- ▶ High efficiency LED lighting
- ▶ Energy Class: B

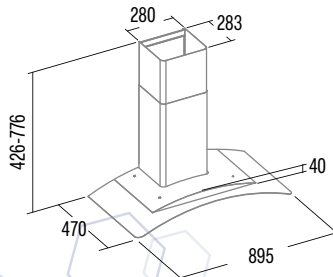

CG5-T600 X

Cod.: **02005299** EAN: **8422248097413**



- ▶ **Mechanical Control Panel**
- ▶ 3 extraction levels
- ▶ Extraction power: **495m³/h** - 300 m³/h
- ▶ Motor maximum airflow free outlet: 517m³/h
- ▶ Sound power: **45dB(A)**, maximum: 66dB(A)
- ▶ Maximum energy consumption **120W**
- ▶ High efficiency LED lighting
- ▶ Energy Class: B

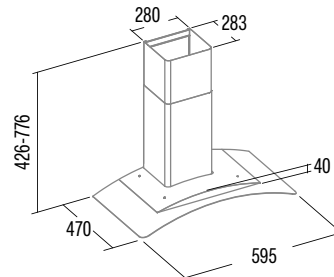

CHIMNEY

BETA PRO 9000 X

Cod.: **02075416** EAN: **8422248371513**



NEW

- ▶ **Electronic Control Panel** with digital display, automatic shut-down timer and cleaning filters indicator
- ▶ 3 extraction levels, 2 + **1 TURBO**
- ▶ Extraction power: **1027m³/h** - 419m³/h
- ▶ Sound power: **64dB(A)**, máximo: 76dB(A)
- ▶ A1000 motor. Extra silent.
- Maximum energy consumption **380W**
- ▶ High efficiency LED lighting
- ▶ **Energy Class: A**

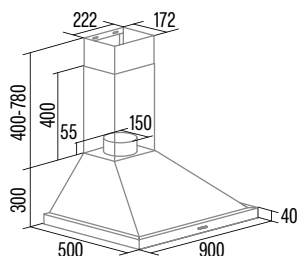

BETA PRO 7000 X

Cod.: **02075417** EAN: **8422248371520**



NEW

- ▶ **Electronic Control Panel** with digital display, automatic shut-down timer and cleaning filters indicator
- ▶ 3 extraction levels, 2 + **1 TURBO**
- ▶ Extraction power: **1027m³/h** - 419m³/h
- ▶ Sound power: **64dB(A)**, máximo: 76dB(A)
- ▶ A1000 motor. Extra silent.
- Maximum energy consumption **380W**
- ▶ High efficiency LED lighting
- ▶ **Energy Class: A**

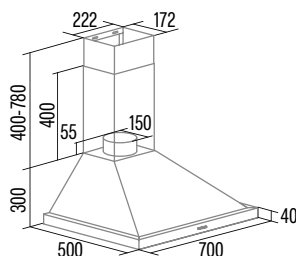

BETA PRO 6000 X

Cod.: **02075418** EAN: **8422248371537**



NEW

- ▶ **Electronic Control Panel** with digital display, automatic shut-down timer and cleaning filters indicator
- ▶ 3 extraction levels, 2 + **1 TURBO**
- ▶ Extraction power: **1027m³/h** - 419m³/h
- ▶ Sound power: **64dB(A)**, máximo: 76dB(A)
- ▶ A1000 motor. Extra silent.
- Maximum energy consumption **380W**
- ▶ High efficiency LED lighting
- ▶ **Energy Class: A**

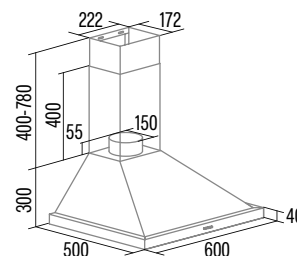

BETA PRO 9000 BK

Cod.: **02075419** EAN: **8422248371544**



NEW

- ▶ **Electronic Control Panel** with digital display, automatic shut-down timer and cleaning filters indicator
- ▶ 3 extraction levels, 2 + **1 TURBO**
- ▶ Extraction power: **1027m³/h** - 419m³/h
- ▶ Sound power: **64dB(A)**, máximo: 76dB(A)
- ▶ A1000 motor. Extra silent.
- Maximum energy consumption **380W**
- ▶ High efficiency LED lighting
- ▶ **Energy Class: A**

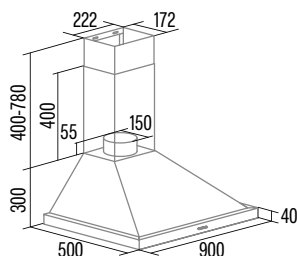

BETA PRO 7000 BK

Cod.: **02075420** EAN: **8422248371551**



NEW

- ▶ **Electronic Control Panel** with digital display, automatic shut-down timer and cleaning filters indicator
- ▶ 3 extraction levels, 2 + **1 TURBO**
- ▶ Extraction power: **1027m³/h** - 419m³/h
- ▶ Sound power: **64dB(A)**, máximo: 76dB(A)
- ▶ A1000 motor. Extra silent.
- Maximum energy consumption **380W**
- ▶ High efficiency LED lighting
- ▶ **Energy Class: A**

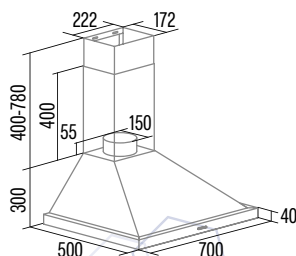

BETA PRO 6000 BK

Cod.: **02075421** EAN: **8422248371568**



NEW

- ▶ **Electronic Control Panel** with digital display, automatic shut-down timer and cleaning filters indicator
- ▶ 3 extraction levels, 2 + **1 TURBO**
- ▶ Extraction power: **1027m³/h** - 419m³/h
- ▶ Sound power: **64dB(A)**, máximo: 76dB(A)
- ▶ A1000 motor. Extra silent.
- Maximum energy consumption **380W**
- ▶ High efficiency LED lighting
- ▶ **Energy Class: A**

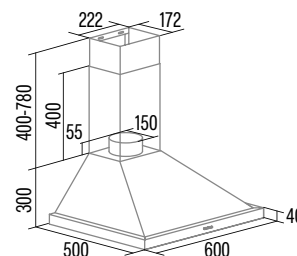



OMEGA 900 X

Cod.: **02004310** EAN: **8422248190596**



- ▶ **Mechanical control panel**
- ▶ 3 extraction levels
- ▶ Extraction power: **645m³/h** - 385m³/h
- ▶ Motor maximum airflow free outlet: 1100m³/h
- ▶ Sound power: **58dB(A)**, maximum: 72dB(A)
- ▶ M3R motor. Extra silent.
- ▶ Maximum energy consumption **270W**
- ▶ High efficiency Compact STRIP LED lighting
- ▶ Energy Class: C

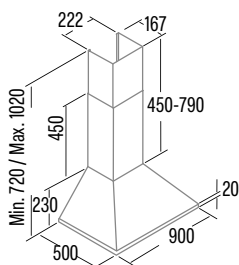

OMEGA 7500 X

Cod.: **02003307** EAN: **8422248101615**



- ▶ **Mechanical control panel**
- ▶ 3 extraction levels
- ▶ Extraction power: **595m³/h** - 410m³/h
- ▶ Motor maximum airflow free outlet: 1100m³/h
- ▶ Sound power: **58dB(A)**, maximum: 68dB(A)
- ▶ 1 motor. Maximum energy consumption **200W**
- ▶ High efficiency Compact STRIP LED lighting
- ▶ **Energy Class: A**

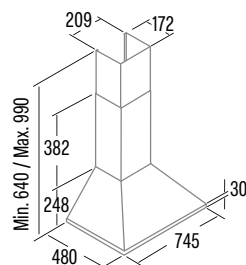

OMEGA 700 X

Cod.: **02003310** EAN: **8422248190602**



- ▶ **Mechanical control panel**
- ▶ 3 extraction levels
- ▶ Extraction power: **645m³/h** - 385m³/h
- ▶ Motor maximum airflow free outlet: 1100m³/h
- ▶ Sound power: **58dB(A)**, maximum: 72dB(A)
- ▶ M3R motor. Extra silent.
- ▶ Maximum energy consumption **270W**
- ▶ High efficiency Compact STRIP LED lighting
- ▶ Energy Class: C

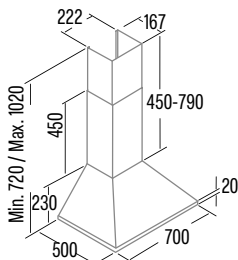

OMEGA 600 X

Cod.: **02002310** EAN: **8422248109826**



- ▶ **Mechanical control panel**
- ▶ 3 extraction levels
- ▶ Extraction power: **645m³/h** - 385m³/h
- ▶ Motor maximum airflow free outlet: 1100m³/h
- ▶ Sound power: **58dB(A)**, maximum: 72dB(A)
- ▶ M3R motor. Extra silent.
- ▶ Maximum energy consumption **270W**
- ▶ High efficiency Compact STRIP LED lighting
- ▶ Energy Class: C

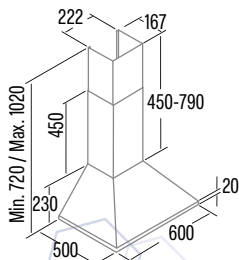

OMEGA 900 BK

Cod.: **02004410** EAN: **8422248190633**



- ▶ **Mechanical control panel**
- ▶ 3 extraction levels
- ▶ Extraction power: **645m³/h** - 385m³/h
- ▶ Motor maximum airflow free outlet: 1100m³/h
- ▶ Sound power: **58dB(A)**, maximum: 72dB(A)
- ▶ M3R motor. Extra silent.
- ▶ Maximum energy consumption **270W**
- ▶ High efficiency Compact STRIP LED lighting
- ▶ Energy Class: C

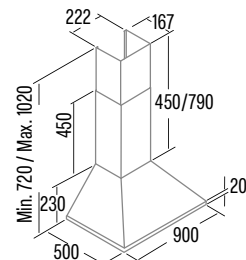

OMEGA 600 BK

Cod.: **02002410** EAN: **8422248109833**



- ▶ **Mechanical control panel**
- ▶ 3 extraction levels
- ▶ Extraction power: **645m³/h** - 385m³/h
- ▶ Motor maximum airflow free outlet: 1100m³/h
- ▶ Sound power: **58dB(A)**, maximum: 72dB(A)
- ▶ M3R motor. Extra silent.
- ▶ Maximum energy consumption **270W**
- ▶ High efficiency Compact STRIP LED lighting
- ▶ Energy Class: C

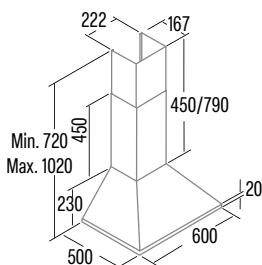

OMEGA 900 WH

Cod.: **02004010** EAN: **8422248190619**



- ▶ **Mechanical control panel**
- ▶ 3 extraction levels
- ▶ Extraction power: **645m³/h** - 385m³/h
- ▶ Motor maximum airflow free outlet: 1100m³/h
- ▶ Sound power: **58dB(A)**, maximum: 72dB(A)
- ▶ M3R motor. Extra silent.
- ▶ Maximum energy consumption **270W**
- ▶ High efficiency Compact STRIP LED lighting
- ▶ Energy Class: C

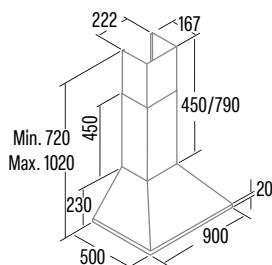

OMEGA 700 WH

Cod.: **02003010** EAN: **8422248190626**



- ▶ **Mechanical control panel**
- ▶ 3 extraction levels
- ▶ Extraction power: **645m³/h** - 385m³/h
- ▶ Motor maximum airflow free outlet: 1100m³/h
- ▶ Sound power: **58dB(A)**, maximum: 72dB(A)
- ▶ M3R motor. Extra silent.
- ▶ Maximum energy consumption **270W**
- ▶ High efficiency Compact STRIP LED lighting
- ▶ Energy Class: C

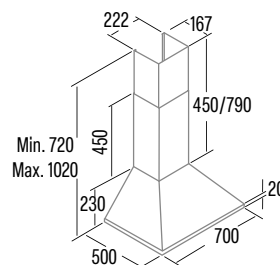

OMEGA 600 WH

Cod.: **02002010** EAN: **8422248109819**



- ▶ **Mechanical control panel**
- ▶ 3 extraction levels
- ▶ Extraction power: **645m³/h** - 385m³/h
- ▶ Motor maximum airflow free outlet: 1100m³/h
- ▶ Sound power: **58dB(A)**, maximum: 72dB(A)
- ▶ M3R motor. Extra silent.
- ▶ Maximum energy consumption **270W**
- ▶ High efficiency Compact STRIP LED lighting
- ▶ Energy Class: C

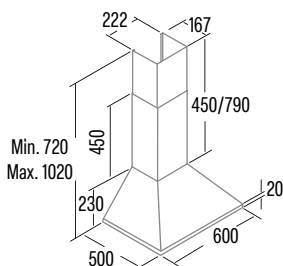

VK 9000 X

Cod.: **02063603** EAN: **8422248371186**



- ▶ **Mechanical Control Panel**
- ▶ 3 extraction levels
- ▶ Extraction power: **480m³/h** - 175m³/h
- ▶ Motor maximum airflow free outlet: 400m³/h
- ▶ Sound power: **56dB(A)**, maximum: 69dB(A)
- ▶ K10 motor. Maximum energy consumption **110W**
- ▶ High efficiency compact Strip Led lighting
- ▶ **Energy Class: A**

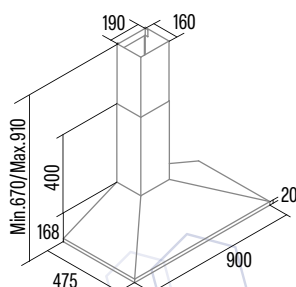

VK 7000 X

Cod.: **02085602** EAN: **8422248371193**



- ▶ **Mechanical Control Panel**
- ▶ 3 extraction levels
- ▶ Extraction power: **480m³/h** - 175m³/h
- ▶ Motor maximum airflow free outlet: 400m³/h
- ▶ Sound power: **56dB(A)**, maximum: 69dB(A)
- ▶ K10 motor. Maximum energy consumption **110W**
- ▶ High efficiency compact Strip Led lighting
- ▶ **Energy Class: A**

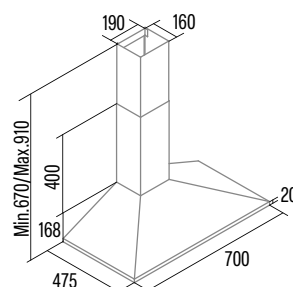

VK 6000 X

Cod.: 02061606 EAN: 8422248357012



NEW

- ▶ **Mechanical Control Panel**
- ▶ 3 extraction levels
- ▶ Extraction power: **480m³/h** - 175m³/h
- ▶ Motor maximum airflow free outlet: 650m³/h
- ▶ Sound power: **56dB(A)**, maximum: 69dB(A)
- ▶ K10 motor. Maximum energy consumption **110W**
- ▶ High efficiency compact Strip Led lighting
- ▶ **Energy Class: A**

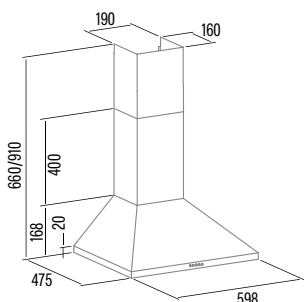

VK 6000 X +FCA

Cod.: 02061608 EAN: 8422248371209



NEW

- ▶ **Mechanical Control Panel**
- ▶ 3 extraction levels
- ▶ Extraction power: **480m³/h** - 175m³/h
- ▶ Motor maximum airflow free outlet: 650m³/h
- ▶ Sound power: **56dB(A)**, maximum: 69dB(A)
- ▶ K10 motor. Maximum energy consumption **110W**
- ▶ High efficiency compact Strip Led lighting
- ▶ **Carbon filter included**
- ▶ **Energy Class: A**

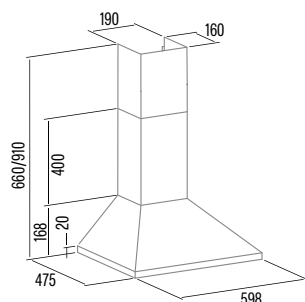

VK 6000 WH

Cod.: 02061105 EAN: 8422248357081



NEW

- ▶ **Mechanical Control Panel**
- ▶ 3 extraction levels
- ▶ Extraction power: **480m³/h** - 175m³/h
- ▶ Motor maximum airflow free outlet: 650m³/h
- ▶ Sound power: **56dB(A)**, maximum: 69dB(A)
- ▶ K10 motor. Maximum energy consumption **110W**
- ▶ High efficiency compact Strip Led lighting
- ▶ **Energy Class: A**

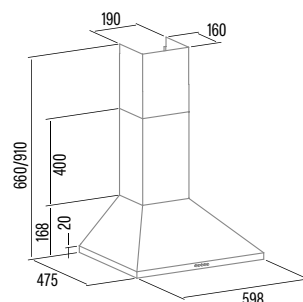

VK 6000 BK

Cod.: 02061405 EAN: 8422248357074



NEW

- ▶ **Mechanical Control Panel**
- ▶ 3 extraction levels
- ▶ Extraction power: **480m³/h** - 175m³/h
- ▶ Motor maximum airflow free outlet: 650m³/h
- ▶ Sound power: **56dB(A)**, maximum: 69dB(A)
- ▶ K10 motor. Maximum energy consumption **110W**
- ▶ High efficiency compact Strip Led lighting
- ▶ **Energy Class: A**

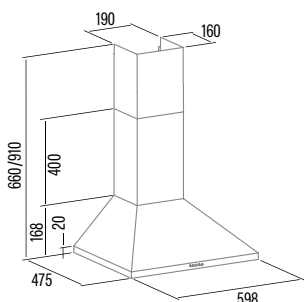

VK 5000 X

Cod.: 02088307 EAN: 8422248371216



NEW

- ▶ **Mechanical Control Panel**
- ▶ 3 extraction levels
- ▶ Extraction power: **480m³/h** - 175m³/h
- ▶ Motor maximum airflow free outlet: 650m³/h
- ▶ Sound power: **56dB(A)**, maximum: 69dB(A)
- ▶ K10 motor. Maximum energy consumption **110W**
- ▶ High efficiency compact Strip Led lighting
- ▶ **Energy Class: A**

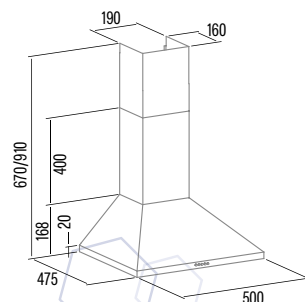

V3-T900 X

Cod.: 02063399 EAN: 8422248095303



- ▶ **Mechanical control panel**
- ▶ 3 extraction levels
- ▶ Extraction power: **335m³/h** - 166m³/h
- ▶ Motor maximum airflow free outlet: 360m³/h
- ▶ Sound power: **51dB(A)**, maximum: 66dB(A)
- ▶ 1 motor. Extra silent.
- ▶ Maximum energy consumption **65W**
- ▶ High efficiency Compact STRIP LED lighting
- ▶ Energy Class: B

V3-T600 X

Cod.: 02061399 EAN: 8422248095273



- ▶ **Mechanical control panel**
- ▶ 3 extraction levels
- ▶ Extraction power: **335m³/h** - 166m³/h
- ▶ Motor maximum airflow free outlet: 360m³/h
- ▶ Sound power: **51dB(A)**, maximum: 66dB(A)
- ▶ 1 motor. Extra silent.
- ▶ Maximum energy consumption **65W**
- ▶ High efficiency Compact STRIP LED lighting
- ▶ Energy Class: B

V3-T600 WH

Cod.: 02061799 EAN: 8422248110198



- ▶ **Mechanical control panel**
- ▶ 3 extraction levels
- ▶ Extraction power: **335m³/h** - 166m³/h
- ▶ Motor maximum airflow free outlet: 360m³/h
- ▶ Sound power: **51dB(A)**, maximum: 66dB(A)
- ▶ 1 motor. Extra silent.
- ▶ Maximum energy consumption **65W**
- ▶ High efficiency Compact STRIP LED lighting
- ▶ Energy Class: B

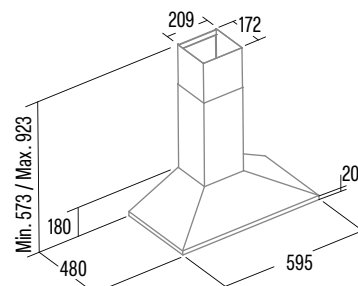
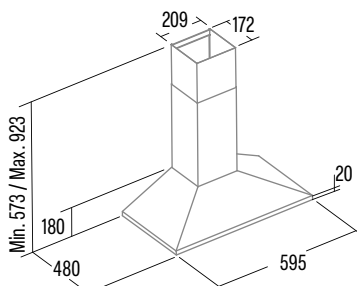
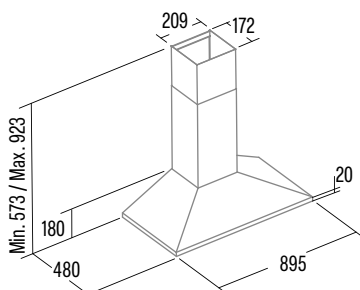

Q-7790 BK

Cod.: 02149402 EAN: 8422248084161



- ▶ **Mechanical control panel**
- ▶ 3 extraction levels
- ▶ Extraction power: **645m³/h** - 385m³/h
- ▶ Motor maximum airflow free outlet: 1150m³/h
- ▶ Sound power: **58dB(A)**, maximum: 72dB(A)
- ▶ M3R motor. Extra silent.
- ▶ Maximum energy consumption **270W**
- ▶ High efficiency LED lighting
- ▶ Energy Class: C

Q-7760 BK

Cod.: 02148402 EAN: 8422248084178



- ▶ **Mechanical control panel**
- ▶ 3 extraction levels
- ▶ Extraction power: **645m³/h** - 385m³/h
- ▶ Motor maximum airflow free outlet: 1150m³/h
- ▶ Sound power: **58dB(A)**, maximum: 72dB(A)
- ▶ M3R motor. Extra silent.
- ▶ Maximum energy consumption **270W**
- ▶ High efficiency LED lighting
- ▶ Energy Class: C

CHORUS XBK

Cod.: 02165201 EAN: 8422248055529



- ▶ **HOOD: Mechanical Control Panel**
- ▶ 3 extraction levels
- ▶ Extraction power: **400m³/h** - 210m³/h
- ▶ Motor maximum airflow free outlet: 600m³/h
- ▶ Sound power: **50dB(A)**, maximum: 62dB(A)
- ▶ Motor K7 PLUS. Extra silent. Maximum energy consumption **95W**
- ▶ High efficiency LED lighting
- ▶ Energy Class: C
- ▶ **MICROWAVE FEATURES:** 20 litre microwave
- ▶ Simultaneous 1,000 W quartz grill, 5 power levels, 700 W output
- ▶ Revolving dish ø255 mm
- ▶ Timer from 0 to 95 minutes
- ▶ Automatic defrosting by time and weight
- ▶ 9 automatic access menus
- ▶ Fast start button
- ▶ Safety lock

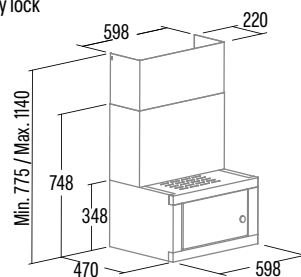
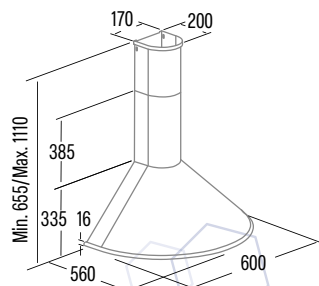
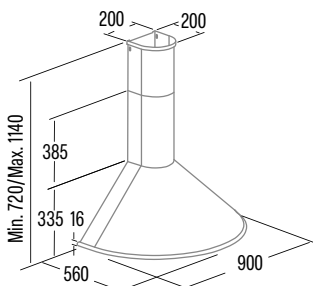

BUILT-IN HOODS

TENTA 90 GWH

Cod.: **02189005** EAN: **8422248093729**

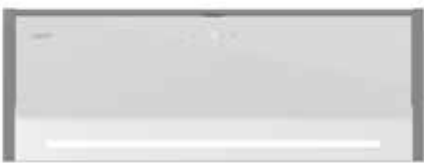

- ▶ **Touch Control Panel** with digital display, automatic shut-down timer and cleaning filters indicator
- ▶ 6 extraction levels, 5 + 1 **TURBO**
- ▶ Extraction power: **765m³/h** - 245m³/h
- ▶ Motor maximum airflow free outlet: 1400m³/h
- ▶ Sound power: **46dB(A)**, maximum: 63dB(A)
- ▶ BRUSHLESS motor. Ultra silent. Maximum energy consumption **135W**
- ▶ **AUTO 2 connectivity for control of the CATA AUTO 2 hobs**
- ▶ High-efficiency lighting by intensity-adjustable two-tone warm / natural STRIP LED
- ▶ **Energy Class: A+**

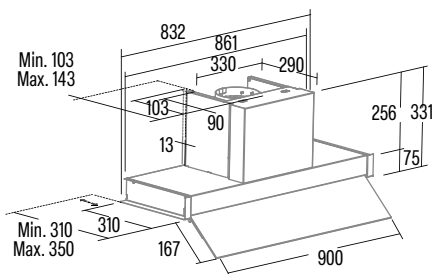

cata & Can Rocca

CORONA X NO DRIP 120

Cod.: **02181310** EAN: **8422248370783**



- ▶ **Electronic Control Panel** with digital display, automatic shut-down timer and cleaning filters indicator
- ▶ 4 extraction levels, 3 + 1 **TURBO**
- ▶ Extraction power: **766m³/h** - 272m³/h
- ▶ Sound power: **54dB(A)**, maximum: 69dB(A)
- ▶ BT5 AC 800 motor. Ultra silent. Maximum energy consumption **280W**
- ▶ **AUTO 2 connectivity for control of the CATA AUTO 2 hobs**
- ▶ **Air purification function**
- ▶ **Non-condensation filter and filter condensation collection zone**
- ▶ High efficiency strip Led lighting, adjustable intensity
- ▶ **Energy Class: A**

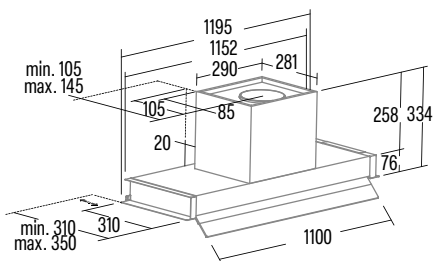

cata & Can Rocca

CORONA X NO DRIP 90

Cod.: **02189310** EAN: **8422248370776**



- ▶ **Electronic Control Panel** with digital display, automatic shut-down timer and cleaning filters indicator
- ▶ 4 extraction levels, 3 + 1 **TURBO**
- ▶ Extraction power: **766m³/h** - 272m³/h
- ▶ Sound power: **54dB(A)**, maximum: 69dB(A)
- ▶ BT5 AC 800 motor. Ultra silent. Maximum energy consumption **280W**
- ▶ **AUTO 2 connectivity for control of the CATA AUTO 2 hobs**
- ▶ **Air purification function**
- ▶ **Non-condensation filter and filter condensation collection zone**
- ▶ High efficiency strip Led lighting, adjustable intensity
- ▶ **Energy Class: A**

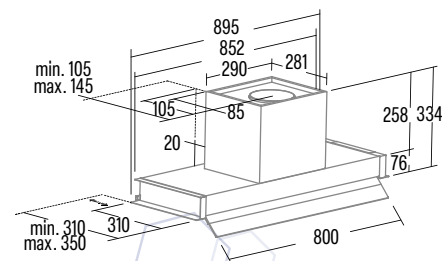

cata & Can Rocca

CORONA X NO DRIP 80

Cod.: **02188310** EAN: **8422248370769**



- ▶ **Electronic Control Panel** with digital display, automatic shut-down timer and cleaning filters indicator
- ▶ 4 extraction levels, 3 + 1 **TURBO**
- ▶ Extraction power: **766m³/h** - 272m³/h
- ▶ Sound power: **54dB(A)**, maximum: 69dB(A)
- ▶ BT5 AC 800 motor. Ultra silent. Maximum energy consumption **280W**
- ▶ **AUTO 2 connectivity for control of the CATA AUTO 2 hobs**
- ▶ **Air purification function**
- ▶ **Non-condensation filter and filter condensation collection zone**
- ▶ High efficiency strip Led lighting, adjustable intensity
- ▶ **Energy Class: A**

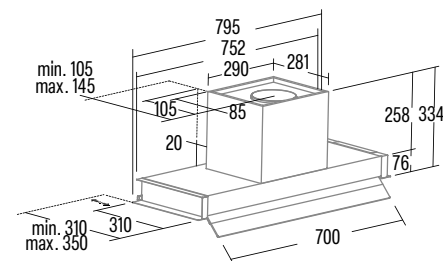

CORONA X NO DRIP 60

Cod.: 02186310 EAN: 8422248370752



NEW

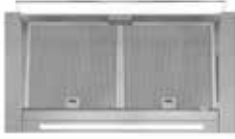

- ▶ **Electronic Control Panel** with digital display, automatic shut-down timer and cleaning filters indicator
- ▶ 4 extraction levels, 3 + 1 **TURBO**
- ▶ Extraction power: **766m³/h** - 272m³/h
- ▶ Sound power: **54dB(A)**, maximum: 69dB(A)
- ▶ BT5 AC 800 motor. Ultra silent.
- ▶ Maximum energy consumption **280W**
- ▶ **AUTO 2 connectivity for control of the CATA AUTO 2 hobs**
- ▶ **Air purification function**
- ▶ **Non-condensation filter and filter condensation collection zone**
- ▶ High efficiency strip Led lighting, adjustable intensity
- ▶ **Energy Class: A**

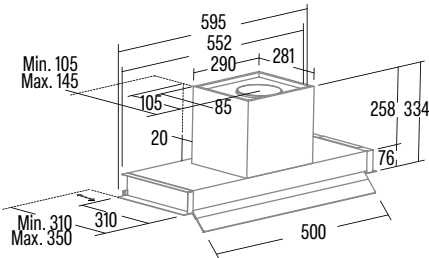

CORONA X 120

Cod.: 02181308 EAN: 8422248110556



- ▶ **Electronic Control Panel** with automatic shut-down timer
- ▶ 4 extraction levels, 3 + 1 **TURBO**
- ▶ Extraction power: **850m³/h** - 340m³/h
- ▶ Motor maximum airflow free outlet: 1350m³/h
- ▶ Sound power: **50dB(A)**, maximum: 65dB(A)
- ▶ BT3 motor. Ultra silent.
- ▶ Maximum energy consumption **280W**
- ▶ High efficiency strip Led lighting, adjustable intensity
- ▶ **Energy Class: A**

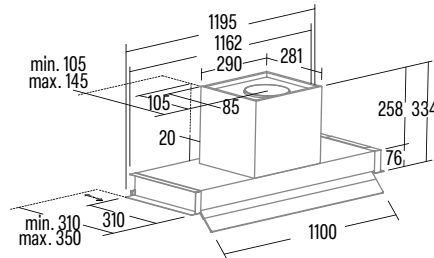

CORONA X 100

Cod.: 02180308 EAN: 8422248198547



- ▶ **Electronic Control Panel** with automatic shut-down timer
- ▶ 4 extraction levels, 3 + 1 **TURBO**
- ▶ Extraction power: **850m³/h** - 340m³/h
- ▶ Motor maximum airflow free outlet: 1350m³/h
- ▶ Sound power: **50dB(A)**, maximum: 65dB(A)
- ▶ BT3 motor. Ultra silent.
- ▶ Maximum energy consumption **280W**
- ▶ High efficiency strip Led lighting, adjustable intensity
- ▶ **Energy Class: A**

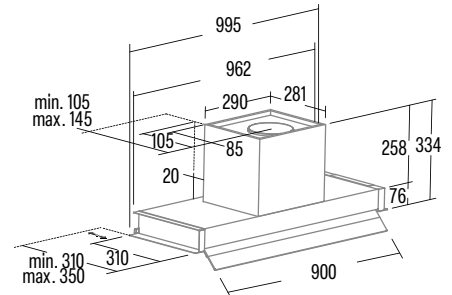

CORONA X 90

Cod.: 02189308 EAN: 8422248110549



- ▶ **Electronic Control Panel** with automatic shut-down timer
- ▶ 4 extraction levels, 3 + 1 **TURBO**
- ▶ Extraction power: **850m³/h** - 340m³/h
- ▶ Motor maximum airflow free outlet: 1350m³/h
- ▶ Sound power: **50dB(A)**, maximum: 65dB(A)
- ▶ BT3 motor. Ultra silent.
- ▶ Maximum energy consumption **280W**
- ▶ High efficiency strip Led lighting, adjustable intensity
- ▶ **Energy Class: A**

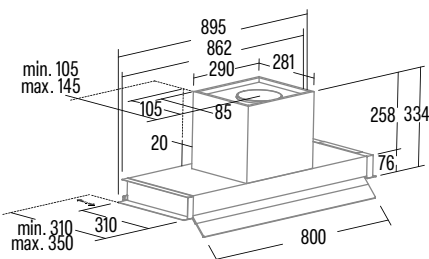

CORONA X 80

Cod.: 02188308 EAN: 8422248110532



- ▶ **Electronic Control Panel** with automatic shut-down timer
- ▶ 4 extraction levels, 3 + 1 **TURBO**
- ▶ Extraction power: **850m³/h** - 340m³/h
- ▶ Motor maximum airflow free outlet: 1350m³/h
- ▶ Sound power: **50dB(A)**, maximum: 65dB(A)
- ▶ BT3 motor. Ultra silent.
- ▶ Maximum energy consumption **280W**
- ▶ High efficiency strip Led lighting, adjustable intensity
- ▶ **Energy Class: A**

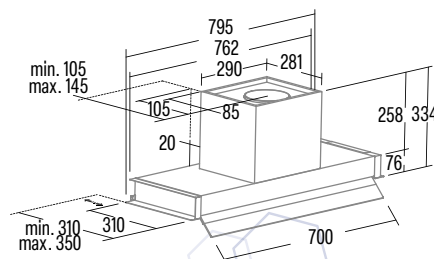

CORONA X 70

Cod.: 02187308 EAN: 8422248110525



- ▶ **Electronic Control Panel** with automatic shut-down timer
- ▶ 4 extraction levels, 3 + 1 **TURBO**
- ▶ Extraction power: **850m³/h** - 340m³/h
- ▶ Motor maximum airflow free outlet: 1350m³/h
- ▶ Sound power: **50dB(A)**, maximum: 65dB(A)
- ▶ BT3 motor. Ultra silent.
- ▶ Maximum energy consumption **280W**
- ▶ High efficiency strip Led lighting, adjustable intensity
- ▶ **Energy Class: A**

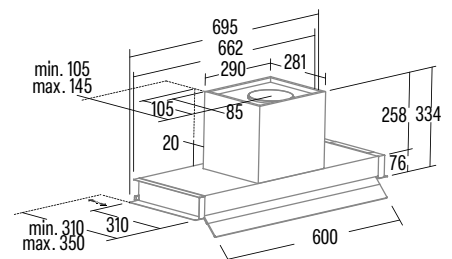

BUILT-IN HOODS

CORONA X 60

Cod.: **02186308** EAN: **8422248110518**



- ▶ **Electronic Control Panel** with automatic shut-down timer
- ▶ 4 extraction levels, **3 + 1 TURBO**
- ▶ Extraction power: **850m³/h** - 340m³/h
- ▶ Motor maximum airflow free outlet: 1350m³/h
- ▶ Sound power: **50dB(A)**, maximum: 65dB(A)
- ▶ BT3 motor. Ultra silent.
- ▶ Maximum energy consumption **280W**
- ▶ High efficiency strip Led lighting, adjustable intensity
- ▶ **Energy Class: A**

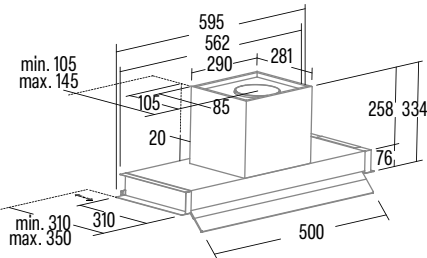

CORONA BK 90

Cod.: **02189400** EAN: **8422248348782**

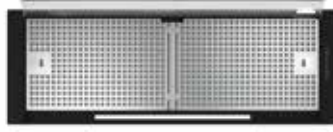

- ▶ **Electronic Control Panel** with automatic shut-down timer
- ▶ 4 extraction levels, **3 + 1 TURBO**
- ▶ Extraction power: **850m³/h** - 340m³/h
- ▶ Motor maximum airflow free outlet: 1350m³/h
- ▶ Sound power: **50dB(A)**, maximum: 65dB(A)
- ▶ BT3 motor. Ultra silent.
- ▶ Maximum energy consumption **280W**
- ▶ High efficiency strip Led lighting, adjustable intensity
- ▶ **Energy Class: A**

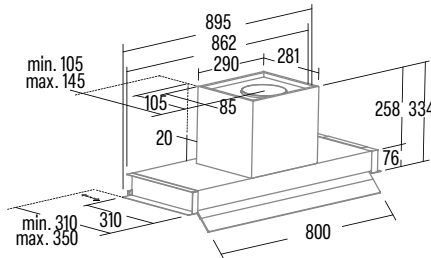

CORONA BK 60

Cod.: **02186400** EAN: **8422248198257**



- ▶ **Electronic Control Panel** with automatic shut-down timer
- ▶ 4 extraction levels, **3 + 1 TURBO**
- ▶ Extraction power: **850m³/h** - 340m³/h
- ▶ Motor maximum airflow free outlet: 1350m³/h
- ▶ Sound power: **50dB(A)**, maximum: 65dB(A)
- ▶ BT3 motor. Ultra silent.
- ▶ Maximum energy consumption **280W**
- ▶ High efficiency strip Led lighting, adjustable intensity
- ▶ **Energy Class: A**

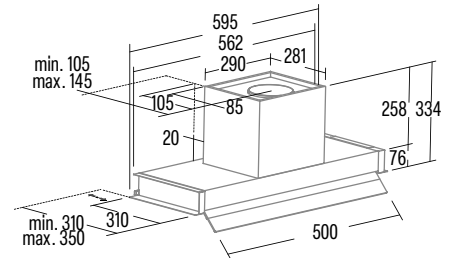

CORONA WH 60

Cod.: **02186010** EAN: **8422248355216**



- ▶ **Electronic Control Panel** with automatic shut-down timer
- ▶ 4 extraction levels, **3 + 1 TURBO**
- ▶ Extraction power: **850m³/h** - 340m³/h
- ▶ Motor maximum airflow free outlet: 1350m³/h
- ▶ Sound power: **50dB(A)**, maximum: 65dB(A)
- ▶ BT3 motor. Ultra silent.
- ▶ Maximum energy consumption **280W**
- ▶ High efficiency strip Led lighting, adjustable intensity
- ▶ **Energy Class: A**

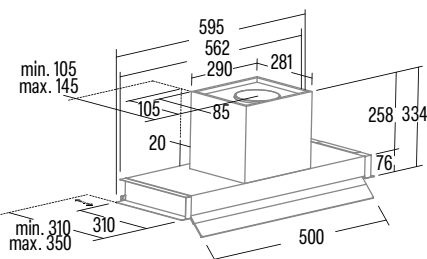

ARONA 90 X

Cod.: **02189311** EAN: **8422248372121**



- ▶ **Electronic Control Panel** with digital display, automatic shut-down timer and cleaning filters indicator
- ▶ 6 extraction levels, **5 + 1 TURBO**
- ▶ Extraction power: **766m³/h** - 272m³/h
- ▶ Sound power: **54dB(A)**, maximum: 69dB(A)
- ▶ BT5 AC 800 motor. Ultra silent.
- ▶ Maximum energy consumption **280W**
- ▶ **AUTO 2 connectivity for control of the CATA AUTO 2 hobs**
- ▶ **Air purification function**
- ▶ Bicolor LED strip lighting with adjustable intensity
- ▶ **Energy Class: A**

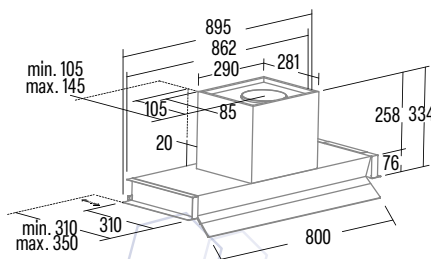

ARONA 60 X

Cod.: **02186311** EAN: **8422248372152**



- ▶ **Electronic Control Panel** with digital display, automatic shut-down timer and cleaning filters indicator
- ▶ 6 extraction levels, **5 + 1 TURBO**
- ▶ Extraction power: **766m³/h** - 272m³/h
- ▶ Sound power: **54dB(A)**, maximum: 69dB(A)
- ▶ BT5 AC 800 motor. Ultra silent.
- ▶ Maximum energy consumption **280W**
- ▶ **AUTO 2 connectivity for control of the CATA AUTO 2 hobs**
- ▶ **Air purification function**
- ▶ Bicolor LED strip lighting with adjustable intensity
- ▶ **Energy Class: A**

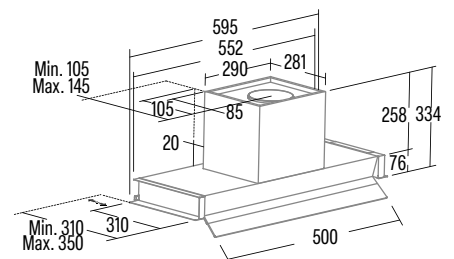

ARONA 90 BK

Cod.: 02189411 EAN: 8422248372138



- ▶ **Electronic Control Panel** with digital display, automatic shut-down timer and cleaning filters indicator
- ▶ 6 extraction levels, 5 + **1 TURBO**
- ▶ Extraction power: **766m³/h** - 272m³/h
- ▶ Sound power: **54dB(A)**, maximum: 69dB(A)
- ▶ BT5 AC 800 motor. Ultra silent.
- ▶ Maximum energy consumption **280W**
- ▶ **AUTO 2 connectivity for control of the CATA AUTO 2 hobs**
- ▶ **Air purification function**
- ▶ Bicolor LED strip lighting with adjustable intensity
- ▶ **Energy Class: A**

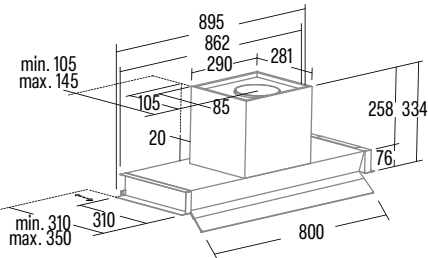

ARONA 60 BK

Cod.: 02186411 EAN: 8422248372145



- ▶ **Electronic Control Panel** with digital display, automatic shut-down timer and cleaning filters indicator
- ▶ 6 extraction levels, 5 + **1 TURBO**
- ▶ Extraction power: **766m³/h** - 272m³/h
- ▶ Sound power: **54dB(A)**, maximum: 69dB(A)
- ▶ BT5 AC 800 motor. Ultra silent.
- ▶ Maximum energy consumption **280W**
- ▶ **AUTO 2 connectivity for control of the CATA AUTO 2 hobs**
- ▶ **Air purification function**
- ▶ Bicolor LED strip lighting with adjustable intensity
- ▶ **Energy Class: A**

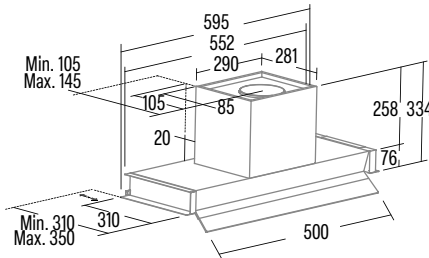

ARMONIA 90 X

Cod.: 02189309 EAN: 8422248110587



- ▶ **Mechanical Control Panel**
- ▶ 3 extraction levels
- ▶ Extraction power: **645m³/h** - 385m³/h
- ▶ Motor maximum airflow free outlet: 1150m³/h
- ▶ Sound power: **56dB(A)**, maximum: 70dB(A)
- ▶ B3R motor. Extra silent.
- ▶ Maximum energy consumption **270W**
- ▶ High efficiency compact STRIP LED lighting
- ▶ Energy Class: C

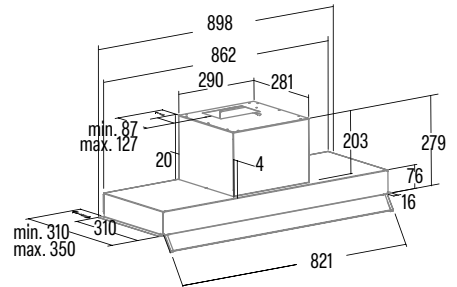

ARMONIA 80 X

Cod.: 02188309 EAN: 8422248356022



- ▶ **Mechanical Control Panel**
- ▶ 3 extraction levels
- ▶ Extraction power: **645m³/h** - 385m³/h
- ▶ Motor maximum airflow free outlet: 1150m³/h
- ▶ Sound power: **56dB(A)**, maximum: 70dB(A)
- ▶ B3R motor. Extra silent.
- ▶ Maximum energy consumption **270W**
- ▶ High efficiency compact STRIP LED lighting
- ▶ Energy Class: C

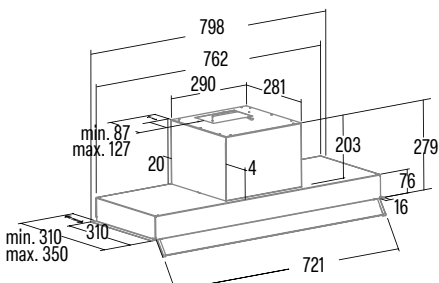

ARMONIA 70 X

Cod.: 02187309 EAN: 8422248351928



- ▶ **Mechanical Control Panel**
- ▶ 3 extraction levels
- ▶ Extraction power: **645m³/h** - 385m³/h
- ▶ Motor maximum airflow free outlet: 1150m³/h
- ▶ Sound power: **56dB(A)**, maximum: 70dB(A)
- ▶ B3R motor. Extra silent.
- ▶ Maximum energy consumption **270W**
- ▶ High efficiency compact STRIP LED lighting
- ▶ Energy Class: C

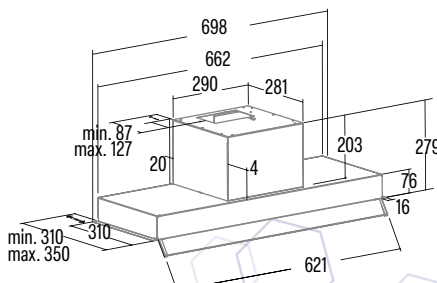

ARMONIA 60 X

Cod.: 02186309 EAN: 8422248110570



- ▶ **Mechanical Control Panel**
- ▶ 3 extraction levels
- ▶ Extraction power: **645m³/h** - 385m³/h
- ▶ Motor maximum airflow free outlet: 1150m³/h
- ▶ Sound power: **56dB(A)**, maximum: 70dB(A)
- ▶ B3R motor. Extra silent.
- ▶ Maximum energy consumption **270W**
- ▶ High efficiency compact STRIP LED lighting
- ▶ Energy Class: C

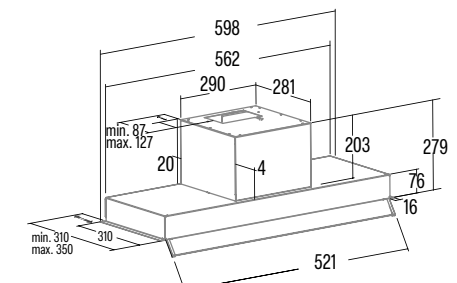

BUILT-IN HOODS

ARMONIA 45 X

Cod.: **02184309** EAN: **8422248110563**



► **Mechanical Control Panel**

- 3 extraction levels
- Extraction power: **645m³/h** - 385m³/h
- Motor maximum airflow free outlet: 1150m³/h
- Sound power: **56dB(A)**, maximum: 70dB(A)
- B3R motor. Extra silent.
- Maximum energy consumption **270W**
- High efficiency compact STRIP LED lighting
- Energy Class: C

ARMONIA 70 BK

Cod.: **02187409** EAN: **8422248356015**



► **Mechanical Control Panel**

- 3 extraction levels
- Extraction power: **645m³/h** - 385m³/h
- Motor maximum airflow free outlet: 1150m³/h
- Sound power: **56dB(A)**, maximum: 70dB(A)
- B3R motor. Extra silent.
- Maximum energy consumption **270W**
- High efficiency compact STRIP LED lighting
- Energy Class: C

ARMONIA 60 BK

Cod.: **02186409** EAN: **8422248355995**



► **Mechanical Control Panel**

- 3 extraction levels
- Extraction power: **645m³/h** - 385m³/h
- Motor maximum airflow free outlet: 1150m³/h
- Sound power: **56dB(A)**, maximum: 70dB(A)
- B3R motor. Extra silent.
- Maximum energy consumption **270W**
- High efficiency compact STRIP LED lighting
- Energy Class: C

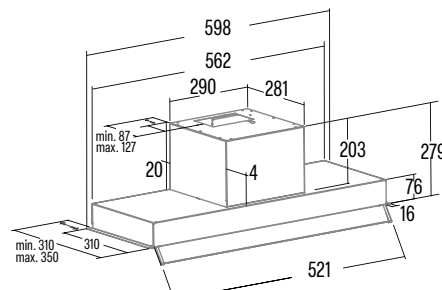
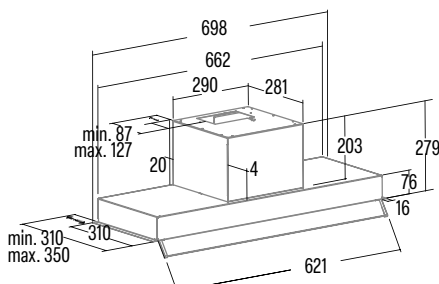
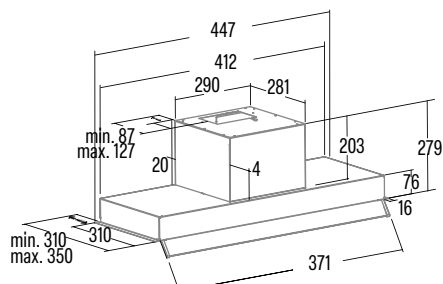

INSERTS

GC DUAL 75 BK

Cod.: **02131208** EAN: **8422248078320**



- **Touch control panel** with automatic shut-down timer and cleaning filters indicator + remote control
- 5 extraction levels, 4 + **1 TURBO**
- Extraction power: **820m³/h** - 340m³/h
- Motor maximum airflow free outlet: 1350m³/h
- Sound power: **50dB(A)**, maximum: 65dB(A)
- BT3 motor. Extra silent.
- Maximum energy consumption **280W**
- High efficiency LED lighting, adjustable intensity
- **Energy Class: A**

GC DUAL 45 BK

Cod.: **02130208** EAN: **8422248078306**



- **Touch control panel** with automatic shut-down timer and cleaning filters indicator + remote control
- 5 extraction levels, 4 + **1 TURBO**
- Extraction power: **820m³/h** - 340m³/h
- Motor maximum airflow free outlet: 1350m³/h
- Sound power: **50dB(A)**, maximum: 65dB(A)
- BT3 motor. Extra silent.
- Maximum energy consumption **280W**
- High efficiency LED lighting, adjustable intensity
- **Energy Class: A**

GC DUAL 75 WH

Cod.: **02131207** EAN: **8422248078313**



- **Touch control panel** with automatic shut-down timer and cleaning filters indicator + remote control
- 5 extraction levels, 4 + **1 TURBO**
- Extraction power: **820m³/h** - 340m³/h
- Motor maximum airflow free outlet: 1350m³/h
- Sound power: **50dB(A)**, maximum: 65dB(A)
- BT3 motor. Extra silent.
- Maximum energy consumption **280W**
- High efficiency LED lighting, adjustable intensity
- **Energy Class: A**

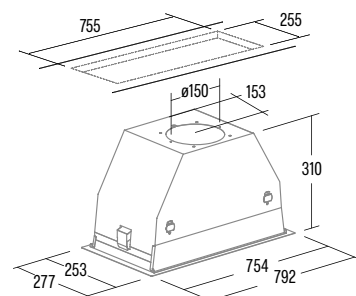
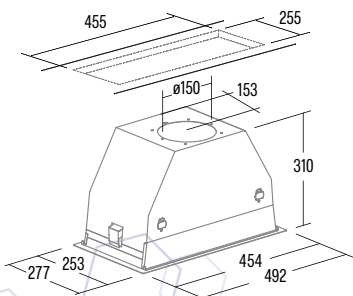
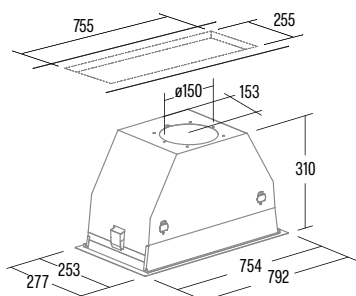

GC DUAL 45 WH

 Cod.: **02130207** EAN: **8422248078290**

- ▶ **Touch control panel** with automatic shut-down timer and cleaning filters indicator + remote control
- ▶ 5 extraction levels, 4 + **1 TURBO**
- ▶ Extraction power: **820m³/h** - 340m³/h
- ▶ Motor maximum airflow free outlet: 1350m³/h
- ▶ Sound power: **50dB(A)**, maximum: 65dB(A)
- ▶ BT3 motor. Extra silent.
- Maximum energy consumption **280W**
- ▶ High efficiency LED lighting, adjustable intensity
- ▶ **Energy Class: A**

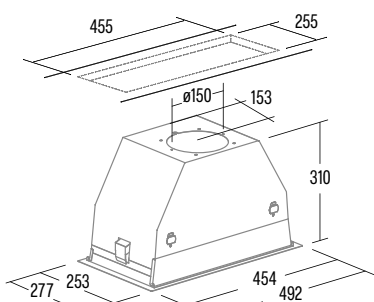
GCX 83 SD

 Cod.: **02031308** EAN: **8422248103589**

- ▶ **Touch Control Panel** with automatic shut-down timer and cleaning filters indicator
- ▶ 4 extraction levels, 3 + **1 TURBO**
- ▶ Extraction power: **750m³/h** - 340m³/h
- ▶ Motor maximum airflow free outlet: 1350m³/h
- ▶ Sound power: **50dB(A)**, maximum: 65dB(A)
- ▶ BT3 motor. Extra silent.
- Maximum energy consumption **280W**
- ▶ High efficiency STRIP LED lighting
- ▶ **Energy Class: A**

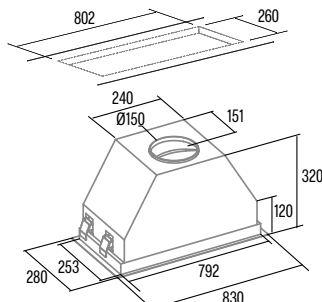
GCX 53 SD

 Cod.: **02030308** EAN: **8422248103572**

- ▶ **Touch Control Panel** with automatic shut-down timer and cleaning filters indicator
- ▶ 4 extraction levels, 3 + **1 TURBO**
- ▶ Extraction power: **750m³/h** - 340m³/h
- ▶ Motor maximum airflow free outlet: 1350m³/h
- ▶ Sound power: **50dB(A)**, maximum: 65dB(A)
- ▶ BT3 motor. Extra silent.
- Maximum energy consumption **280W**
- ▶ High efficiency STRIP LED lighting
- ▶ **Energy Class: A**

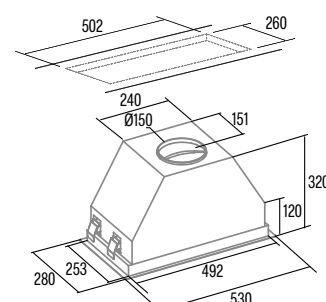

GL 75 X

Cod.: **02031302** EAN: **8422248190411**



- ▶ **Touch Control Panel** with automatic shut-down timer and cleaning filters indicator
- ▶ 4 extraction levels, 3 + 1 **TURBO**
- ▶ Extraction power: **850m³/h** - 340m³/h
- ▶ Motor maximum airflow free outlet: 1350m³/h
- ▶ Sound power: **50dB(A)**, maximum: 65dB(A)
- ▶ BT3 motor. Extra silent.
- Maximum energy consumption **280W**
- ▶ High efficiency Led lighting, adjustable intensity
- ▶ **Energy Class: A**

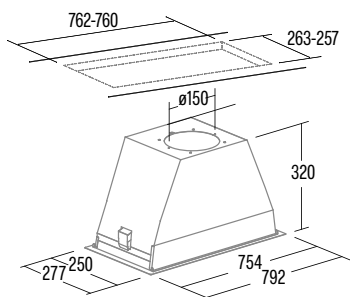

GL 45 X

Cod.: **02030305** EAN: **8422248077842**



- ▶ **Touch Control Panel** with automatic shut-down timer and cleaning filters indicator
- ▶ 4 extraction levels, 3 + 1 **TURBO**
- ▶ Extraction power: **850m³/h** - 340m³/h
- ▶ Motor maximum airflow free outlet: 1350m³/h
- ▶ Sound power: **50dB(A)**, maximum: 65dB(A)
- ▶ BT3 motor. Extra silent.
- Maximum energy consumption **280W**
- ▶ High efficiency Led lighting, adjustable intensity
- ▶ **Energy Class: A**

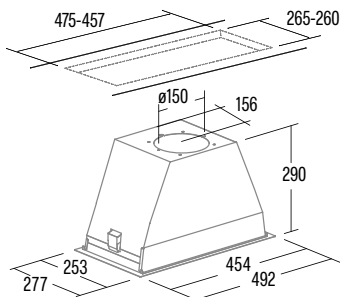

GT-PLUS 75 X

Cod.: **02031301** EAN: **8422248190381**



- ▶ **Mechanical Control Panel**
- ▶ 3 extractor levels
- ▶ Extraction power: **645 m³/h** - 300 m³/h
- ▶ Motor maximum airflow free outlet: 1200m³/h
- ▶ Sound power: **50dB(A)**, maximum: 65dB (A)
- ▶ BT2 motor. Extra silent.
- Maximum energy consumption **200W**
- ▶ High efficiency compact STRIP LED lighting
- ▶ Energy Class: C

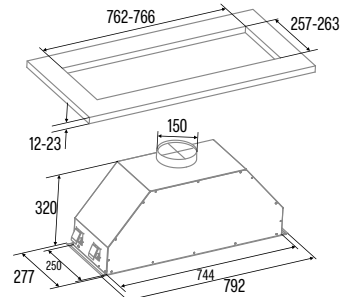

GT-PLUS 45 X

Cod.: **02030309** EAN: **8422248190374**



- ▶ **Mechanical Control Panel**
- ▶ 3 extractor levels
- ▶ Extraction power: **645 m³/h** - 300 m³/h
- ▶ Motor maximum airflow free outlet: 1200m³/h
- ▶ Sound power: **50dB(A)**, maximum: 65dB (A)
- ▶ BT2 motor. Extra silent.
- Maximum energy consumption **200W**
- ▶ High efficiency compact STRIP LED lighting
- ▶ Energy Class: C

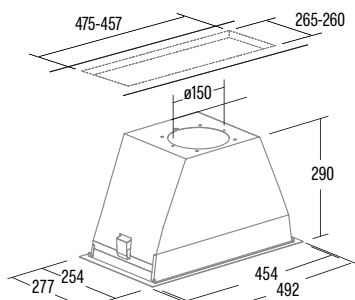

GT-PLUS 45 WH

Cod.: **02030005** EAN: **8422248190398**



- ▶ **Mechanical Control Panel**
- ▶ 3 extractor levels
- ▶ Extraction power: **645 m³/h** - 300 m³/h
- ▶ Motor maximum airflow free outlet: 1200m³/h
- ▶ Sound power: **50dB(A)**, maximum: 65dB (A)
- ▶ BT2 motor. Extra silent.
- Maximum energy consumption **200W**
- ▶ High efficiency compact STRIP LED lighting
- ▶ Energy Class: C

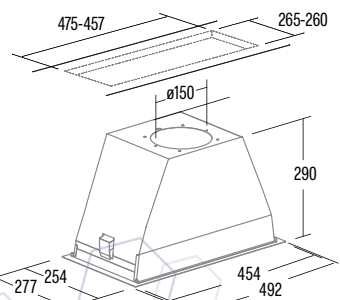

GT-PLUS 45 BK

Cod.: **02030408** EAN: **8422248190404**



- ▶ **Mechanical Control Panel**
- ▶ 3 extractor levels
- ▶ Extraction power: **645 m³/h** - 300 m³/h
- ▶ Motor maximum airflow free outlet: 1200m³/h
- ▶ Sound power: **50dB(A)**, maximum: 65dB (A)
- ▶ BT2 motor. Extra silent.
- Maximum energy consumption **200W**
- ▶ High efficiency compact STRIP LED lighting
- ▶ Energy Class: C

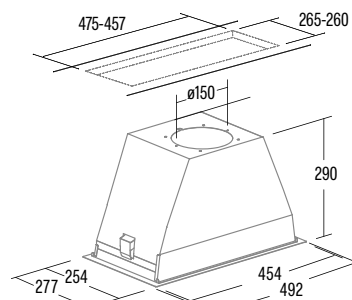

GCB 73 X

Cod.: 02031300 EAN: 8422248108461



► **Mechanical Control Panel**

- 3 extraction levels
- Extraction power: **372m³/h** -283m³/h
- Motor maximum airflow free outlet: 620m³/h
- Sound power: **60dB(A)**, maximum: 66dB(A)
- 1 motor. Extra silent.
- Maximum energy consumption **120W**
- High efficiency compact STRIP LED lighting
- Energy Class: C

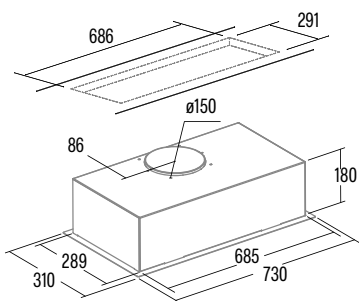

GCB 55 X

Cod.: 02030300 EAN: 8422248108454

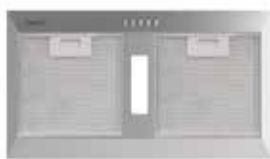

► **Mechanical Control Panel**

- 3 extraction levels
- Extraction power: **372m³/h** -283m³/h
- Motor maximum airflow free outlet: 620m³/h
- Sound power: **59dB(A)**, maximum: 66dB(A)
- 1 motor. Extra silent.
- Maximum energy consumption **120W**
- High efficiency compact STRIP LED lighting
- Energy Class: C

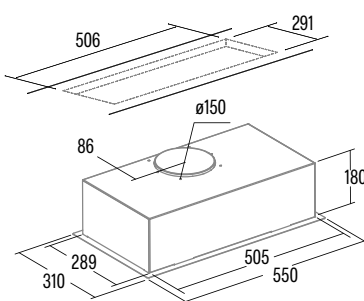

G 50 LUX X

Cod.: 02130302 EAN: 8422248082716



► **Mechanical Control Panel**

- 3 extraction levels
- Extraction power: **400m³/h** -210m³/h
- Motor maximum airflow free outlet: 620m³/h
- Sound power: **50dB(A)**, maximum: 62dB(A)
- K7 PLUS motor.
- Extra silent. Maximum energy consumption **95W**
- High efficiency Led lighting
- Energy Class: C

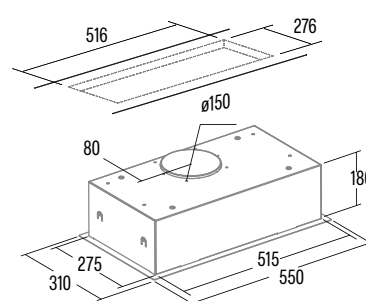

GK 4500 X

Cod.: 02039306 EAN: 8422248357135



NEW

► **Slider Control Panel**

- 2 extraction levels
- Extraction power: **360m³/h** - 190m³/h
- Motor maximum airflow free outlet: 620m³/h
- Sound power: **56dB(A)**, maximum: 67dB(A)
- Tangential motor. Extra silent. Maximum energy consumption **103W**
- Iluminación LED E-14 (EU Models)
- Energy Class: B (EU Models)

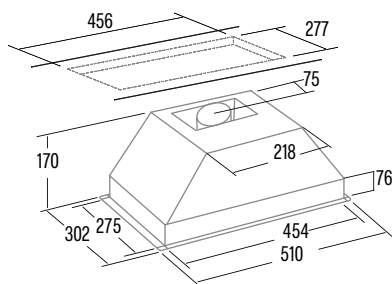

GK 4500 X+FCA

Cod.: 02039308 EAN: 8422248371278



NEW

► **Slider Control Panel**

- 2 extraction levels
- Extraction power: **360m³/h** - 190m³/h
- Sound power: **56dB(A)**, maximum: 67dB(A)
- K11 motor. Maximum energy consumption **90W**
- E-14 LED lighting
- **Carbon filter included**
- Energy Class: B (EU Models)

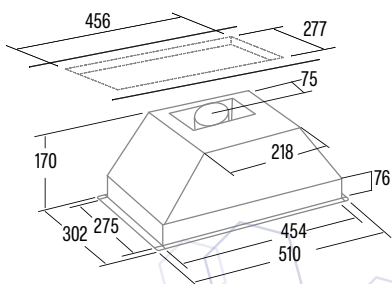

GK 4500 WH

Cod.: 02039007 EAN: 8422248357142



NEW

► **Slider Control Panel**

- 2 extraction levels
- Extraction power: **360m³/h** - 190m³/h
- Motor maximum airflow free outlet: 620m³/h
- Sound power: **56dB(A)**, maximum: 67dB(A)
- K11 motor. Maximum energy consumption **90W**
- E-14 LED lighting
- Energy Class: B (EU Models)

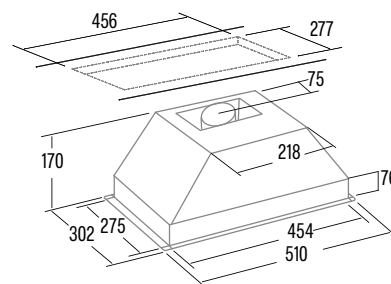

TELESCOPIC

TFH 9830 X

Cod.: 02094307 EAN: 8422248371285



- ▶ **Touch Control Panel** with digital display, automatic shut-down timer and cleaning filters indicator
- ▶ 6 extraction levels, 5 + 1 **TURBO**
- ▶ Extraction power: **795m³/h** - 201m³/h
- ▶ Sound power: **46dB(A)**, maximum: 64dB(A)
- ▶ BRUSHLESS motor. Ultra silent. Maximum energy consumption **135W**
- ▶ High efficiency Strip Led lighting adjustable intensity
- ▶ **Energy Class: A+**

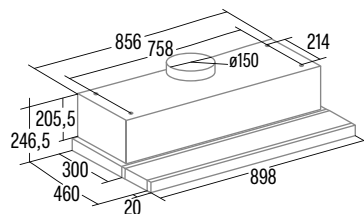

TFH 7430 GBK

Cod.: 02089307 EAN: 8422248371292



- ▶ **Touch Control Panel** with digital display, automatic shut-down timer and cleaning filters indicator
- ▶ 6 extraction levels, 5 + 1 **TURBO**
- ▶ Extraction power: **391m³/h** - 164m³/h
- ▶ Sound power: **44dB(A)**, maximum: 62dB(A)
- ▶ BRUSHLESS motor. Ultra silent. Maximum energy consumption **55W**
- ▶ High efficiency Strip Led lighting adjustable intensity
- ▶ **Energy Class: A+**

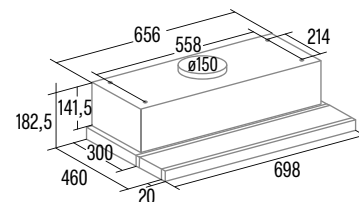

TFH-6830 X

Cod.: 02010601 EAN: 8422248112741



- ▶ **Touch Control Panel** with automatic shut-down timer and cleaning filters indicator
- ▶ 6 extraction levels, 5 + 1 **TURBO**
- ▶ Extraction power: **795m³/h** - 291m³/h
- ▶ Motor maximum airflow free outlet: 1200m³/h
- ▶ Sound power: **46dB(A)**, maximum: 64dB(A)
- ▶ BRUSHLESS motor. Extra silent. Maximum energy consumption **135W**
- ▶ High efficiency STRIP LED lighting, adjustable intensity
- ▶ **Energy Class: A+++**

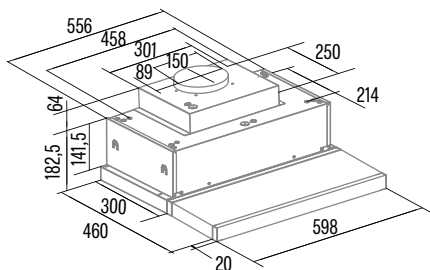

TFH-6830 GWH

Cod.: 02010101 EAN: 8422248112758



- ▶ **Touch Control Panel** with automatic shut-down timer and cleaning filters indicator
- ▶ 6 extraction levels, 5 + 1 **TURBO**
- ▶ Extraction power: **795m³/h** - 291m³/h
- ▶ Motor maximum airflow free outlet: 1200m³/h
- ▶ Sound power: **46dB(A)**, maximum: 64dB(A)
- ▶ BRUSHLESS motor. Extra silent. Maximum energy consumption **135W**
- ▶ High efficiency STRIP LED lighting, adjustable intensity
- ▶ **Energy Class: A+++**

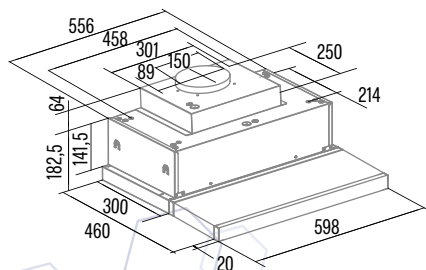

TFH-6830 GBK

Cod.: 02010404 EAN: 8422248357364



- ▶ **Touch Control Panel** with automatic shut-down timer and cleaning filters indicator
- ▶ 6 extraction levels, 5 + 1 **TURBO**
- ▶ Extraction power: **795m³/h** - 291m³/h
- ▶ Motor maximum airflow free outlet: 1200m³/h
- ▶ Sound power: **46dB(A)**, maximum: 64dB(A)
- ▶ BRUSHLESS motor. Extra silent. Maximum energy consumption **135W**
- ▶ High efficiency STRIP LED lighting, adjustable intensity
- ▶ **Energy Class: A+++**

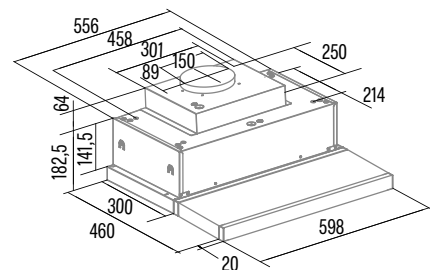

TFH 6630 X

Cod.: **02010300** EAN: **8422248082365**



- ▶ **Touch Control Panel** with digital display, automatic shut-down timer and cleaning filters indicator
- ▶ 6 extraction levels, 5 + **1 TURBO**
- ▶ Extraction power: **585m³/h** -210m³/h
- ▶ Motor maximum airflow free outlet: 1000m³/h
- ▶ Sound power: **47dB(A)**, maximum: 64dB(A)
- ▶ BRUSHLESS motor. Extra silent. Maximum energy consumption **90W**
- ▶ High efficiency STRIP LED lighting, adjustable intensity
- ▶ **Energy Class: A+**

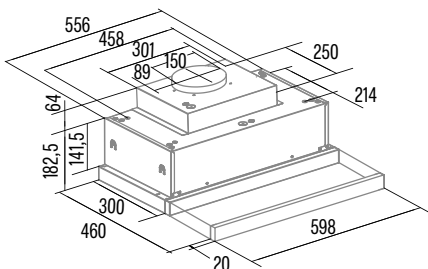

TFH 6630 BK

Cod.: **02010302** EAN: **8422248082402**



- ▶ **Touch Control Panel** with digital display, automatic shut-down timer and cleaning filters indicator
- ▶ 6 extraction levels, 5 + **1 TURBO**
- ▶ Extraction power: **585m³/h** -210m³/h
- ▶ Motor maximum airflow free outlet: 1000m³/h
- ▶ Sound power: **47dB(A)**, maximum: 64dB(A)
- ▶ BRUSHLESS motor. Extra silent. Maximum energy consumption **90W**
- ▶ High efficiency STRIP LED lighting, adjustable intensity
- ▶ **Energy Class: A+**

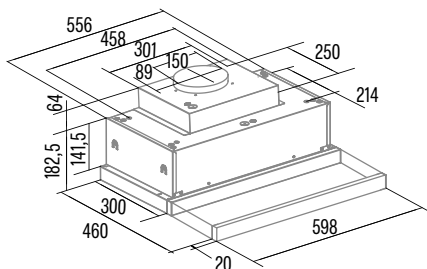

TFH 6630 WH

Cod.: **02010301** EAN: **8422248082396**



- ▶ **Touch Control Panel** with digital display, automatic shut-down timer and cleaning filters indicator
- ▶ 6 extraction levels, 5 + **1 TURBO**
- ▶ Extraction power: **585m³/h** -210m³/h
- ▶ Motor maximum airflow free outlet: 1000m³/h
- ▶ Sound power: **47dB(A)**, maximum: 64dB(A)
- ▶ BRUSHLESS motor. Extra silent. Maximum energy consumption **90W**
- ▶ High efficiency STRIP LED lighting, adjustable intensity
- ▶ **Energy Class: A+**

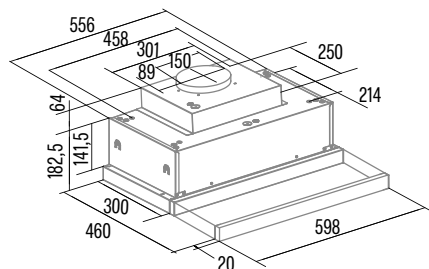

TFH 6430 X

Cod.: **02010609** EAN: **8422248343626**



- ▶ **Touch Control Panel** with digital display, automatic shut-down timer and cleaning filters indicator
- ▶ 4 extraction levels, 3 + **1 TURBO**
- ▶ Extraction power: **391m³/h** - 164m³/h
- ▶ Motor maximum airflow free outlet: 1000m³/h
- ▶ Sound power: **44dB(A)**, máximo: 62dB(A)
- ▶ BRUSHLESS motor. Extra silent. Maximum energy consumption **53W**
- ▶ High efficiency STRIP LED lighting adjustable intensity
- ▶ **Energy Class: A+**

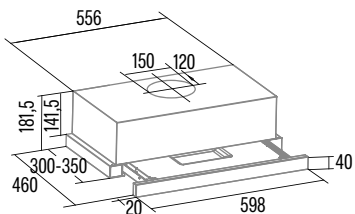

TFH 6430 GBK

Cod.: **02010409** EAN: **8422248343602**



- ▶ **Touch Control Panel** with digital display, automatic shut-down timer and cleaning filters indicator
- ▶ 4 extraction levels, 3 + **1 TURBO**
- ▶ Extraction power: **391m³/h** - 164m³/h
- ▶ Motor maximum airflow free outlet: 1000m³/h
- ▶ Sound power: **44dB(A)**, máximo: 62dB(A)
- ▶ BRUSHLESS motor. Extra silent. Maximum energy consumption **53W**
- ▶ High efficiency STRIP LED lighting adjustable intensity
- ▶ **Energy Class: A+**

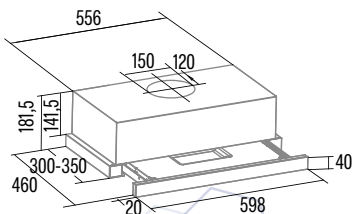

TFH 6430 GWH

Cod.: **02010009** EAN: **8422248343619**



- ▶ **Touch Control Panel** with digital display, automatic shut-down timer and cleaning filters indicator
- ▶ 4 extraction levels, 3 + **1 TURBO**
- ▶ Extraction power: **391m³/h** - 164m³/h
- ▶ Motor maximum airflow free outlet: 1000m³/h
- ▶ Sound power: **44dB(A)**, máximo: 62dB(A)
- ▶ BRUSHLESS motor. Extra silent. Maximum energy consumption **53W**
- ▶ High efficiency STRIP LED lighting adjustable intensity
- ▶ **Energy Class: A+**

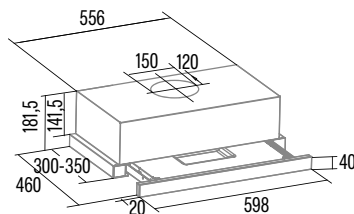

TF-2003 600 GBK

Cod.: 02017203 EAN: 8422248062015

TF-2003 600 GWH

Cod.: 02017202 EAN: 8422248062008



► **Mechanical control panel**

- 2 extraction levels
- Extraction power: **390m³/h** - 150m³/h
- Motor maximum airflow free outlet: 600m³/h
- Sound power: **45dB(A)**, maximum: 57dB(A)
- Tangential motor. Extra silent. Maximum energy consumption **100W**
- High efficiency LED lighting
- Energy Class: C

► **Mechanical control panel**

- 2 extraction levels
- Extraction power: **390m³/h** - 150m³/h
- Motor maximum airflow free outlet: 600m³/h
- Sound power: **45dB(A)**, maximum: 57dB(A)
- Tangential motor. Extra silent. Maximum energy consumption **100W**
- High efficiency LED lighting
- Energy Class: C

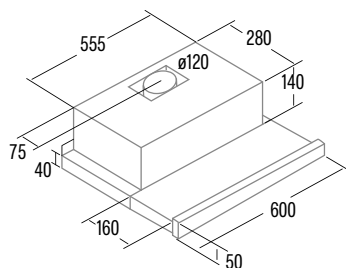
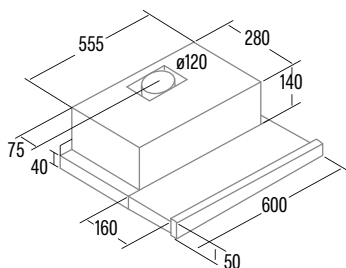

TF-2003 DURALUM 900

Cod.: **02094305** EAN: **8422248061964**



- ▶ **Mechanical control panel**
- ▶ 2 extraction levels
- ▶ Extraction power: **390m³/h** - 150m³/h
- ▶ Motor maximum airflow free outlet: 600m³/h
- ▶ Sound power: **45dB(A)**, maximum: 57dB(A)
- ▶ Tangential motor. Extra silent. Maximum energy consumption **100W**
- ▶ **Replaceable handrail**
- ▶ **Easy-to-clean inner panel**
- ▶ High efficiency LED lighting
- ▶ Energy Class: C

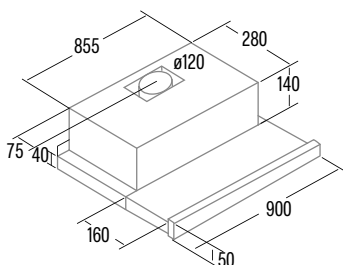

TF-2003 DURALUM 700

Cod.: **02089305** EAN: **8422248061971**



- ▶ **Mechanical control panel**
- ▶ 2 extraction levels
- ▶ Extraction power: **390m³/h** - 150m³/h
- ▶ Motor maximum airflow free outlet: 600m³/h
- ▶ Sound power: **45dB(A)**, maximum: 57dB(A)
- ▶ Tangential motor. Extra silent. Maximum energy consumption **100W**
- ▶ **Replaceable handrail**
- ▶ **Easy-to-clean inner panel**
- ▶ High efficiency LED lighting
- ▶ Energy Class: C

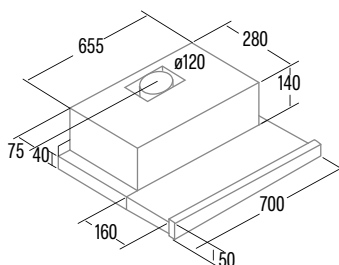

TF-2003 DURALUM 600

Cod.: **02017305** EAN: **8422248061988**



- ▶ **Mechanical control panel**
- ▶ 2 extraction levels
- ▶ Extraction power: **390m³/h** - 150m³/h
- ▶ Motor maximum airflow free outlet: 600m³/h
- ▶ Sound power: **45dB(A)**, maximum: 57dB(A)
- ▶ Tangential motor. Extra silent. Maximum energy consumption **100W**
- ▶ **Replaceable handrail**
- ▶ **Easy-to-clean inner panel**
- ▶ High efficiency LED lighting
- ▶ Energy Class: C

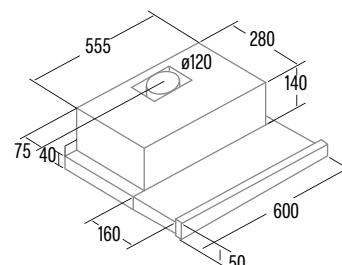

TF-5260 X

Cod.: **02034310** EAN: **8422248082129**



- ▶ **Sliding Control Panel**
- ▶ 3 extraction levels
- ▶ Extraction power: **325m³/h** - 175m³/h (EU Model)
- ▶ Motor maximum airflow free outlet: 350m³/h
- ▶ Sound power: **54dB(A)**, maximum: 68dB(A)
- ▶ 2 Motor. Maximum energy consumption **2 x 65W**
- ▶ LED E-14 lighting
- ▶ Energy Class: D

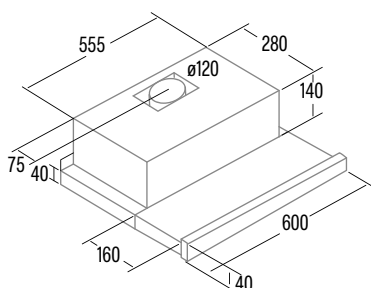

TF-5260 WH

Cod.: **02034501** EAN: **8422248082136**



- ▶ **Sliding Control Panel**
- ▶ 3 extraction levels
- ▶ Extraction power: **325m³/h** - 175m³/h (EU Model)
- ▶ Motor maximum airflow free outlet: 350m³/h
- ▶ Sound power: **54dB(A)**, maximum: 68dB(A)
- ▶ 2 Motor. Maximum energy consumption **2 x 65W**
- ▶ LED E-14 lighting
- ▶ Energy Class: D

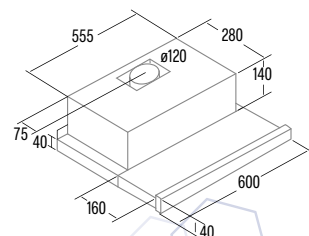

TFB-5160 X

Cod.: **02034606** EAN: **8422248101998**



- ▶ **Mechanical control panel**
- ▶ 2 extraction levels
- ▶ Extraction power: **345m³/h** - 175m³/h
- ▶ Motor maximum airflow free outlet: 700m³/h
- ▶ Sound power: **51dB(A)**, maximum: 61dB(A)
- ▶ Tangential motor. Extra silent. Maximum energy consumption **65W**
- ▶ High efficiency Compact STRIP LED lighting
- ▶ Energy Class: B

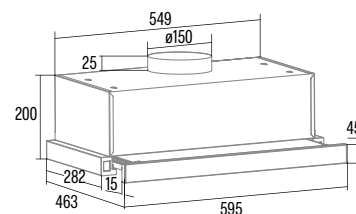

TFB-5160 BK

Cod.: 02034408 EAN: 8422248108096



- ▶ **Mechanical control panel**
- ▶ 2 extraction levels
- ▶ Extraction power: **345m³/h** - 175m³/h
- ▶ Motor maximum airflow free outlet: 700m³/h
- ▶ Sound power: **51dB(A)**, maximum: 61dB(A)
- ▶ Tangential motor. Extra silent. Maximum energy consumption **65W**
- ▶ High efficiency Compact Strip LED lighting
- ▶ Energy Class: B

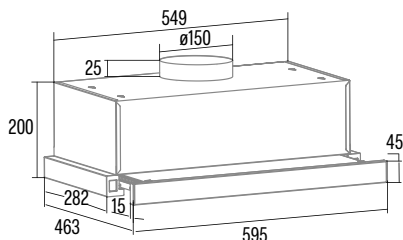

TFB-5160 WH

Cod.: 02034107 EAN: 8422248102001



- ▶ **Mechanical control panel**
- ▶ 2 extraction levels
- ▶ Extraction power: **345m³/h** - 175m³/h
- ▶ Motor maximum airflow free outlet: 700m³/h
- ▶ Sound power: **51dB(A)**, maximum: 61dB(A)
- ▶ Tangential motor. Extra silent. Maximum energy consumption **65W**
- ▶ High efficiency Compact Strip LED lighting
- ▶ Energy Class: B

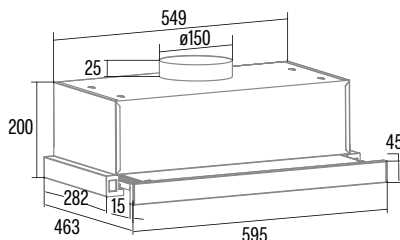

TF-5250 X

Cod.: 02097305 EAN: 8422248086264



- ▶ **Sliding Control Panel**
- ▶ 3 extraction levels
- ▶ Extraction power: **325m³/h** - 175m³/h
- ▶ Motor maximum airflow free outlet: 350m³/h
- ▶ Sound power: **54dB(A)**, maximum: 68dB(A)
- ▶ 2 Motor. Maximum energy consumption **2 x 65W**
- ▶ LED E-14 lighting
- ▶ Energy Class: D

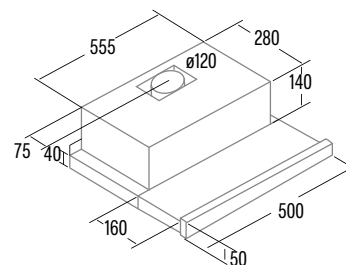

TFB-5150 X

Cod.: 02097306 EAN: 8422248102018

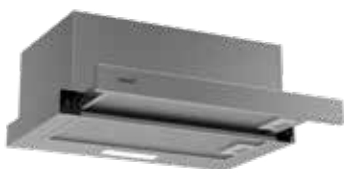

- ▶ **Mechanical control panel**
- ▶ 2 extraction levels
- ▶ Extraction power: **300m³/h** - 160m³/h
- ▶ Motor maximum airflow free outlet: 700m³/h
- ▶ Sound power: **48dB(A)**, maximum: 61dB(A)
- ▶ Tangential motor. Extra silent. Maximum energy consumption **65W**
- ▶ High efficiency Strip LED lighting
- ▶ Energy Class: C

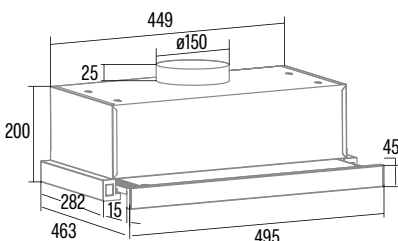

TFK 6005 X

Cod.: 02034604 EAN: 8422248357234



- ▶ **Mechanical Control Panel**
- ▶ 2 extraction levels
- ▶ Extraction power: **390m³/h** - 186m³/h
- ▶ Motor maximum airflow free outlet: 600m³/h
- ▶ Sound power: **54dB(A)**, maximum: 68dB(A)
- ▶ K11 motor. Maximum energy consumption 103W
- ▶ High efficiency Strip Led lighting
- ▶ **Energy Class: A**

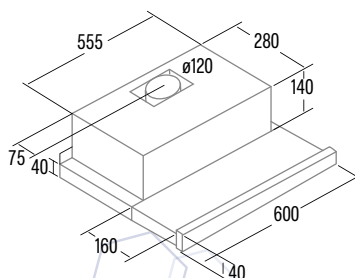

TFK 6005 WH

Cod.: 02034505 EAN: 8422248357227



- ▶ **Mechanical Control Panel**
- ▶ 2 extraction levels
- ▶ Extraction power: **162m³/h** - 108m³/h
- ▶ Motor maximum airflow free outlet: 600m³/h
- ▶ Sound power: **49dB(A)**, maximum: 58dB(A)
- ▶ K11 motor. Maximum energy consumption 103W
- ▶ High efficiency Strip Led lighting
- ▶ **Energy Class: A**

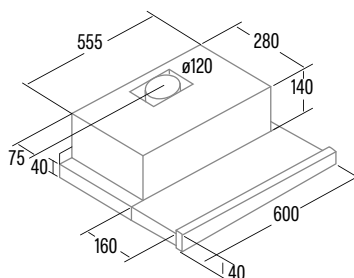

LFK 6001 X

Cod.: **02011603** EAN: **8422248371308**



NEW

- ▶ **Mechanical control panel**
- ▶ 3 extraction levels
- ▶ Extraction power: **162m³/h** - 108m³/h
- ▶ Motor maximum airflow free outlet: 230m³/h
- ▶ Sound power: **49dB(A)**, maximum: 58dB(A)
- ▶ L1B motor. Maximum energy consumption **55W**
- ▶ E-14 LED lighting
- ▶ Energy Class: B

LFK 6001 WH

Cod.: **0201112** EAN: **8422248371315**



NEW

- ▶ **Mechanical control panel**
- ▶ 3 extraction levels
- ▶ Extraction power: **162m³/h** - 108m³/h
- ▶ Motor maximum airflow free outlet: 230m³/h
- ▶ Sound power: **49dB(A)**, maximum: 58dB(A)
- ▶ L1B motor. Maximum energy consumption **55W**
- ▶ E-14 LED lighting
- ▶ Energy Class: B

LFK 6001 WH + FCA

Cod.: **02011121** EAN: **8422248371322**



NEW

- ▶ **Mechanical control panel**
- ▶ 3 extraction levels
- ▶ Extraction power: **162m³/h** - 108m³/h
- ▶ Motor maximum airflow free outlet: 230m³/h
- ▶ Sound power: **49dB(A)**, maximum: 58dB(A)
- ▶ L1B motor. Maximum energy consumption **55W**
- ▶ E-14 LED lighting
- ▶ **Carbon filter included**
- ▶ Energy Class: B

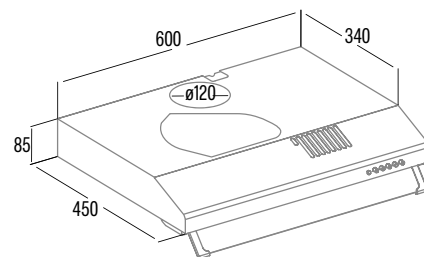
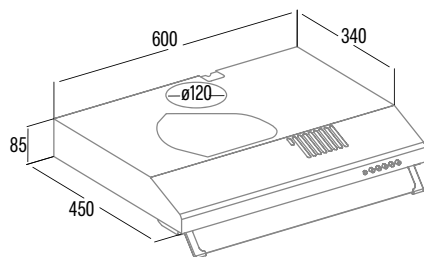
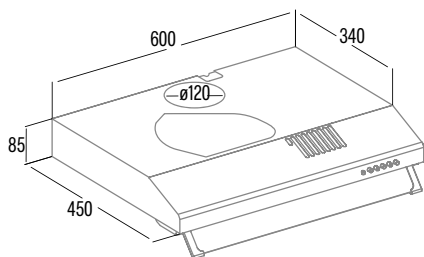

LFK 6000 X

Cod.: **02011602** EAN: **8422248357180**



- ▶ **Rocker Control Panel**
- ▶ 2 extraction levels
- ▶ Extraction power: **162m³/h** - 108m³/h
- ▶ Motor maximum airflow free outlet: 230m³/h
- ▶ Sound power: **49dB(A)**, maximum: 58dB(A)
- ▶ L1B motor. Maximum energy consumption **55W**
- ▶ E-14 LED lighting
- ▶ Energy Class: B

LFK 6000 WH

Cod.: **02011117** EAN: **8422248357197**



- ▶ **Rocker Control Panel**
- ▶ 2 extraction levels
- ▶ Extraction power: **162m³/h** - 108m³/h
- ▶ Motor maximum airflow free outlet: 230m³/h
- ▶ Sound power: **49dB(A)**, maximum: 58dB(A)
- ▶ L1B motor. Maximum energy consumption **55W**
- ▶ E-14 LED lighting
- ▶ Energy Class: B

F-2050 X

Cod.: **02015306** EAN: **8422248086103**



- ▶ **Mechanical control panel**
- ▶ 3 extraction levels
- ▶ Extraction power: **195m³/h** - 108m³/h
- ▶ Motor maximum airflow free outlet: 350m³/h
- ▶ Sound power: **56dB(A)**, maximum: 68dB(A)
- ▶ 1 motor x **60W**
- ▶ E-14 LED lighting
- ▶ Energy Class: C

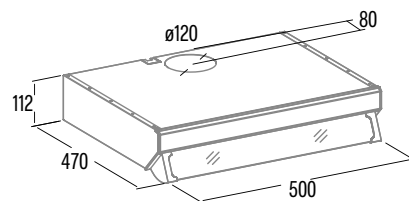
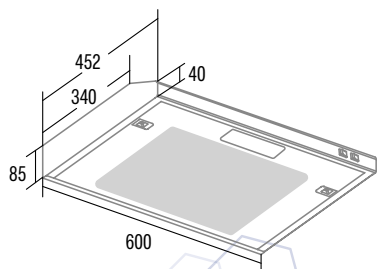
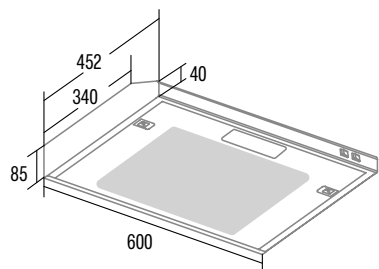

F-2050 WH

Cod.: **02015006** EAN: **8422248086110**



- ▶ **Mechanical control panel**
- ▶ 3 extraction levels
- ▶ Extraction power: **195m³/h** - 108m³/h
- ▶ Motor maximum airflow free outlet: 350m³/h
- ▶ Sound power: **56dB(A)**, maximum: 68dB(A)
- ▶ 1 motor x **60W**
- ▶ E-14 LED lighting
- ▶ Energy Class: C

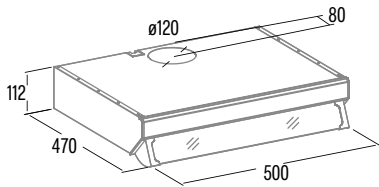

F-2290 X

Cod.: **02014302** EAN: **8422248168946**



- ▶ **Sliding control panel**
- ▶ 3 extraction levels
- ▶ Minimum sound power: **59dB(A)**, maximum: 65dB(A)
- ▶ Motor maximum airflow free outlet: 380m³/h
- ▶ 2 motors. Maximum energy consumption 2 x **125W**

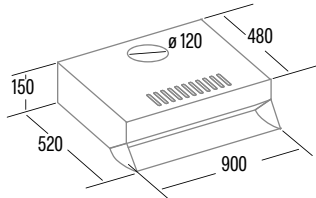

FK SLIM 6000 BK

Cod.: **02011504** EAN: **8422248357258**



- ▶ **Mechanical Control Panel**
- ▶ 3 extraction levels
- ▶ Extraction power: **162m³/h** - 108m³/h
- ▶ Motor maximum airflow free outlet: 350m³/h
- ▶ Sound power: **49dB(A)**, maximum: 58dB(A)
- ▶ Maximum energy consumption **55W**
- ▶ E-14 LED lighting
- ▶ Energy Class: B

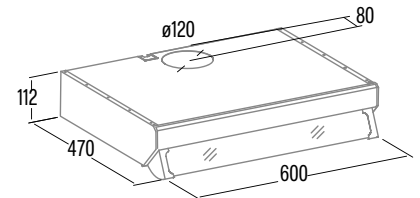

FK SLIM 6000 X

Cod.: **02011604** EAN: **8422248357241**



- ▶ **Mechanical Control Panel**
- ▶ 3 extraction levels
- ▶ Extraction power: **162m³/h** - 108m³/h
- ▶ Motor maximum airflow free outlet: 350m³/h
- ▶ Sound power: **49dB(A)**, maximum: 58dB(A)
- ▶ Maximum energy consumption **55W**
- ▶ E-14 LED lighting
- ▶ Energy Class: B

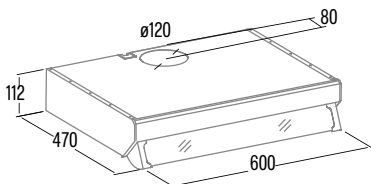

FK SLIM 6000 WH

Cod.: **02011204** EAN: **8422248357265**



- ▶ **Mechanical Control Panel**
- ▶ 3 extraction levels
- ▶ Extraction power: **162m³/h** - 108m³/h
- ▶ Motor maximum airflow free outlet: 350m³/h
- ▶ Sound power: **49dB(A)**, maximum: 58dB(A)
- ▶ Maximum energy consumption **55W**
- ▶ E-14 LED lighting
- ▶ Energy Class: B

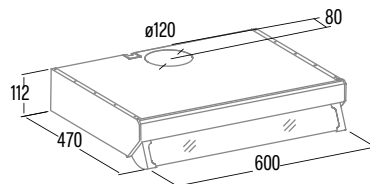

KITCHEN EXTRACTORS

PROFESSIONAL
750

Cod.: 00117000 EAN: 8422248100816



- ▶ Extraction power: **600m³/h**
- ▶ Sound power: **49dB(A)**
- ▶ Maximum energy consumption: **105W**
- ▶ **Metal grease filter with plate to collect grease washable in dishwasher**
- ▶ Metal housing and plastic impeller.
- ▶ 120mm outlet diameter
- ▶ Energy Class: C

PROFESSIONAL
750 L

Cod.: 00117100 EAN: 8422248100823



- ▶ Extraction power: **600m³/h**
- ▶ Sound power: **49dB(A)**
- ▶ Maximum energy consumption: **119W**
- ▶ LED E-14 lighting
- ▶ **Metal grease filter with plate to collect grease washable in dishwasher**
- ▶ Metal housing and plastic impeller.
- ▶ 120mm outlet diameter
- ▶ Energy Class: D

PROFESSIONAL
500

Cod.: 00117400 EAN: 8422248010832



- ▶ Extraction power: **450m³/h**
- ▶ Sound power: **57dB(A)**
- ▶ Maximum energy consumption: 125W
- ▶ **Metal grease filter with plate to collect grease washable in dishwasher**
- ▶ Plastic housing and impeller
- ▶ 100 mm outlet diameter
- ▶ Energy Class: D

GS-600 PLUS2 VEL.

Cod.: 00116110 EAN: 8422248006316



- ▶ 2 extraction levels
- ▶ Extraction power: **600/420m³/h**
- ▶ Sound power: **52dB(A)**
- ▶ Maximum energy consumption: **105W**
- ▶ Metal housing and plastic impeller.
- ▶ 2 speeds switch that can be wall mounted
- ▶ 120 mm outlet diameter
- ▶ Energy Class: C

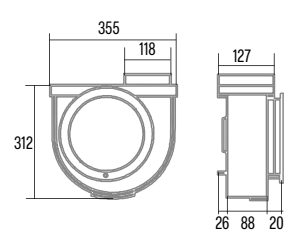
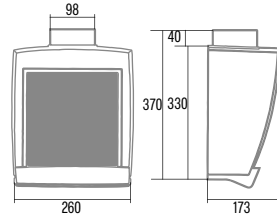
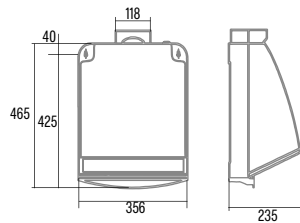
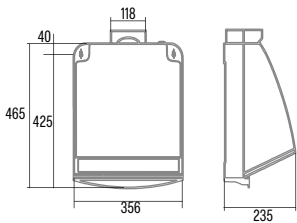

GS-600 BK

Cod.: 00116400 EAN: 8422248357371



- ▶ Extraction power: **480m³/h**
- ▶ Sound power: **50dB(A)**
- ▶ Maximum energy consumption: **105W**
- ▶ Metal housing and plastic impeller.
- ▶ 110 mm outlet diameter
- ▶ Energy Class: C

GS-600

Cod.: 00116002 EAN: 8422248100601



- ▶ Extraction power: **480m³/h**
- ▶ Sound power: **50dB(A)**
- ▶ Maximum energy consumption: **105W**
- ▶ Metal housing and plastic impeller.
- ▶ 110 mm outlet diameter
- ▶ Energy Class: C

GS-400 M

Cod.: 00114102 EAN: 8422248100403



- ▶ Extraction power: **290m³/h**
- ▶ Sound power: **52dB(A)**
- ▶ Maximum energy consumption: **60W**
- ▶ Metal housing and standard protection guard
- ▶ 110 mm outlet diameter
- ▶ Energy Class: B

GS-400 P

Cod.: 00111002 EAN: 8422248100830



- ▶ Extraction power: **290m³/h**
- ▶ Sound power: **52dB(A)**
- ▶ Maximum energy consumption: **60W**
- ▶ Thermal plastic housing and standard protection guard
- ▶ 110 mm outlet diameter
- ▶ Energy Class: B

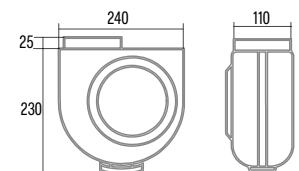
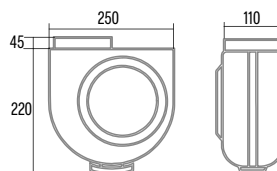
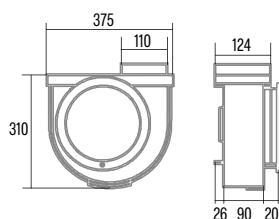
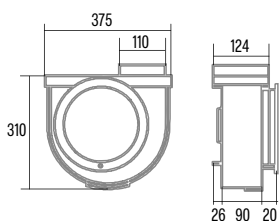

MULTIFUNCTION OVENS

MT 8012 BK cata & Can Rocca

Cod.: 07002411 EAN: 8422248094009



- ▶ **Multifunction oven with Fan forced** oven 11 functions
- ▶ **Touch control panel**
- ▶ Display cooking programmer with temperature and times
- ▶ Chromed support with 5 cooking levels
- ▶ **1 Telescopic guide** full extension adaptable to any level
- ▶ 3 glazed cool door with tangential ventilation
- ▶ Accessories: **Deep tray**, tray, grid and pizza stone
- ▶ **Automatic AquaSmart Cleaning system**
- ▶ Net capacity **72 liters**
- ▶ **Energy Class A**

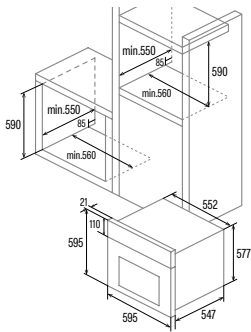

MT 8012 WH cata & Can Rocca

Cod.: 07002412 EAN: 8422248094016



- ▶ **Multifunction oven with Fan forced** oven 11 functions
- ▶ **Touch control panel**
- ▶ Display cooking programmer with temperature and times
- ▶ Chromed support with 5 cooking levels
- ▶ **1 Telescopic guide** full extension adaptable to any level
- ▶ 3 glazed cool door with tangential ventilation
- ▶ Accessories: **Deep tray**, tray, grid and pizza stone
- ▶ **Automatic AquaSmart Cleaning system**
- ▶ Net capacity **72 liters**
- ▶ **Energy Class A**

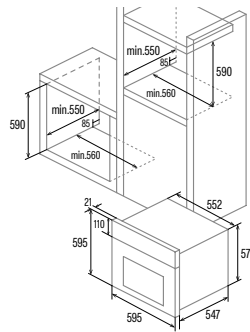

PR 6011 XGBK

Cod.: 07001006 EAN: 8422248103350



- ▶ **Pyrolytic oven with Fan forced** oven 10 functions
- ▶ **Push/Pull controls**
- ▶ Display cooking programmer with temperature and times
- ▶ Chromed support with 5 cooking levels
- ▶ **1 Telescopic guide** adaptable to any level 50%
- ▶ Glazed cool door with tangential ventilation 4 glasses
- ▶ Accessories: tray and grid
- ▶ **Pyrolytic cleaning with 2 levels (90/120 min)**
- ▶ Net capacity **70 liters**
- ▶ **Energy class A**

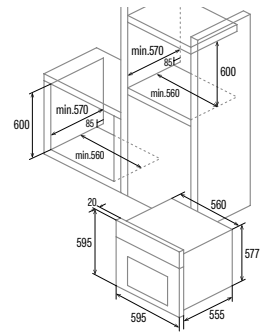

MD 6106X

Cod.: 07033303 EAN: 8422248076029



- ▶ **Multifunction oven - 6 functions**
- ▶ **Display cooking programmer** with temperature and times
- ▶ 5 levels for placing trays
- ▶ Double glazed cool door with tangential ventilation
- ▶ Accessories: tray and grid
- ▶ **AquaSmart Cleaning system**
- ▶ Net capacity **60 liters**
- ▶ **Energy Class A**

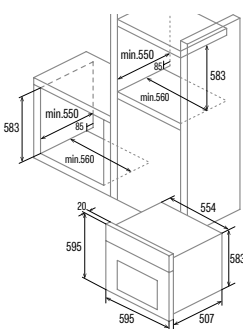

ME 6206 X

Cod.: 07007303 EAN: 8422248075886



- ▶ **Multifunction oven - 6 functions**
- ▶ **Mechanical cooking programmer**
- ▶ 5 levels for placing trays
- ▶ Double glazed cool door with tangential ventilation
- ▶ Accessories: tray and grid
- ▶ **AquaSmart Cleaning system**
- ▶ Net capacity **60 liters**
- ▶ **Energy Class A**

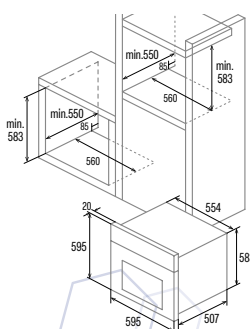

SE 6204 X

Cod.: 07044600 EAN: 8422248075831



- ▶ **Static oven - 4 functions**
- ▶ 5 levels for placing trays
- ▶ Double glazed cool door with tangential ventilation
- ▶ Accessories: Tray and grid
- ▶ Net capacity **65 liters**
- ▶ **Energy Class A**

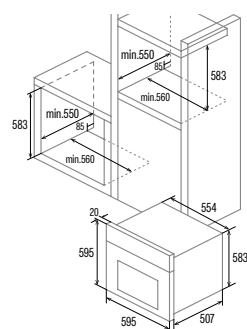

MDS 8008 X AIR FRYER

Cod.: **07001509** EAN: **8422248347846**



- ▶ **Multifunction oven with Fan forced oven** - 8 functions
- ▶ **Push/Pull controls**
- ▶ Display cooking programmer
- ▶ **Airfry function**
- ▶ Chromed support with 5 cooking levels
- ▶ **1 Telescopic guide** adaptable to any level 50%
- ▶ Glazed cool door with tangential ventilation 2 glasses
- ▶ Accessories: **Deep tray**, tray and grid
- ▶ **Automatic AquaSmart Cleaning system**
- ▶ Net capacity **80 liters**
- ▶ **Energy Class A**

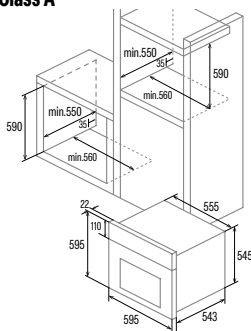

MDS 8008 WH

Cod.: **07001010** EAN: **8422248347679**



- ▶ **Multifunction oven with Fan forced oven** - 8 functions
- ▶ **Push/Pull controls**
- ▶ Display cooking programmer
- ▶ Chromed support with 5 cooking levels
- ▶ **1 Telescopic guide** adaptable to any level 50%
- ▶ Glazed cool door with tangential ventilation 2 glasses
- ▶ Accessories: **Deep tray**, tray and grid
- ▶ **Automatic AquaSmart Cleaning system**
- ▶ Net capacity **80 liters**
- ▶ **Energy Class A**

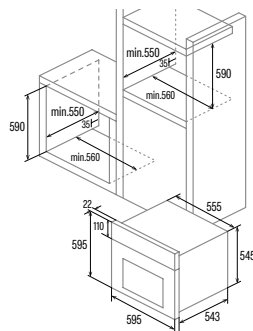

MDS 8008 BK

Cod.: **07001405** EAN: **8422248347655**



- ▶ **Multifunction oven with Fan forced oven** - 8 functions
- ▶ **Push/Pull controls**
- ▶ Display cooking programmer
- ▶ Chromed support with 5 cooking levels
- ▶ **1 Telescopic guide** adaptable to any level 50%
- ▶ Glazed cool door with tangential ventilation 2 glasses
- ▶ Accessories: **Deep tray**, tray and grid
- ▶ **Automatic AquaSmart Cleaning system**
- ▶ Net capacity **80 liters**
- ▶ **Energy Class A**

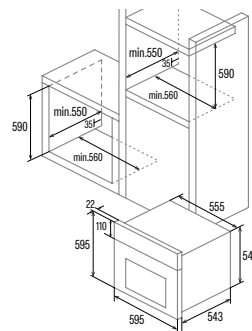

MDS 8008 X

Cod.: **07001508** EAN: **8422248347662**



- ▶ **Multifunction oven with Fan forced oven** - 8 functions
- ▶ **Push/Pull controls**
- ▶ Display cooking programmer
- ▶ Chromed support with 5 cooking levels
- ▶ **1 Telescopic guide** adaptable to any level 50%
- ▶ Glazed cool door with tangential ventilation 2 glasses
- ▶ Accessories: **Deep tray**, tray and grid
- ▶ **Automatic AquaSmart Cleaning system**
- ▶ Net capacity **80 liters**
- ▶ **Energy Class A**

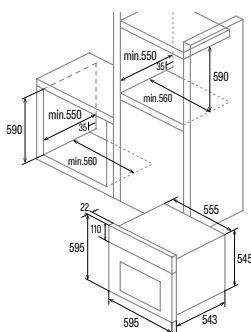

MDS 8007 WH

Cod.: **07034101** EAN: **8422248347709**



- ▶ **Multifunction oven** - 7 functions
- ▶ **Display cooking programmer**
- ▶ Chromed support with 5 cooking levels
- ▶ **1 Telescopic guide** adaptable to any level 50%
- ▶ Glazed cool door with tangential ventilation 2 glasses
- ▶ Accessories: **Deep tray**, tray and grid
- ▶ Net capacity **80 liters**
- ▶ **Energy Class A**

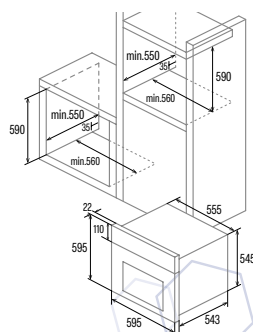

MDS 8007 BK

Cod.: **07034508** EAN: **8422248347693**



- ▶ **Multifunction oven** - 7 functions
- ▶ **Display cooking programmer**
- ▶ Chromed support with 5 cooking levels
- ▶ **1 Telescopic guide** adaptable to any level 50%
- ▶ Glazed cool door with tangential ventilation 2 glasses
- ▶ Accessories: **Deep tray**, tray and grid
- ▶ Net capacity **80 liters**
- ▶ **Energy Class A**

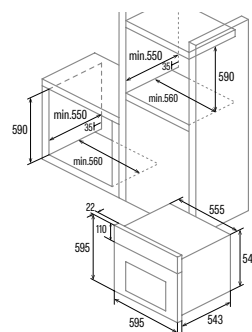

MDS 8007 X

Cod.: 07034605 EAN: 8422248347686



- ▶ Multifunction oven - 7 functions
- ▶ Display cooking programmer
- ▶ Chromed support with 5 cooking levels
- ▶ 1 Telescopic guide adaptable to any level 50%
- ▶ Glazed cool door with tangential ventilation 2 glasses
- ▶ Accessories: Deep tray, tray and grid
- ▶ Net capacity 80 liters
- ▶ Energy Class A

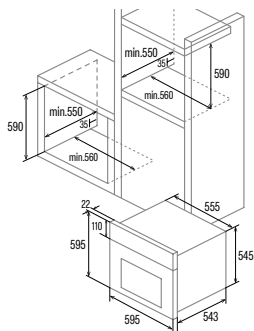

MDS 8007 FB

Cod.: 07034606 EAN: 8422248373173



- ▶ Multifunction oven - 7 functions
- ▶ Display cooking programmer
- ▶ Chromed support with 5 cooking levels
- ▶ 1 Telescopic guide adaptable to any level 50%
- ▶ Glazed cool door with tangential ventilation 2 glasses
- ▶ Accessories: Deep tray, tray and grid
- ▶ Net capacity 80 liters
- ▶ Energy Class A

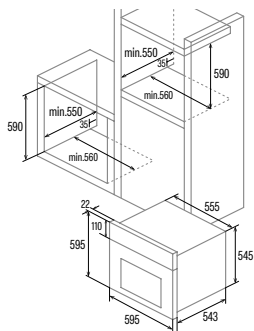

MES 8007 X

Cod.: 07044609 EAN: 8422248347716



- ▶ Multifunction - 7 functions
- ▶ Mechanical cooking programmer with automatic stop
- ▶ Chromed support with 5 cooking levels
- ▶ 1 Telescopic guide adaptable to any level 50%
- ▶ Glazed cool door with tangential ventilation 2 glasses
- ▶ Accessories: Deep tray and grid
- ▶ Net capacity 80 liters
- ▶ Energy Class A

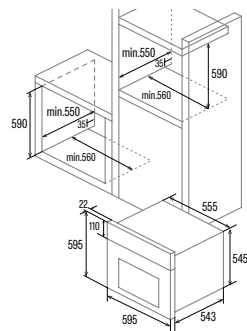

STATIC OVENS

SES 7104 X

Cod.: 07044350 EAN: 8422248347297



- ▶ Static oven - 4 functions
- ▶ Mechanical cooking programmer with automatic stop
- ▶ Chromed support with 5 cooking levels
- ▶ Glazed cool door with tangential ventilation 2 glasses
- ▶ Accessories: Deep tray and grid
- ▶ AquaSmart Cleaning system
- ▶ Net capacity 78 liters
- ▶ Energy Class A

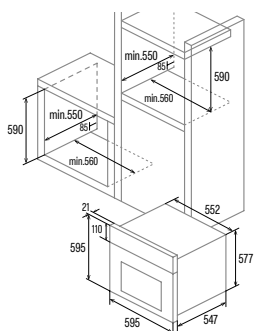

SES 6204 WH

Cod.: 07044105 EAN: 8422248347730



- ▶ Static oven - 4 functions
- ▶ Mechanical cooking programmer with automatic stop
- ▶ Chromed support with 5 cooking levels
- ▶ Glazed cool door with tangential ventilation 2 glasses
- ▶ Accessories: Deep tray and grid
- ▶ AquaSmart Cleaning system
- ▶ Net capacity 66 liters
- ▶ Energy Class A

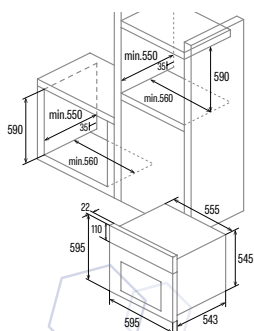

SES 6004 BK

Cod.: 07044614 EAN: 8422248347839



- ▶ Static oven - 4 functions
- ▶ Chromed support with 5 cooking levels
- ▶ Glazed cool door with tangential ventilation 2 glasses
- ▶ Accessories: tray
- ▶ AquaSmart Cleaning system
- ▶ Net capacity 62 liters
- ▶ Energy Class A

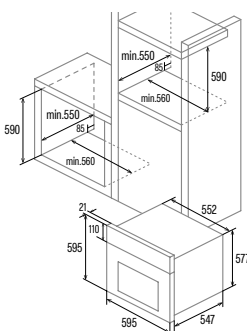

RUSTIC OVENS

SES 6004 WH

Cod.: **07044613** EAN: **8422248347754**



- ▶ **Static oven** - 4 functions
- ▶ Chromed support with 5 cooking levels
- ▶ Glazed cool door with tangential ventilation 2 glasses
- ▶ Accessories: tray
- ▶ **AquaSmart Cleaning system**
- ▶ Net capacity **62 liters**
- ▶ **Energy Class A**

SES 7004 X

Cod.: **07044351** EAN: **8422248347235**



- ▶ **Static oven** - 4 functions
- ▶ Chromed support with 5 cooking levels
- ▶ Glazed cool door with tangential ventilation 2 glasses
- ▶ Accessories: tray
- ▶ Net capacity **65 liters**
- ▶ **Energy Class A**

MRA 7108 BK

Cod.: **07035409** EAN: **8422248077026**



- ▶ **Multifunction oven** - 7 functions
- ▶ **Mechanical cooking programmer**
- ▶ Temperature range 40°C-240°C
- ▶ Panoramic easy-to-clean full glass door with removable inner glass
- ▶ Double glazed cool door with tangential ventilation
- ▶ **AquaSmart cleaning system**
- ▶ Net capacity **60 liters**
- ▶ **Energy Class A**

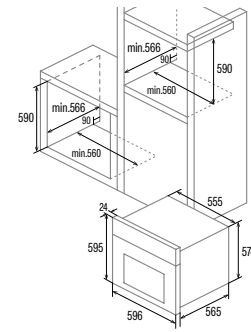
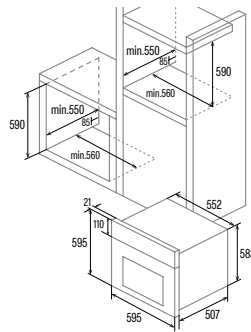
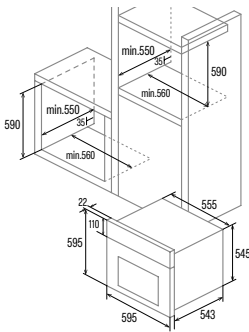

MRA 7108 WH

Cod.: **07035009** EAN: **8422248077033**



- ▶ **Multifunction oven** - 7 functions
- ▶ **Mechanical cooking programmer**
- ▶ Temperature range 40°C-240°C
- ▶ Panoramic easy-to-clean full glass door with removable inner glass
- ▶ Double glazed cool door with tangential ventilation
- ▶ **AquaSmart cleaning system**
- ▶ Net capacity **60 liters**
- ▶ **Energy Class A**

COMPACT OVENS

CMD 5008 X

Cod.: **07003307** EAN: **8422248067881**



- ▶ **Multifunction oven** - 8 functions
- ▶ **Push/Pull controls**
- ▶ Digital cooking programmer
- ▶ 4 levels for placing easy-to-move trays
- ▶ **1 Telescopic guide** full extension adaptable to any level
- ▶ Triple glazed cool door with tangential ventilation
- ▶ Accessories: **Deep tray** and grid
- ▶ **AquaSmart Cleaning system**
- ▶ **Built into a 45 cm unit**
- ▶ Net capacity **40 liters**
- ▶ **Energy Class A**

MD 5008 WH

Cod.: **07003000** EAN: **8422248067898**



- ▶ **Multifunction oven** - 8 functions
- ▶ **Push/Pull controls**
- ▶ Digital cooking programmer
- ▶ 4 levels for placing easy-to-move trays
- ▶ **1 Telescopic guide** full extension adaptable to any level
- ▶ Triple glazed cool door with tangential ventilation
- ▶ Accessories: **Deep tray** and grid
- ▶ **AquaSmart Cleaning system**
- ▶ **Built into a 45 cm unit**
- ▶ Net capacity **40 liters**
- ▶ **Energy Class A**

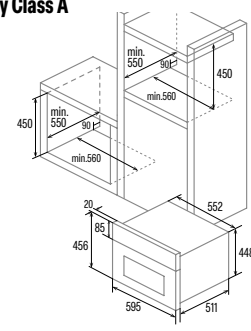
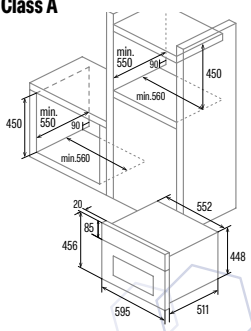
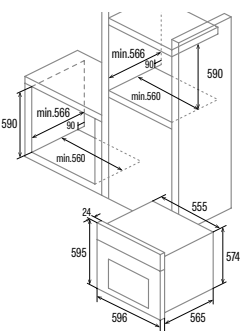

MD 5008 BK

Cod.: 07003001 EAN: 8422248372879



NEW

- ▶ **Multifunction oven** - 8 functions
- ▶ **Push/Pull controls**
- ▶ Display cooking programmer
- ▶ 4 levels for placing easy-to-move trays
- ▶ **1 Telescopic guide** adaptable to any level
- ▶ Triple glazed cool door with tangential ventilation
- ▶ Accessories: **Deep tray** and grid
- ▶ **AquaSmart Cleaning system**
- ▶ Net capacity **40 liters**
- ▶ **Energy Class A**

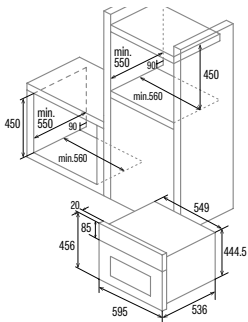

CMD 5007 X

Cod.: 07003002 EAN: 8422248372886



NEW

- ▶ **Multifunction oven** - 6 functions
- ▶ **Push/Pull controls**
- ▶ Display cooking programmer
- ▶ 4 levels for placing easy-to-move trays
- ▶ **1 Telescopic guide** adaptable to any level
- ▶ Triple glazed cool door with tangential ventilation
- ▶ Accessories: **Deep tray** and grid
- ▶ **AquaSmart Cleaning system**
- ▶ Net capacity **40 liters**
- ▶ **Energy Class A**

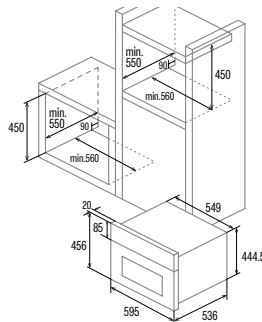

MD 5007 WH

Cod.: 07003003 EAN: 8422248372893



NEW

- ▶ **Multifunction oven** - 6 functions
- ▶ **Push/Pull controls**
- ▶ Display cooking programmer
- ▶ 4 levels for placing easy-to-move trays
- ▶ **1 Telescopic guide** adaptable to any level
- ▶ Triple glazed cool door with tangential ventilation
- ▶ Accessories: **Deep tray** and grid
- ▶ **AquaSmart Cleaning system**
- ▶ Net capacity **40 liters**
- ▶ **Energy Class A**

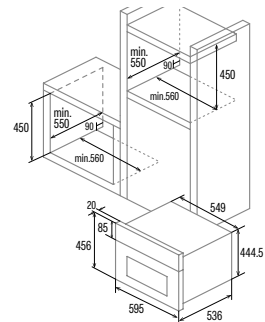

MD 5007 BK

Cod.: 07003004 EAN: 8422248372909



NEW

- ▶ **Multifunction oven** - 6 functions
- ▶ **Push/Pull controls**
- ▶ Display cooking programmer
- ▶ 4 levels for placing easy-to-move trays
- ▶ **1 Telescopic guide** adaptable to any level
- ▶ Triple glazed cool door with tangential ventilation
- ▶ Accessories: **Deep tray** and grid
- ▶ **AquaSmart Cleaning system**
- ▶ Net capacity **40 liters**
- ▶ **Energy Class A**

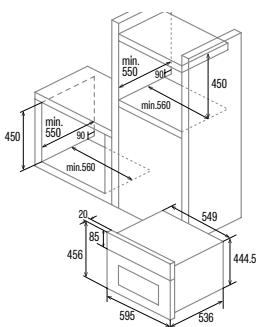

ME 4006 X

Cod.: 07003305 EAN: 8422248067867



- ▶ **Multifunction oven** - 6 functions
- ▶ **Mechanical cooking programmer**
- ▶ 4 levels for placing easy-to-move trays
- ▶ Triple glazed cool door with tangential ventilation
- ▶ Accessories: tray and grid
- ▶ **AquaSmart Cleaning system**
- ▶ **Built into a 45 cm unit**
- ▶ Net capacity **40 liters**
- ▶ **Energy Class A**

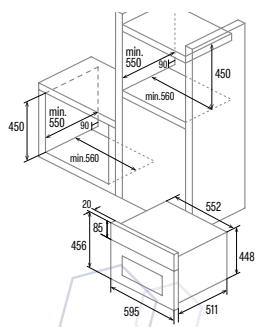

90cm WIDE OVEN

CMD 9208 BK

Cod.: 07039305 EAN: 8422248093156



- ▶ **Multifunction oven** - 8 functions
- ▶ **Push/Pull controls**
- ▶ Digital cooking programmer
- ▶ 5 levels for placing easy-to-move trays
- ▶ Triple glazed cool door
- ▶ Accessories: **Deep tray** and grid
- ▶ Net capacity **93 liters**
- ▶ **Energy Class A**

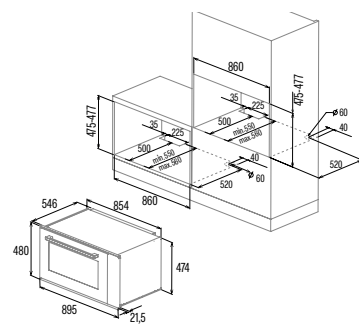

SUITABLE FOR 50cm CABINET

CDP 780 AS BK

Cod.: 07001401 EAN: 8422248059503



- ▶ Multifunction oven - 8 functions
- ▶ Push/Pull controls
- ▶ Digital cooking programmer
- ▶ 4 levels for placing easy-to-move trays
- ▶ 1 telescopic guide
- ▶ Double glazed cool door with tangential ventilation
- ▶ Accessories: Deep tray and grid
- ▶ AquaSmart Cleaning system
- ▶ Net capacity 50 liters
- ▶ Energy Class A

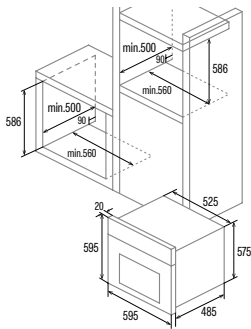

CM 760 AS BK

Cod.: 07032307 EAN: 8422248059497



- ▶ Multifunction oven - 6 functions
- ▶ Mechanical cooking programmer
- ▶ 4 levels for placing easy-to-move trays
- ▶ Double glazed cool door with tangential ventilation
- ▶ Accessories: Deep tray and grid
- ▶ AquaSmart Cleaning system
- ▶ Net capacity 50 liters
- ▶ Energy Class A

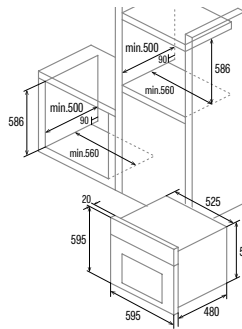

CM 760 AS WH

Cod.: 07032002 EAN: 8422248058568



- ▶ Multifunction oven - 6 functions
- ▶ Mechanical cooking programmer
- ▶ 4 levels for placing easy-to-move trays
- ▶ Double glazed cool door with tangential ventilation
- ▶ Accessories: Deep tray and grid
- ▶ AquaSmart Cleaning system
- ▶ Net capacity 50 liters
- ▶ Energy Class A

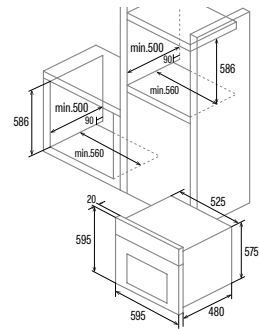

MICROWAVES

cata & Can Rocca

MC25 GTC BK

Cod.: 07510400 EAN: 8422248055277



- ▶ 25 litres, built-in microwave without frame
- ▶ Simultaneous 1,000 W quartz grill
- ▶ Five power levels, 900 W output
- ▶ Timer from 0 to 95 minutes
- ▶ Automatic defrosting by time and weight
- ▶ 8 automatic access menus
- ▶ 2 Combination settings
- ▶ Fast start button

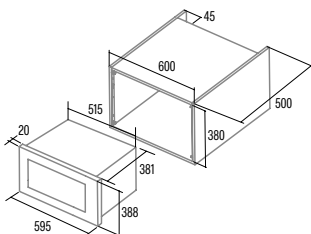

cata & Can Rocca

MC25 GTC WH

Cod.: 07510000 EAN: 8422248055260



- ▶ 25 litres, built-in microwave without frame
- ▶ Simultaneous 1,000 W quartz grill
- ▶ Five power levels, 900 W output
- ▶ Timer from 0 to 95 minutes
- ▶ Automatic defrosting by time and weight
- ▶ 8 automatic access menus
- ▶ 2 Combination settings
- ▶ Fast start button

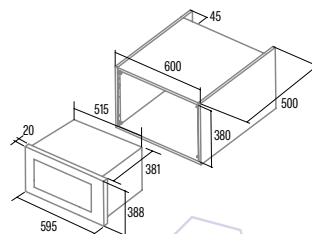

BUILT IN MICROWAVES

MC 32 DC

Cod.: 07510303 EAN: 8422248055253



- ▶ 32 litres, built-in microwave without frame
- ▶ Simultaneous 1,000 W grill
- ▶ Five power levels, 900 W output
- ▶ Convection fan 2,500W (total power)
- ▶ Timer from 0 to 95 minutes
- ▶ Automatic defrosting by time and weight
- ▶ 10 automatic access menus
- ▶ 4 Combination settings
- ▶ Fast start button

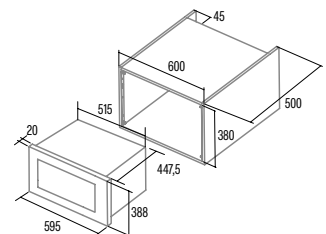

MC 25 D ENC

Cod.: **07510300** EAN: **8422248048453**



- ▶ **25 litres, built-in microwave without frame**
- ▶ 1.000 W grill
- ▶ Five power levels, 900 W output
- ▶ Timer from 0 to 95 minutes
- ▶ Defrosting by time and weight
- ▶ 8 auto cook menus
- ▶ 2 Combination settings
- ▶ Fast start button

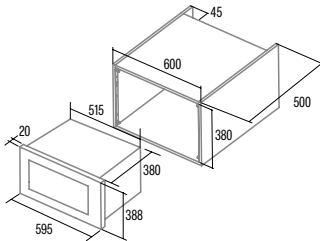

MW BI2505DCG X

Cod.: **07511306** EAN: **8422248108119**



- ▶ **25 litre** built-in microwave
- ▶ 1200 W grill
- ▶ Five power levels, 900 W output
- ▶ Timer from 0 to 60 minutes
- ▶ Defrosting by time and weight
- ▶ 8 auto cook menus

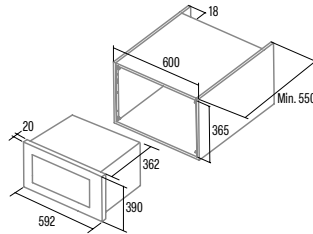

MW BI2505DCG BK

Cod.: **07511402** EAN: **8422248100151**



- ▶ **25 litre** built-in microwave
- ▶ 1200 W grill
- ▶ Five power levels, 900 W output
- ▶ Timer from 0 to 60 minutes
- ▶ Defrosting by time and weight
- ▶ 8 auto cook menus

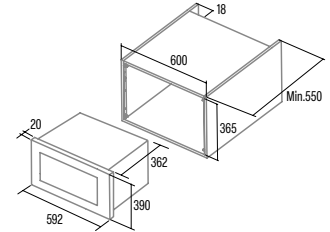

MMA 20 WH

Cod.: **07510003** EAN: **8422248077187**



- ▶ **20 litre** built-in microwave
- ▶ **Installation suitable for High Furniture**
- ▶ **Adjustable in height to fit with furniture**
- ▶ Simultaneous 1,000 W grill
- ▶ Five power levels, 800 W output
- ▶ Timer from 0 to 35 minutes
- ▶ Automatic defrosting by time and weight
- ▶ 3 Combination settings
- ▶ Fast start button

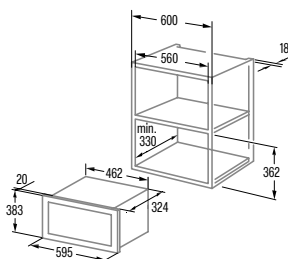

MMA 20 X

Cod.: **07510308** EAN: **8422248077170**



- ▶ **20 litre** built-in microwave
- ▶ **Installation suitable for High Furniture**
- ▶ **Adjustable in height to fit with furniture**
- ▶ Simultaneous 1,000 W grill
- ▶ Five power levels, 800 W output
- ▶ Timer from 0 to 35 minutes
- ▶ Automatic defrosting by time and weight
- ▶ 3 Combination settings
- ▶ Fast start button

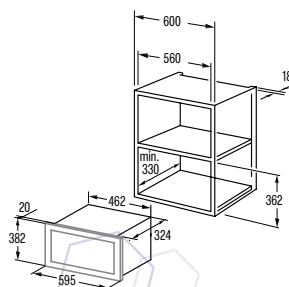

MC 20 D ENC

Cod.: **07510301** EAN: **8422248049450**



- ▶ **20 litre** built-in microwave
- ▶ **Installation suitable for High Furniture**
- ▶ Simultaneous 1,000 W grill
- ▶ Five power levels, 800 W output
- ▶ Timer from 0 to 95 minutes
- ▶ Automatic defrosting by time and weight
- ▶ 8 automatic access menus
- ▶ 2 Combination settings
- ▶ Fast start button

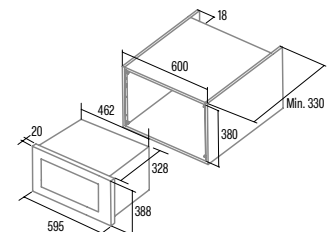

MC 20 D BK

Cod.: 07510312 EAN: 8422248373128

MC 20 M BK

Cod.: 07510313 EAN: 8422248373135

MC 20 IX

Cod.: 07510306 EAN: 8422248058476



NEW



NEW



- ▶ 20 litre built-in microwave
- ▶ Installation suitable for High Furniture
- ▶ Adjustable in height to fit with furniture
- ▶ Simultaneous 800 W grill
- ▶ Five power levels, 700 W output
- ▶ 2 grill power levels
- ▶ 2 Combination settings
- ▶ Timer from 0 to 60 minutes
- ▶ Automatic defrosting by time and weight
- ▶ 6 automatic access menus
- ▶ Fast start button

- ▶ 20 litre built-in microwave
- ▶ Installation suitable for High Furniture
- ▶ Adjustable in height to fit with furniture
- ▶ Simultaneous 800 W grill
- ▶ Five power levels, 700 W output
- ▶ 1 grill power level
- ▶ 3 Combination settings
- ▶ Timer from 0 to 30 minutes
- ▶ Automatic defrosting by time and weight

- ▶ 20 litre built-in microwave
- ▶ Installation suitable for High Furniture
- ▶ Simultaneous 1,000 W grill
- ▶ Five power levels, 800 W output
- ▶ Timer from 0 to 35 minutes
- ▶ Automatic defrosting by time and weight
- ▶ 3 Combination settings

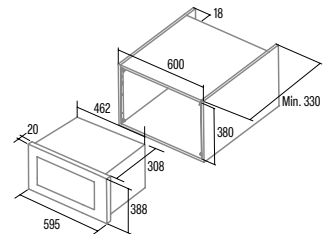
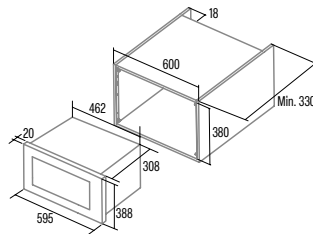
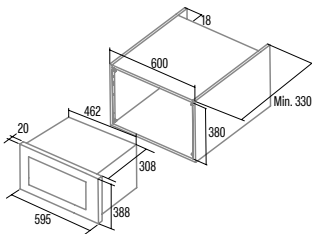

GIGA 750 BK

Cod.: 08026001 EAN: 8422248054485



- ▶ **6 cooking areas:** 6 zones of 237x189mm. 1 modular zone of Ø400mm, 3 modular zones of 237x378mm
- ▶ **Continuous power regulation**
- ▶ **Slider Touch Control for each area**
- ▶ It has **three temperature functions**
- ▶ 9 adjustable power levels + Booster
- ▶ Timer function for each area
- ▶ **Total power 11kW**

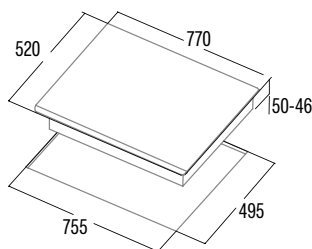

GIGA 600 BK

Cod.: 08026002 EAN: 8422248059190

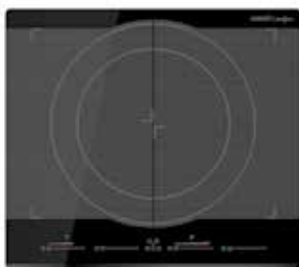

- ▶ **4 cooking areas:** 4 zones of 237x189mm. 1 modular zone of Ø400mm, 2 modular zones of 237x378mm
- ▶ **Continuous power regulation**
- ▶ **Slider Touch Control for each area**
- ▶ It has **three temperature functions**
- ▶ 9 adjustable power levels + Booster
- ▶ Timer function for each area
- ▶ **Total power 7.4kW**

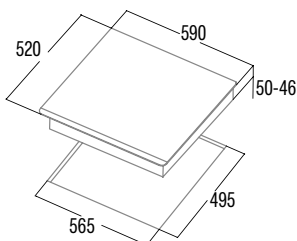

GIGA 600 WH

Cod.: 08026003 EAN: 8422248059206



- ▶ **4 cooking areas:** 4 zones of 237x189mm. 1 modular zone of Ø400mm, 2 modular zones of 237x378mm
- ▶ **Continuous power regulation**
- ▶ **Slider Touch Control for each area**
- ▶ It has **three temperature functions**
- ▶ 9 adjustable power levels + Booster
- ▶ Timer function for each area
- ▶ **Total power 7.4kW**

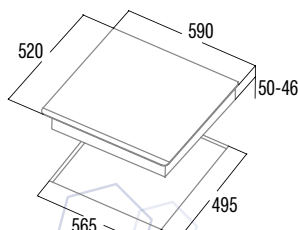

GIGA 600 SD

Cod.: 08026609 EAN: 8422248069014

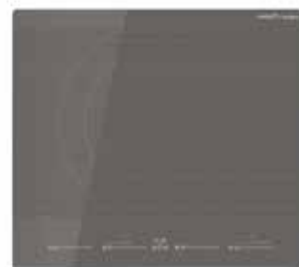

- ▶ **4 cooking areas:** 4 zones of 237x189mm. 1 modular zone of Ø400mm, 2 modular zones of 237x378mm
- ▶ **Continuous power regulation**
- ▶ **Slider Touch Control for each area**
- ▶ It has **three temperature functions**
- ▶ 9 adjustable power levels + Booster
- ▶ Timer function for each area
- ▶ **Total power 7.4kW**

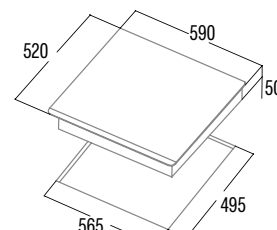

SURFACE INTEGRATION

IAS 7024

Cod.: **08000200** EAN: **8422248358699**

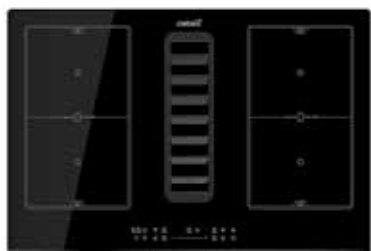

- ▶ **4 cooking areas:** 2 modular double areas measuring 215mm x 380mm of 3.7kW
- ▶ Continuous power regulation
- ▶ **Slider Touch control** panel
- ▶ It has three temperature functions
- ▶ 9 adjustable power levels + Booster
- ▶ **AUTO function. Timer function for each area**
- ▶ Countdown alarm
- ▶ Safety lock
- ▶ **Frontal bevel**
- ▶ **Installation height 17cm**
- ▶ **Adjusting the power, max. 7.4kW**

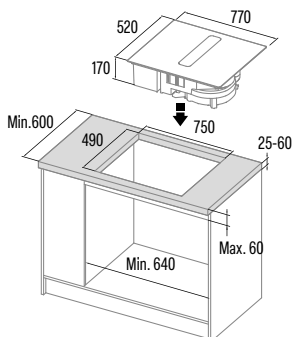

AS 750

Cod.: **08000405** EAN: **8422248109406**

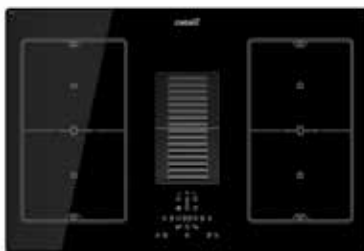

- ▶ **4 cooking areas:** 4 zones of 215x190mm. 2 modular zones of 215x380mm
- ▶ **Slider Touch Control** with acoustic warning
- ▶ 9 adjustable power levels + Booster
- ▶ Countdown alarm
- ▶ Heating/Keeping warm function
- ▶ **Timer function for each area**
- ▶ **Frontal lock**
- ▶ **Total power (induction + extraction) 7.35kW**

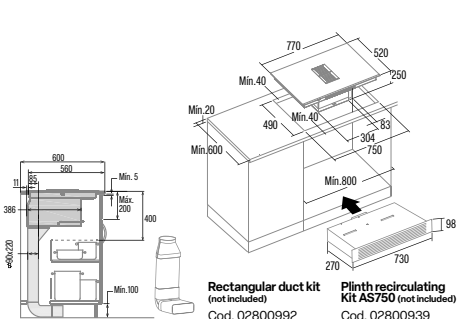

Rectangular duct kit (not included)
Cod. 02800992 EAN 8422248112765

Plinth recirculating Kit AS750 (not included)
Cod. 02800939 EAN 8422248080330

IAS 6024

Cod.: **08000206** EAN: **8422248358705**

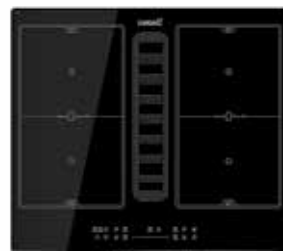

- ▶ **4 cooking areas:** 2 modular double areas measuring 215mm x 380mm of 3.7kW
- ▶ Continuous power regulation
- ▶ **Slider Touch control** panel
- ▶ It has three temperature functions
- ▶ 9 niveles de potencia regulables + Booster
- ▶ **AUTO function. Timer function for each area**
- ▶ Countdown alarm
- ▶ Safety lock
- ▶ **Frontal bevel**
- ▶ **Installation height 17cm**
- ▶ **Adjusting the power, max. 7.4kW**

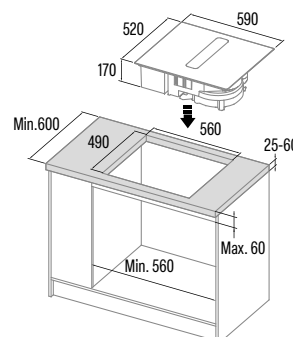

AS 600

Cod.: **08000406** EAN: **8422248198554**



- ▶ **4 cooking areas:** 4 modular double areas measuring 215mm x 380mm of 3.7kW
- ▶ Slider Touch Control with acoustic warning
- ▶ **Touch Control with acoustic warning**
- ▶ 9 adjustable power levels + Booster
- ▶ Heating/Keeping warm function
- ▶ Timer function for each area
- ▶ Countdown alarm
- ▶ Automatic pan detection
- ▶ Safety lock
- ▶ **Total power (induction + extraction) 7.35kW**

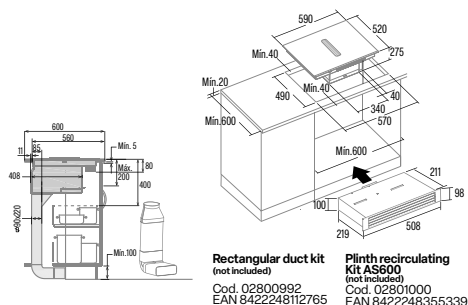

Rectangular duct kit (not included)
Cod. 02800992 EAN 8422248112765

Plinth recirculating Kit AS600 (not included)
Cod. 02801000 EAN 8422248355339

INDUCTION

INSB 9012 BK

Cod.: **08024402** EAN: **8422248109413**

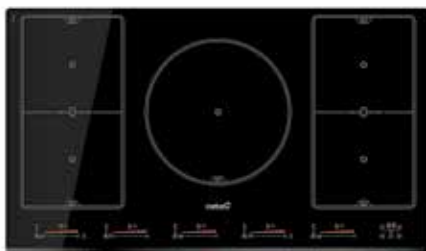

- ▶ **5 cooking areas:** 4 zones of 210x200mm (2 modular zones of 210x400mm), 1 zone of Ø300mm
- ▶ **Slider Touch Control for each area**
- ▶ It has **three temperature functions**
- ▶ 9 adjustable power levels + Booster
- ▶ Pause Function
- ▶ Timer function for each area
- ▶ **Total power 9kW**

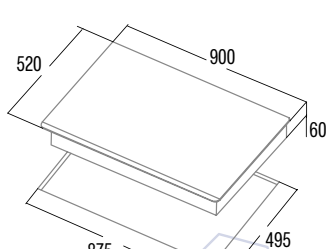

INSB 8021 BK

Cod.: **08081401** EAN: **8422248109536**

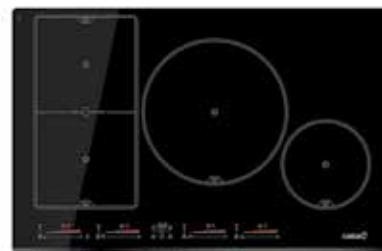

- ▶ **4 cooking areas:** 2 zones of 210x200mm (1 modular zone of 210x400mm), 1 zone of Ø300mm, 1 zone of Ø180mm
- ▶ **Slider Touch Control for each area**
- ▶ It has **three temperature functions**
- ▶ 9 adjustable power levels + Booster
- ▶ Pause Function
- ▶ Timer function for each area
- ▶ **Total power 7.2kW**

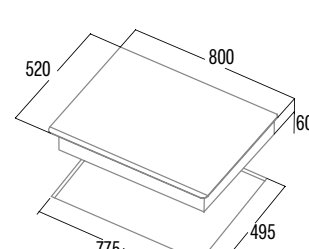

INSB 6032 BK

Cod.: **08063404** EAN: **8422248109482**



- ▶ **3 cooking areas:** 1 zone of Ø320/190mm, 1 zone of Ø210mm, 1 zone of Ø160mm
- ▶ **Continuous power regulation**
- ▶ **Slider Touch Control for each area**
- ▶ It has **three temperature functions**
- ▶ **AUTO connectivity for automatic control of the CATA AUTO hoods**
- ▶ 9 adjustable power levels + Booster
- ▶ Pause Function
- ▶ Timer function for each area
- ▶ **Total power 7.1kW**

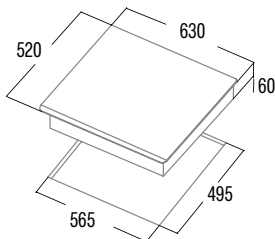

INSB 6030 WH

Cod.: **08053000** EAN: **8422248108607**



- ▶ **3 cooking areas:** 1 zone of Ø300/180mm, 1 zone of Ø210mm, 1 zone of Ø160mm
- ▶ **Continuous power regulation**
- ▶ **Slider Touch Control for each area**
- ▶ It has **three temperature functions**
- ▶ **AUTO connectivity for automatic control of the CATA AUTO hoods**
- ▶ 9 adjustable power levels + Booster
- ▶ Pause Function
- ▶ Timer function for each area
- ▶ **Total power 7.1kW (limitable)**

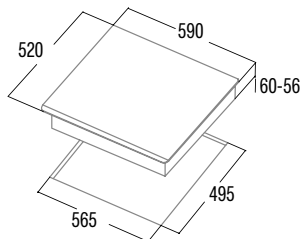

INSB 6028 BK

Cod.: **08063500** EAN: **8422248108577**



- ▶ **3 cooking areas:** 1 zone of Ø280/180mm, 1 zone of Ø210mm, 1 zone of Ø160mm
- ▶ **Continuous power regulation**
- ▶ **Slider Touch Control for each area**
- ▶ It has **three temperature functions**
- ▶ **AUTO 2 connectivity for automatic control of the CATA AUTO 2 hoods**
- ▶ 9 adjustable power levels + Booster
- ▶ Pause Function
- ▶ Timer function for each area
- ▶ **Total power 7.1kW (limitable)**

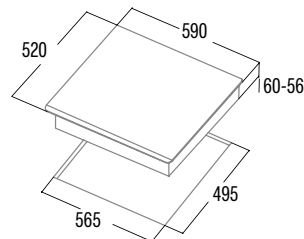

INSB 6003 E2 BK

Cod.: **08063122** EAN: **8422248355735**



- ▶ **3 cooking areas:** 1 zone of Ø300mm, 1 zone of Ø230mm, 1 zone of Ø180mm
- ▶ **Slider Touch Control for each area**
- ▶ It has **three temperature functions**
- ▶ 9 adjustable power levels + Booster
- ▶ Pause Function
- ▶ Timer function for each area
- ▶ Automatic pan detection
- ▶ Safety lock
- ▶ **Installation without front ventilation slot**
- ▶ **Total power 7.1kW (limitable)**

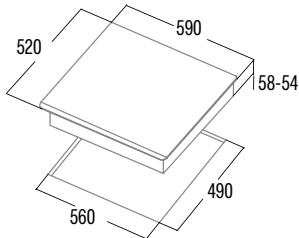

INSB 6003 E2 WH

Cod.: **08063123** EAN: **8422248357159**



- ▶ **3 cooking areas:** 1 zone of Ø300mm, 1 zone of Ø230mm, 1 zone of Ø180mm
- ▶ **Slider Touch Control for each area**
- ▶ It has **three temperature functions**
- ▶ 9 adjustable power levels + Booster
- ▶ Pause Function
- ▶ Timer function for each area
- ▶ Automatic pan detection
- ▶ Safety lock
- ▶ **Installation without front ventilation slot**
- ▶ **Total power 7.1kW (limitable)**

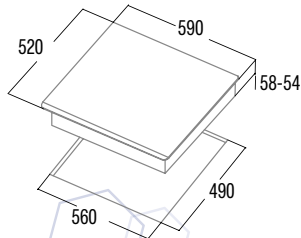

IBS 6303 E2

Cod.: **08063116** EAN: **8422248351836**

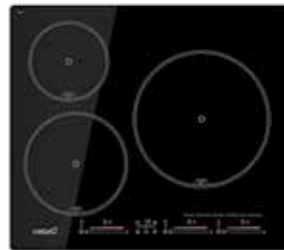

- ▶ **3 cooking areas:** 1 zone of Ø280mm, 1 zone of Ø210mm, 1 zone of Ø160mm
- ▶ **Slider Touch Control for each area**
- ▶ It has **three temperature functions**
- ▶ 9 adjustable power levels + Booster
- ▶ Pause Function
- ▶ Timer function for each area
- ▶ Automatic pan detection
- ▶ Safety lock
- ▶ **Installation without front ventilation slot**
- ▶ **Total power 7.1kW (limitable)**

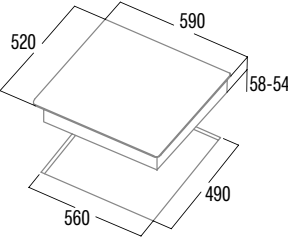

ISB 603 BK

Cod.: **08073212** EAN: **8422248112703**



- ▶ **3 cooking areas:** 1 zone of Ø280mm, 1 zone of Ø210mm, 1 zone of Ø160mm
- ▶ **Slider Touch Control with acoustic warning**
- ▶ 9 adjustable power levels + Booster
- ▶ Timer function for each area
- ▶ **Total power 7.1kW**

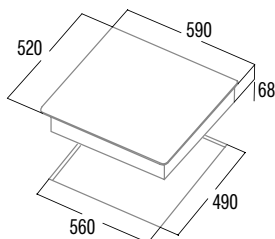

INSB 6004 BK

Cod.: **08040406** EAN: **8422248079594**



- ▶ **4 cooking areas:** 1 booster zone of Ø185mm, 1 booster zone of Ø200mm, 1 booster zone of Ø225mm and 1 booster zone of Ø185mm
- ▶ **Sliding Touch Control**
- ▶ 9 adjustable power levels + Booster
- ▶ Timer function for each area
- ▶ **Total power 7,2kW**

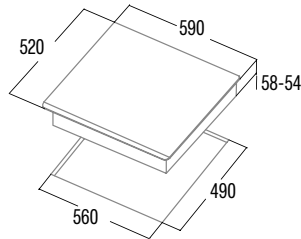

IB 6303 E2 BK

Cod.: **08063120** EAN: **8422248355919**



- ▶ **3 cooking areas:** 1 zone of Ø280mm, 1 zone of Ø210mm, 1 zone of Ø160mm
- ▶ **Slider Touch Control with acoustic warning**
- ▶ It has **three temperature functions**
- ▶ 9 adjustable power levels + Booster
- ▶ Timer function for each area
- ▶ Automatic pan detection
- ▶ Safety lock
- ▶ **Installation without front ventilation slot**
- ▶ **Total power 7.1kW (limitable)**

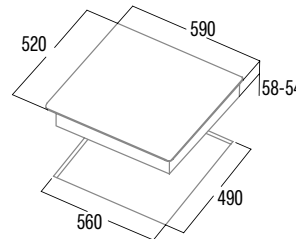

IB 6403 E2 BK

Cod.: **08063121** EAN: **8422248355926**



- ▶ **3 cooking areas:** 1 zone of Ø250mm, 1 zone of Ø180mm, 1 zone of Ø160mm
- ▶ **Slider Touch Control with acoustic warning**
- ▶ **AUTO 2 connectivity for automatic control of the CATA AUTO 2 hoods**
- ▶ 9 adjustable power levels + Booster
- ▶ Timer function for each area
- ▶ Automatic pan detection
- ▶ Safety lock
- ▶ **Installation without front ventilation slot**
- ▶ **Total power 5.3kW (limitable)**

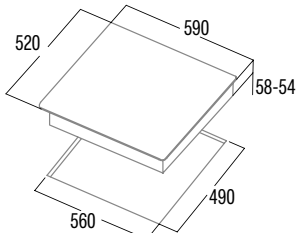

IB 5003 BK

Cod.: **08074007** EAN: **8422248094191**



- ▶ **3 cooking areas:** 1 zone of Ø280mm, 1 zone of Ø210mm, 1 zone of Ø160mm
- ▶ Touch Control with acoustic warning
- ▶ 9 adjustable power levels + Booster
- ▶ Timer function for each area
- ▶ Total power 7.1kW
- ▶ **Automatic pan detection**
- ▶ Safety lock
- ▶ **Total power 5.6kW**

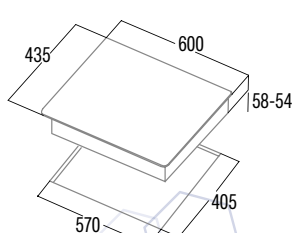

IB 6324 E2 BK

Cod.: **08063119** EAN: **8422248355704**



- ▶ **4 cooking areas:** 1 zone of Ø250mm, 1 zone of Ø180mm, 2 zone of Ø160mm
- ▶ **Slider Touch Control with acoustic warning**
- ▶ It has **three temperature functions**
- ▶ **AUTO 2 connectivity for automatic control of the CATA AUTO 2 hoods**
- ▶ 9 adjustable power levels + Booster
- ▶ Timer function for each area
- ▶ Automatic pan detection
- ▶ Safety lock
- ▶ **Installation without front ventilation slot**
- ▶ **Total power 7kW (limitable)**

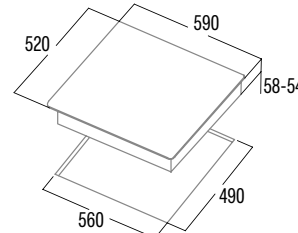

IB 6304 E2 BK

Cod.: 08001206 EAN: 8422248355278



- ▶ **4 cooking areas:** 4 cooking areas: 2 zone of Ø180mm, 2 zones of Ø160mm
- ▶ **Touch Control with acoustic warning**
- ▶ It has **three temperature functions**
- ▶ 9 niveles de potencia regulables + Booster
- ▶ Timer function for each area
- ▶ Countdown alarm
- ▶ **Automatic pan detection**
- ▶ Safety lock
- ▶ **Adjusting the power, max. 7kW**

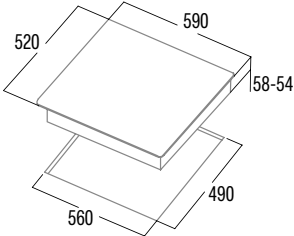

IB 753 BK

Cod.: 08081202 EAN: 8422248054478



- ▶ **3 cooking areas:** 1 zone of Ø270mm, 1 zone of Ø220mm, 1 zone of Ø180mm
- ▶ **Touch Control with acoustic warning**
- ▶ 9 adjustable power levels + Booster
- ▶ Timer function for each area
- ▶ **Total power 6.7kW**

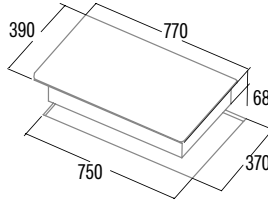

IB 073 BK

Cod.: 08081100 EAN: 8422248075473



- ▶ **3 cooking areas:** 1 zone of Ø270mm, 1 zone of Ø220mm, 1 zone of Ø180mm
- ▶ **Slider Touch Control with acoustic warning**
- ▶ 9 adjustable power levels + Booster
- ▶ Timer function for each area
- ▶ **Total power 6.7kW**

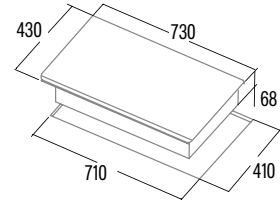

IB 853 BK

Cod.: 08081210 EAN: 8422248109529



- ▶ **3 cooking areas:** 1 zone of Ø270mm, 1 zone of Ø220mm, 1 zone of Ø180mm
- ▶ **Touch Control with acoustic warning**
- ▶ 9 adjustable power levels + Booster
- ▶ Timer function for each area
- ▶ **Total power 6.7kW**

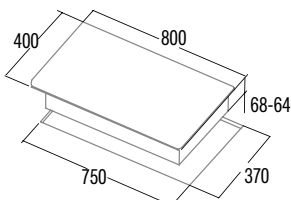

IB 772

Cod.: 08027206 EAN: 8422248091787



- ▶ **2 cooking areas:** 1 zone of Ø270mm, 1 zone of Ø200mm
- ▶ **Slider Touch Control with acoustic warning**
- ▶ 9 adjustable power levels + Booster
- ▶ Timer function for each area
- ▶ **Total power 6kW**

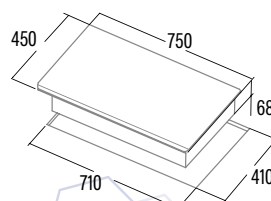

IB 4002 BK

Cod.: 08060010 EAN: 8422248373166



- ▶ **2 cooking areas:** 1 of Ø280/180mm, 1 of Ø160mm
- ▶ Slider Touch Control with acoustic warning
- ▶ It has **three temperature functions**
- ▶ **AUTO 2 connectivity for automatic control of the CATA AUTO 2 hoods**
- ▶ 9 adjustable power levels + Booster
- ▶ Timer function for each area
- ▶ Countdown alarm
- ▶ Automatic pan detection
- ▶ Safety lock
- ▶ Frontal bevel
- ▶ **Total power 4,2kW**

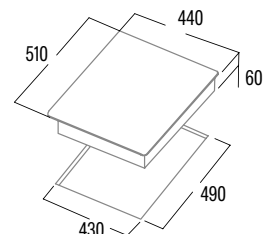

IB 2 PLUS BK

Cod.: 08027208 EAN: 8422248109420



- ▶ **2 cooking areas:** 1 zone of Ø220mm, 1 zone of Ø180mm
- ▶ **Touch Control with acoustic warning**
- ▶ 9 adjustable power levels + Booster
- ▶ Timer function for each area
- ▶ **Total power 3.5kW**

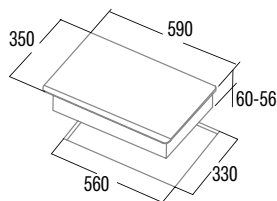

ISB 3102 BK

Cod.: 08003405 EAN: 8422248109314



- ▶ **2 cooking areas:** 1 zone of Ø200mm, 1 zone of Ø180mm
- ▶ **Slider Touch Control with acoustic warning**
- ▶ 9 adjustable power levels + Booster
- ▶ Timer function for each area
- ▶ **Total power 3.5kW**

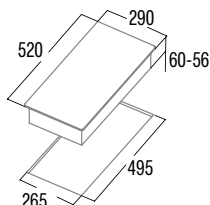

TTS 6032

Cod.: 08063214 EAN: 8422248373142



- ▶ **3 High Light cooking areas:** 1 zone of ø320/260/210mm, 1 zone of Ø180mm, 1 zone of Ø140mm
- ▶ **Slider Touch Control with acoustic warning**
- ▶ 9 adjustable power levels
- ▶ Timer function for each area
- ▶ Automatic safety switch-off
- ▶ Safety lock
- ▶ Frontal bevel
- ▶ **Total power 7kW**

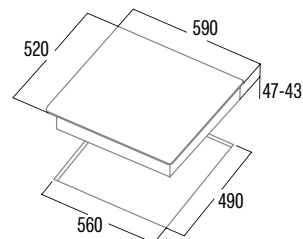

TDM 6003

Cod.: 08063413 EAN: 8422248357357

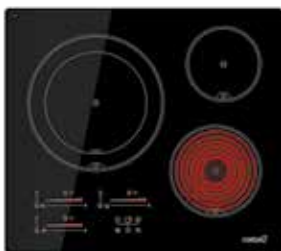

- ▶ **3 High Light cooking areas:** 1 zone of ø280/200mm, 1 zone of Ø180mm, 1 zone of Ø140mm
- ▶ **Slider Touch Control for each area**
- ▶ 9 adjustable power levels
- ▶ **Timer function for each area**
- ▶ Automatic safety switch-off
- ▶ **Safety lock**
- ▶ **Total power 5.4kW**

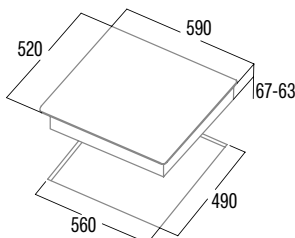

TT 6004

Cod.: 08063215 EAN: 8422248373159



- ▶ **4 High Light cooking areas:** 1 zone of Ø210/140mm, 2 zones of Ø180mm, 1 zone of Ø140mm
- ▶ **Slider Touch Control with acoustic warning**
- ▶ 9 adjustable power levels
- ▶ **Timer function for each area**
- ▶ Automatic safety switch-off
- ▶ Safety lock
- ▶ **Total power 7kW**

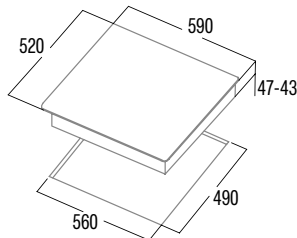

TN 604

Cod.: 08040011 EAN: 8422248109321

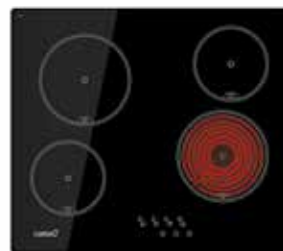

- ▶ **4 cooking areas:** 2 zone of Ø180mm, 2 zone of Ø140mm
- ▶ **Touch Control with acoustic warning**
- ▶ 9 adjustable power levels
- ▶ Timer
- ▶ Safety Lock
- ▶ Residual heat indicator
- ▶ **Total power 6kW**

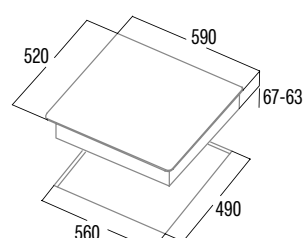

604 HVI

Cod.: **08072202** EAN: **8422248109505**



- ▶ **4 cooking areas:** 2 zone of Ø195mm, 2 zone of Ø160mm
- ▶ **Mechanical controls**
- ▶ 9 adjustable power levels
- ▶ Residual heat indicator
- ▶ **Total power 6kW**

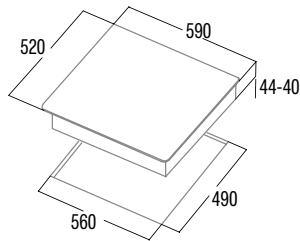

TT 6003

Cod.: **08063212** EAN: **8422248109475**



- ▶ **3 cooking areas:** 1 zone of ø280/220/150mm, 1 zone of Ø185mm, 1 zone of Ø150mm
- ▶ **Touch Control with acoustic warning**
- ▶ 9 adjustable power levels
- ▶ Timer
- ▶ Automatic safety switch-off
- ▶ Safety lock
- ▶ **Total power 5.7kW**

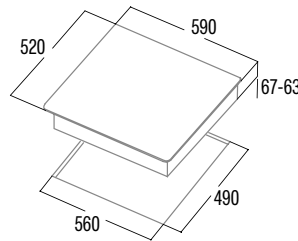

TD 6003 BK

Cod.: **08063411** EAN: **8422248109499**



- ▶ **3 cooking areas:** 1 zone of ø270/210mm, 1 zone of Ø180mm, 1 zone of Ø140mm
- ▶ **Touch Control with acoustic warning**
- ▶ 9 adjustable power levels
- ▶ Timer
- ▶ Safety lock
- ▶ Residual heat indicator
- ▶ **Total power 5.4kW**

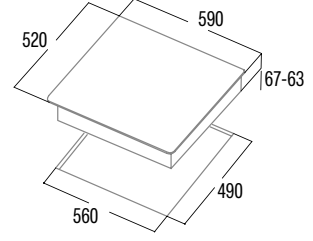

TT 5003

Cod.: **08077001** EAN: **8422248109512**



- ▶ **3 High Light cooking areas:** 1 zone of ø280/220/155mm, 1 zone of Ø185mm, 1 zone of Ø150mm
- ▶ **Touch Control with acoustic warning**
- ▶ 9 adjustable power levels
- ▶ Safety lock
- ▶ Residual heat indicator
- ▶ **Total power 5.7kW**

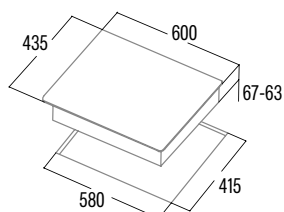

TD 3002 BK

Cod.: **08060405** EAN: **8422248109444**



- ▶ **2 cooking areas:** 1 zone of Ø190/120mm, 1 zone of Ø155mm
- ▶ **Touch Control with acoustic warning**
- ▶ 9 adjustable power levels
- ▶ Timer
- ▶ Safety lock
- ▶ Residual heat indicator
- ▶ **Total power 3.2 kW**

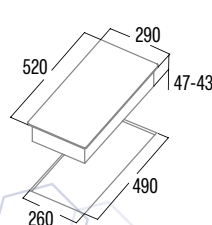

VI 302

Cod.: **08049007** EAN: **8422248109437**



- ▶ **2 cooking areas:** 1 zone of Ø195mm, 1 zone of Ø160mm
- ▶ **Mechanical control**
- ▶ 9 adjustable power levels
- ▶ Residual heat indicator
- ▶ **Total power 3kW**

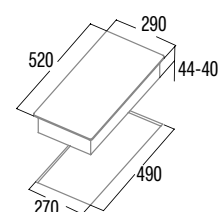

GAS-ON-GLASS HOBS

LCI 9041 BK

Cod.: **08005404** EAN: **8422248081924**



► **5 gas burners:**

- Rear Left: 1 semi-fast of 1.75kW
- Front Left: 1 semi-fast of 1.75kW
- Center: 1 **triple ring** of 3.5kW
- Rear Right: 1 fast of 3kW
- Front Right: 1 auxiliary of 1kW
- One hand automatic ignition
- Flame failure gas cut off safety system
- **Cast iron Grids/burners**
- Suitable for city gas
- LPG nozzles included in the box
- **Total Power 11KW**

L-7005 CI

Cod.: **08046410** EAN: **8422248081962**

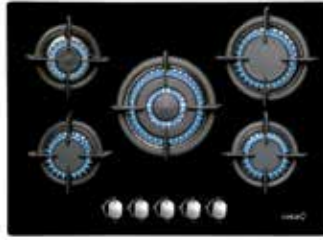

► **5 gas burners:**

- Rear Left: 1 auxiliary of 1kW
- Front Left: 1 semi-fast of 1.75kW
- Center: 1 **triple ring** of 3.5kW
- Rear Right: 1 fast of 3kW
- Front Right: 1 semi-fast of 1,75kW
- One hand automatic ignition
- Flame failure gas cut off safety system
- **Cast iron Grids/burners**
- Suitable for city gas
- LPG nozzles included in the box
- **Total Power 11KW**

LCI 6031 WH

Cod.: **08041100** EAN: **8422248072557**



► **4 gas burners:**

- Rear: 1 fast of 3kW
- Front: 1 semi-fast of 1.75kW
- Right: 1 **triple ring** of 3.5kW
- Left: 1 auxiliary of 1kW
- One hand automatic ignition
- Flame failure gas cut off safety system
- **Cast iron Grids/burners**
- Suitable for city gas
- LPG nozzles included in the box
- **Total Power 9,25KW**

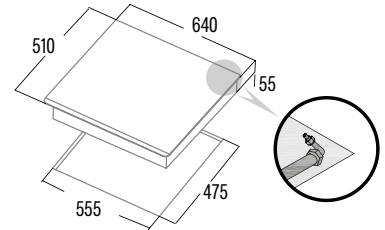
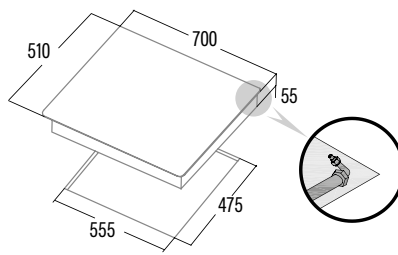
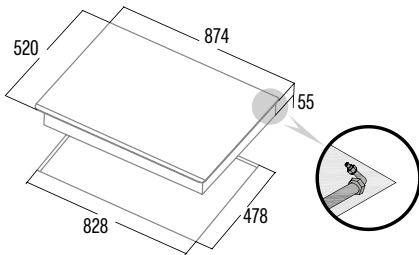

LCI 6031 BK

Cod.: **08041500** EAN: **8422248072724**



► **4 gas burners:**

- Rear: 1 fast of 3kW
- Front: 1 semi-fast of 1.75kW
- Right: 1 **triple ring** of 3.5kW
- Left: 1 auxiliary of 1kW
- One hand automatic ignition
- Flame failure gas cut off safety system
- **Cast iron Grids/burners**
- Suitable for city gas
- LPG nozzles included in the box
- **Total Power 9,25KW**

LCIB 6031 BK

Cod.: **08041503** EAN: **8422248078788**



► **4 gas burners:**

- Rear: 1 fast of 3kW
- Front: 1 semi-fast of 1.75kW
- Right: 1 **triple ring** of 3.5kW
- Left: 1 auxiliary of 1kW
- One hand automatic ignition
- Flame failure gas cut off safety system
- **Cast iron Grids/burners**
- Exclusive Use for LPG Gas
- **Total Power 9,25KW**

CCI 6031 BK

Cod.: **08041501** EAN: **8422248073691**



► **4 gas burners:**

- Rear Left: 1 semi-fast of 1.75kW
- Front Left: 1 **triple ring** of 3.5kW
- Rear Right: 1 semi-fast of 1.75kW
- Front Right: 1 auxiliary of 1kW
- One hand automatic ignition
- Flame failure gas cut off safety system
- **Cast iron Grids/burners**
- Suitable for city gas
- LPG nozzles included in the box
- **Total power 8kW**

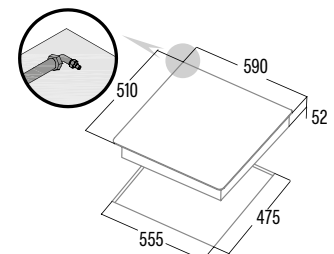
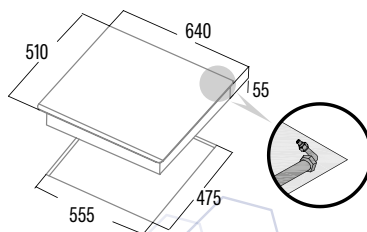
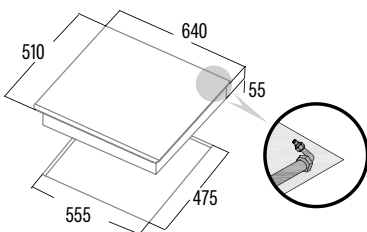

CI 631 BK

Cod.: **08041412** EAN: **8422248058681**



► **4 gas burners:**

Rear Left: 1 semi-fast of 1.75kW
Front Left: 1 **triple ring** of 3.5kW
Rear Right: 1 semi-fast of 1.75kW
Front Right: 1 auxiliary of 1kW

- One hand automatic ignition
- Flame failure gas cut off safety system
- Enamelled Grids/burners
- Suitable for city gas
- LPG nozzles included in the box
- **Total power 8kW**

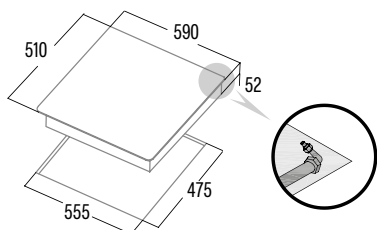

CIB 6031 BK

Cod.: **08068400** EAN: **8422248068352**



► **4 gas burners:**

Rear Left: 1 semi-fast of 1.75kW
Front Left: 1 **triple ring** of 3.5kW
Rear Right: 1 semi-fast of 1.75kW
Front Right: 1 auxiliary of 1kW

- One hand automatic ignition
- Flame failure gas cut off safety system
- Enamelled Grids/burners
- **Exclusive Use for LPG Gas**
- **Total power 8kW**

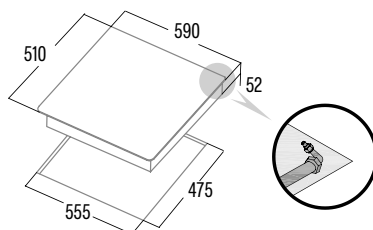

LCI 6021 BK

Cod.: **08068401** EAN: **8422248068376**



► **3 gas burners:**

Rear Right: 1 semi-fast of 1.75kW
Front Right: 1 auxiliary of 1kW
Left: 1 **triple ring** of 3.5kW

- One hand automatic ignition
- Flame failure gas cut off safety system
- **Cast iron Grids/burners**
- Suitable for city gas
- LPG nozzles included in the box
- **Total power 6.25kW**

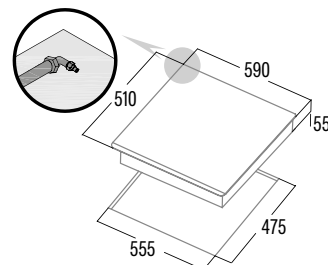

LCIB 6021 BK

Cod.: **08068403** EAN: **8422248078795**



► **3 gas burners:**

Rear Right: 1 semi-fast of 1.75kW
Front Right: 1 auxiliary of 1kW
Left: 1 **triple ring** of 3.5kW

- One hand automatic ignition
- Flame failure gas cut off safety system
- **Cast iron Grids/burners**
- Exclusive Use for LPG Gas
- **Total power 6.25kW**

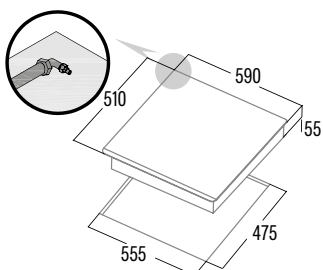

SCI 6021 BK

Cod.: **08068405** EAN: **8422248086929**

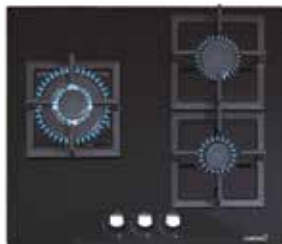

► **3 gas burners:**

Rear Right: 1 semi-fast of 1.75kW
Front Right: 1 auxiliary of 1kW
Left: 1 **triple ring** of 3.5kW

- One hand automatic ignition
- Flame failure gas cut off safety system
- **Cast iron Grids/burners**
- Suitable for city gas
- LPG nozzles included in the box
- **Total power 6.25kW**

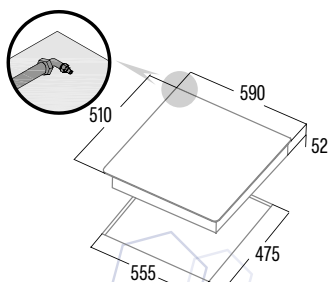

CCI 6021 BK

Cod.: **08068501** EAN: **8422248073707**



► **3 gas burners:**

Rear Right: 1 semi-fast of 1.75kW
Front Right: 1 auxiliary of 1kW
Left: 1 **triple ring** of 3.5kW

- One hand automatic ignition
- Flame failure gas cut off safety system
- **Cast iron Grids/burners**
- Suitable for city gas
- LPG nozzles included in the box
- **Total power 6.25kW**

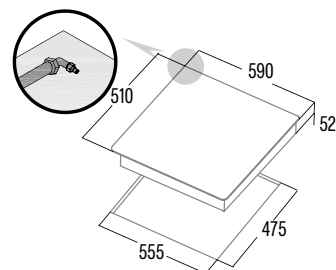

CI 6021 BK

Cod.: **08068309** EAN: **8422248067355**



- ▶ **3 gas burners:**
- Rear Right: 1 semi-fast of 1.75kW
- Front Right: 1 auxiliary of 1kW
- Left: 1 **triple ring** of 3.5kW
- ▶ One hand automatic ignition
- ▶ Flame failure gas cut off safety system
- ▶ Enamelled Grids/burners
- ▶ Suitable for city gas
- ▶ LPG nozzles included in the box
- ▶ **Total power 6.25kW**

CIB 6021 BK

Cod.: **08068402** EAN: **8422248073677**



- ▶ **3 gas burners:**
- Rear Right: 1 semi-fast of 1.75kW
- Front Right: 1 auxiliary of 1kW
- Left: 1 **triple ring** of 3.5kW
- ▶ One hand automatic ignition
- ▶ Flame failure gas cut off safety system
- ▶ Enamelled Grids/burners
- ▶ Exclusive Use for LPG Gas
- ▶ **Total power 6.25kW**

CCI 5003 BK

Cod.: **08041505** EAN: **8422248094269**



- ▶ **3 gas burners:**
- Rear Right: 1 semi-fast of 1.75kW
- Front Right: 1 auxiliary of 1kW
- Left: 1 **triple ring** of 3.5kW
- ▶ One hand automatic ignition
- ▶ Flame failure gas cut off safety system
- ▶ **Cast iron Grids/burners**
- ▶ Suitable for city gas
- ▶ LPG nozzles included in the box
- ▶ **Total power 6.25kW**

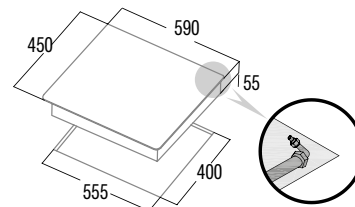
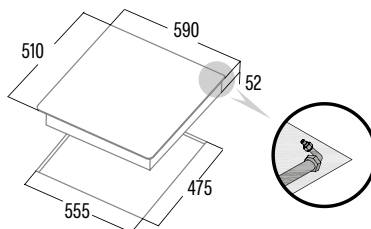
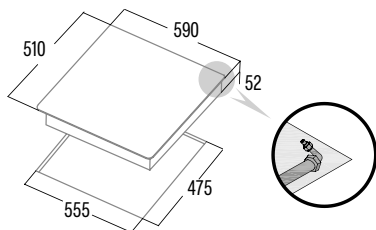

SCI 3002 BK

Cod.: **08047410** EAN: **8422248093743**



- ▶ **2 gas burners:**
- Rear: 1 fast of 3kW
- Front: 1 auxiliary of 1kW
- ▶ One hand automatic ignition
- ▶ Flame failure gas cut off safety system
- ▶ **Cast iron Grids/burners**
- ▶ Suitable for city gas
- ▶ LPG nozzles included in the box
- ▶ **Total Power 4kW**

RUSTIC GAS-ON-GLASS HOB

RCI 631 BK

Cod.: **08028403** EAN: **8422248055024**



- ▶ **4 gas burners:**
- Rear Left: 1 **triple ring** of 3.5kW
- Front Left: 1 semi-fast of 1.75kW
- Rear Right: 1 semi-fast of 1.75kW
- Front Right: 1 auxiliary of 1kW
- ▶ One hand automatic ignition
- ▶ Flame failure gas cut off safety system
- ▶ **Cast iron Grids/burners**
- ▶ Suitable for city gas
- ▶ LPG nozzles included in the box
- ▶ **Total power 8kW**

STAINLESS STEEL GAS HOBS

LGI 9041 X

Cod.: **08005350** EAN: **8422248081948**



- ▶ **5 gas burners:**
- Rear Left: 1 fast of 3kW
- Front Left: 1 semi-fast of 1.75kW
- Center: 1 **triple ring** of 3.5kW
- Rear Right: 1 semi-fast of 1.75kW
- Front Right: 1 auxiliary of 1kW
- ▶ One hand automatic ignition
- ▶ Flame failure gas cut off safety system
- ▶ **Cast iron Grids/burners**
- ▶ Suitable for city gas
- ▶ LPG nozzles included in the box
- ▶ **Total Power 11KW**

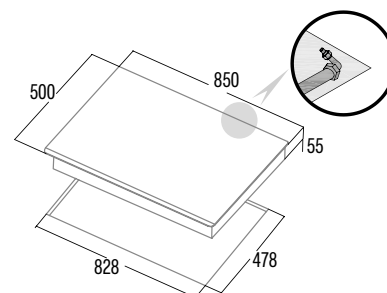
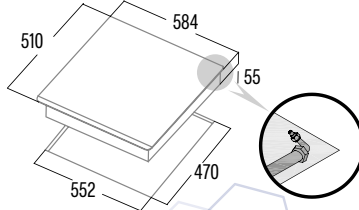
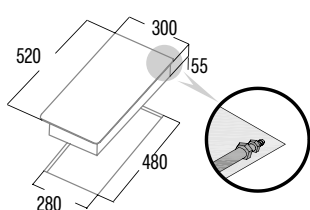

LGI 7041 X

Cod.: **08045305** EAN: **8422248108812**



► **5 gas burners:**

- Rear Left: 1 Semi-fast 1.75 kW
- Front Left: 1 auxiliary 1 kW
- Centre: 1 **triple ring**, 3.5 kW
- Rear Right: 1 fast 3 kW
- Front Right: 1 semi-fast, 1.75 kW
- One hand automatic ignition
- Flame failure gas cut off safety system
- **Cast iron Grids/burners**
- Suitable for city gas
- LPG nozzles included in the box
- **Total Power 11KW**

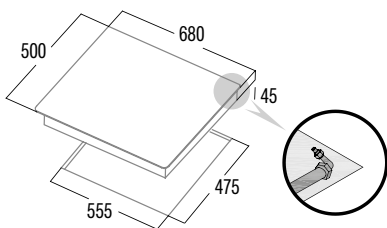

LGD 631 X

Cod.: **08066002** EAN: **8422248058735**



► **4 gas burners:**

- Rear: 1 semi-fast, 1.75 kW
- Front: 1 auxiliary, 1 kW
- Right: 1 **triple ring**, 3.5 kW
- Left: 1 fast, 3 kW
- One hand automatic ignition
- Flame failure gas cut off safety system
- **Cast Iron Grids/burners**
- Suitable for city gas
- LPG nozzles included in the box
- **Total Power 9.25kW**

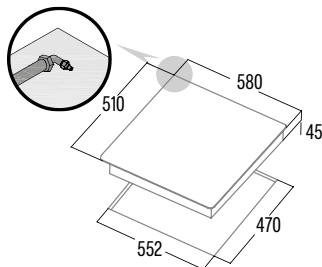

GI 6031 X

Cod.: **08066011** EAN: **8422248067331**



► **4 gas burners:**

- Rear Left: 1 semi-fast, 1.75 kW
- Front Left: 1 **triple ring** of 3.5 kW
- Rear Right: 1 semi-fast, 1.75 kW
- Front Right: 1 auxiliary, 1 kW
- One hand automatic ignition
- Flame failure gas cut off safety system
- Enamelled Grids/burners
- Suitable for city gas
- LPG nozzles included in the box
- **Total power 8kW**

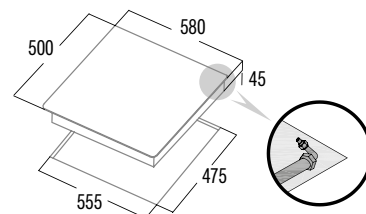

GI 6004 X

Cod.: **08066600** EAN: **8422248067775**



► **4 gas burners:**

- Rear Left: 1 semi-fast, 1.75 kW
- Front Left: 1 fast, 3 kW
- Rear Right: 1 semi-fast, 1.75 kW
- Front Right: 1 auxiliary, 1 kW
- One hand automatic ignition
- Flame failure gas cut off safety system
- Enamelled Grids/burners
- Suitable for city gas
- LPG nozzles included in the box
- **Total power 7.5kW**

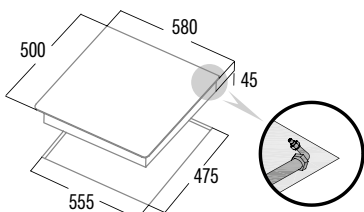

LGI 6031 X

Cod.: **08006301** EAN: **8422248093767**



► **4 gas burners:**

- Rear Left: 1 semi-fast, 1.75 kW
- Front Left: 1 **triple ring** of 3.5 kW
- Rear Right: 1 semi-fast, 1.75 kW
- Front Right: 1 auxiliary, 1 kW
- One hand automatic ignition
- Flame failure gas cut off safety system
- Cast iron Grids/burners
- Suitable for city gas
- LPG nozzles included in the box
- **Total power 8kW**

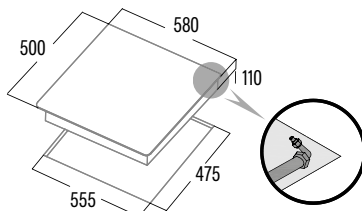

LGI 6004 X

Cod.: **08066607** EAN: **8422248067775**



► **4 gas burners:**

- Rear Left: 1 semi-fast, 1.75 kW
- Front Left: 1 fast, 3 kW
- Rear Right: 1 semi-fast, 1.75 kW
- Front Right: 1 auxiliary, 1 kW
- One hand automatic ignition
- Flame failure gas cut off safety system
- Cast iron Grids/burners
- Suitable for city gas
- LPG nozzles included in the box
- **Total power 7.5kW**

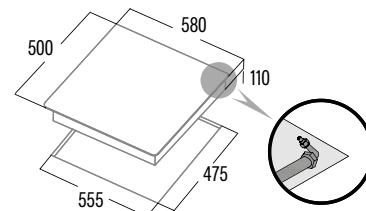

GIB 6004 X

Cod.: **08066312** EAN: **8422248068369**



► **4 gas burners:**

- Rear Left: 1 semi-fast, 1.75kW
- Front Left: 1 fast, 3kW
- Rear Right: 1 semi-fast, 1.75kW
- Front Right: 1 auxiliary, 1kW
- One hand automatic ignition
- Flame failure gas cut off safety system
- Enamelled Grids/burners
- Exclusive Use for LPG Gas
- **Total power 7.5kW**

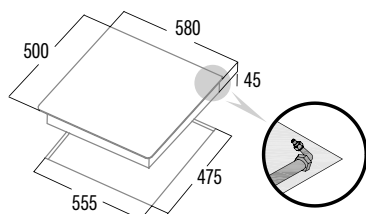

GI 6021 X

Cod.: **08068308** EAN: **8422248067348**



► **3 gas burners:**

- Left: 1 triple ring, 3.5kW
- Rear: 1 semi-fast, 1.75kW
- Front: 1 auxiliary, 1kW
- One hand automatic ignition
- Flame failure gas cut off safety system
- Enamelled Grids/burners
- Suitable for city gas
- LPG nozzles included in the box
- **Total power 6.25kW**

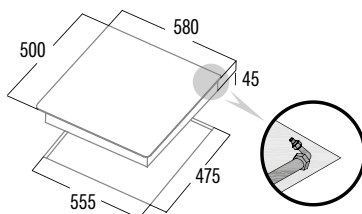

GIB 6021 X

Cod.: **08068310** EAN: **8422248073684**



► **3 gas burners:**

- Left: 1 **triple ring**, 3.5kW
- Rear: 1 semi-fast, 1.75kW
- Front: 1 auxiliary, 1kW
- One hand automatic ignition
- Flame failure gas cut off safety system
- Enamelled Grids/burners
- Exclusive Use for LPG Gas
- **Total power 6.25kW**

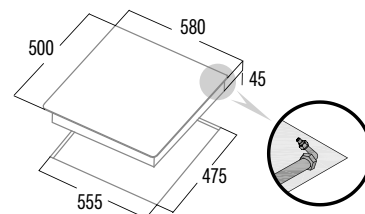

GI 3002 X

Cod.: **08039600** EAN: **8422248108829**



► **2 gas burners:**

- Rear: 1 fast of 3kW
- Front: 1 auxiliary of 1kW
- One hand automatic ignition
- Flame failure gas cut off safety system
- Enameled Grids/burners
- Suitable for city gas
- LPG nozzles included in the box
- **Total Power 4kW**

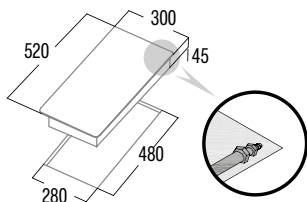

LGI 3002 X

Cod.: **08039601** EAN: **8422248108829**



NEW

► **2 gas burners:**

- Rear: 1 fast of 3kW
- Front: 1 auxiliary of 1kW
- One hand automatic ignition
- Flame failure gas cut off safety system
- Cast iron Grids/burners
- Suitable for city gas
- LPG nozzles included in the box
- **Total Power 4kW**

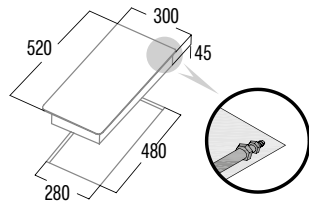

KITCHENWARE

PARRILLA
BARBACOA

Cod.: 03017400

EAN: 8422248082563



- ▶ Suitable for induction.
- ▶ Enamelled Cast Iron. Grill.
- ▶ Nonstick surface
- ▶ Ideal for: searing meat and fish with minimum of fat. Grilling vegetables and fruit.
- ▶ Good heat retention and temperature stability.
- ▶ Robust and durable.
- ▶ Easy to clean

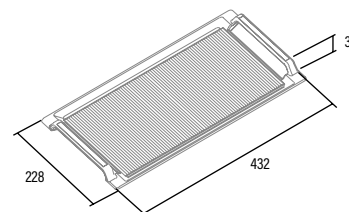

BUILT-IN DISHWASHERS

LVI 62014

Cod.: 07200078 EAN: 8422248351379



- ▶ 14 place settings
- ▶ Energy class D drying and cleaning A
- ▶ 3rd layer cutlery basket
- ▶ 47 dB(A) noise level
- ▶ 8 programs: Intensive, auto, normal, ECO, glass, Express 90', Quick 30'
- ▶ Functions: Program delay 24 h, half load, extradry.
- ▶ automatic opening

LVI 48010

Cod.: 07200080 EAN: 8422248351393



- ▶ 10 place settings
- ▶ Energy class D drying and cleaning A
- ▶ 3rd layer cutlery basket
- ▶ 47 dB(A) noise level
- ▶ 8 programs: Intensive, Auto, normal, ECO, Glass, Express 90', Quick 30'
- ▶ Functions: Program delay 324 h, half load, extradry.
- ▶ automatic opening

LVI 62012

Cod.: 07200079 EAN: 8422248351386



- ▶ 14 place settings
- ▶ Energy class E drying and cleaning A
- ▶ 47 dB(A) noise level
- ▶ 8 programs: Intensive, auto, normal, ECO, glass, Express 90', Quick 30'
- ▶ Functions: Program delay 24 h, half load, extradry., stop/pause

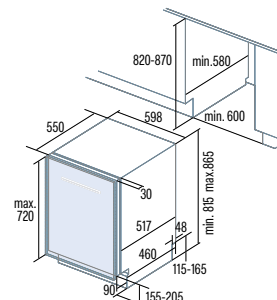
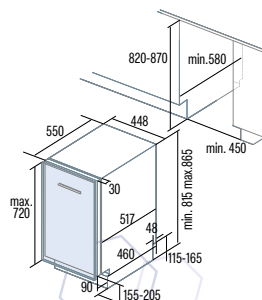
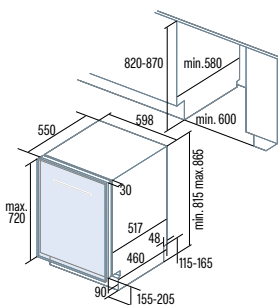

BUILT-IN WASHING MACHINE

LVI 47010

Cod.: **07200081** EAN: **8422248351409**



- ▶ **10 place settings**
- ▶ **Energy class E** drying and cleaning A
- ▶ 47 dB(A) noise level
- ▶ 8 programs: Intensive, auto, normal, ECO, glass, Express 90', Quick 30'
- ▶ Functions: Program delay 24 h, half load, extradry.

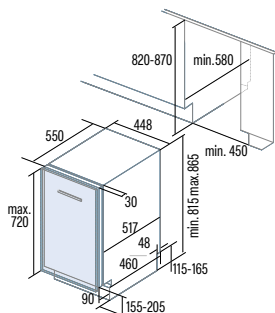

LI 08015

Cod.: **07900005** EAN: **8422248360302**



NEW

- ▶ **8 Kgs capacity**
- ▶ **1400 rpm**
- ▶ **Energy class A**
- ▶ Washing programs: 16
- ▶ Display, program delay 24h, duration and remaining time
- ▶ Foam reduction automatic system
- ▶ Self balanced load
- ▶ Children safety lock

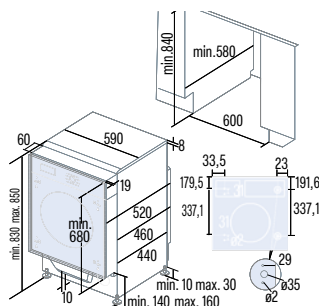

BUILT-IN REFRIGERATORS

CI-54177 ST

Cod.: **07800078** EAN: **8422248350945**



- ▶ 1,77m built in combi fridge
- ▶ **Energy efficiency E**
- ▶ Refrigerator: 1 vegetable drawer, 3 balconies in door and 3 glass shelves
- ▶ Freezer: 3 large capacity drawers
- ▶ Super freeze function
- ▶ Net capacity (l):249 (179+70)
- ▶ Electric consumption:216 kW/year
- ▶ **LED lighting**
- ▶ Sliding door system
- ▶ Reversible doors

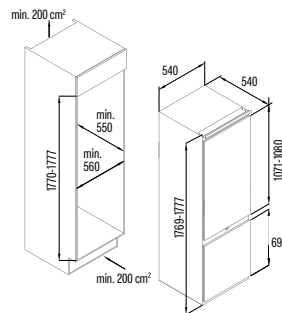

CI-54177 NF

Cod.: **07800080** EAN: **8422248373746**



NEW

- ▶ Combined Total no Frost 1,78 m
- ▶ **Energy efficiency E**
- ▶ **No Frost in Freezer & Fridge**
- ▶ Refrigerator: 1 vegetable drawer, 3 balconies in door and 4 glass shelves
- ▶ Freezer: 2 large capacity drawers
- ▶ Super freeze function
- ▶ Super cooling function
- ▶ Net capacity 248 (180 + 68)
- ▶ Electric consumption: 223 kW/año
- ▶ **LED Lighting**
- ▶ Sliding door system
- ▶ Reversible doors

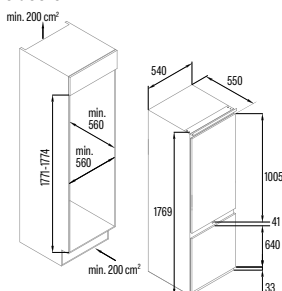

BUILT-IN WINE COOLERS

VI 15107 X

Cod.: **07751006** EAN: **8422248101790**



- ▶ **No frost built-in wine cooler**
- ▶ Capacity **7 bottles**
- ▶ Temperature between 5/20°C.
- ▶ **Electronic temperature control**
- ▶ **Inner LED light**
- ▶ Reversible door
- ▶ Energy class G
- ▶ Sound level 41 dB

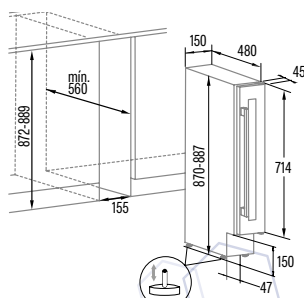

VI 30117 X

Cod.: **07751007** EAN: **8422248101806**



- ▶ **No frost built-in wine cooler**
- ▶ Capacity **17 bottles**
- ▶ Dual Temperature zone between 5/22°C
- ▶ 5/13° for white without oak-aging period, sweet, rosé and champagne
- ▶ 13/22° for white with oak-aging, red
- ▶ **Electronic temperature control**
- ▶ **Inner LED light**
- ▶ Reversible door
- ▶ Energy class G
- ▶ Sound level 41dB

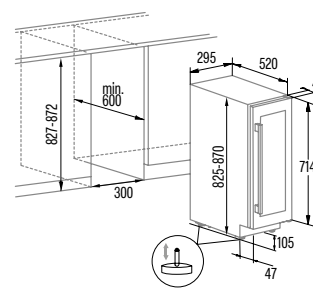

VI 54024 X

Cod.: 07751008 EAN: 8422248101837



- ▶ No frost built-in wine cooler
- ▶ Capacity 28 bottles
- ▶ Temperature between 5/20°C.
- ▶ 2 wooden shelves
- ▶ Electronic temperature control
- ▶ Inner LED light
- ▶ Reversible door
- ▶ Energy class G
- ▶ Sound level 40 dB

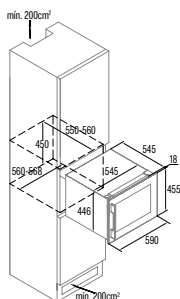

VI 59036 X

Cod.: 07751009 EAN: 8422248371575



- ▶ No frost built-in wine cooler
- ▶ Capacity 36 bottles
- ▶ Dual Temperature zone between 5/22°C
- ▶ 5/13° for white without oak-aging period, sweet, rosé and champagne
- ▶ 13/22° for white with oak-aging, red
- ▶ 3 wooden shelves
- ▶ Electronic temperature control. Inner LED light
- ▶ Reversible door
- ▶ Energy class G
- ▶ Sound level 39dB

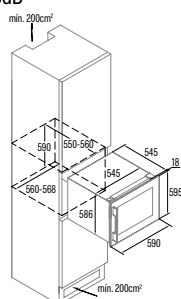

VI 59082 X

Cod.: 07702004 EAN: 8422248098915



- ▶ No frost built-in wine cooler
- ▶ Capacity 46 bottles
- ▶ Dual Temperature zone between 5/22°C
- ▶ 5/13° for white without oak-aging period, sweet, rosé and champagne
- ▶ 13/22° for white with oak-aging, red
- ▶ 5 wooden shelves
- ▶ Electronic temperature control, Inner LED light
- ▶ Reversible door
- ▶ Energy class G
- ▶ Sound level 41dB

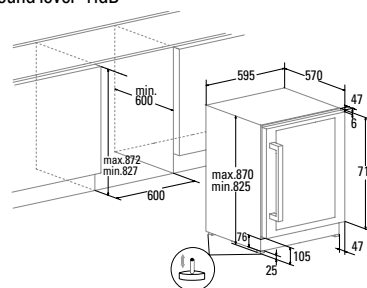

cata & Can Rocca

VI 59082 BK

Cod.: 07701404 EAN: 8422248110785



- ▶ No frost built-in wine cooler
- ▶ Capacity 46 bottles
- ▶ Dual Temperature zone between 5/22°C
- ▶ 5/13° for white without oak-aging period, sweet, rosé and champagne
- ▶ 13/22° for white with oak-aging, red
- ▶ 5 wooden shelves
- ▶ Electronic temperature control, Inner LED light
- ▶ Reversible door. Sound level 41dB
- ▶ Energy class G

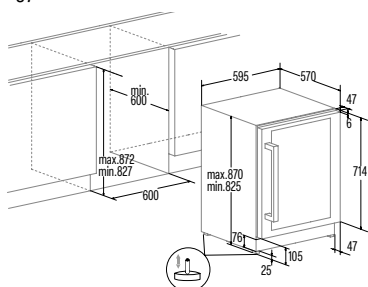

VI 59148 FS BK

Cod.: 07751010 EAN: 8422248371582



- ▶ No frost free standing wine cooler
- ▶ Capacity 65 bottles
- ▶ Dual Temperature zone between 5/22°C
- ▶ 5/13° for white without oak-aging period, sweet, rosé and champagne
- ▶ 13/22° for white with oak-aging, red
- ▶ 6 wooden shelves
- ▶ Electronic temperature control. Inner LED light
- ▶ Carbon filter
- ▶ Reversible door. Sound level 38dB
- ▶ Energy class G

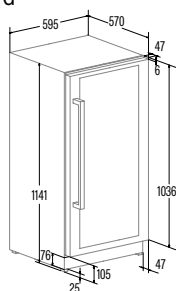

cata & Can Rocca

VI 59177 FS BK

Cod.: 07751011 EAN: 8422248371599



- ▶ No frost free standing wine cooler
- ▶ Capacity 124 bottles
- ▶ Dual Temperature zone between 5/22°C
- ▶ 5/13° for white without oak-aging period, sweet, rosé and champagne
- ▶ 13/22° for white with oak-aging, red
- ▶ 14 wooden shelves
- ▶ Electronic temperature control. Inner LED light
- ▶ Carbon filter
- ▶ Reversible door. Sound level 40dB
- ▶ Energy class G

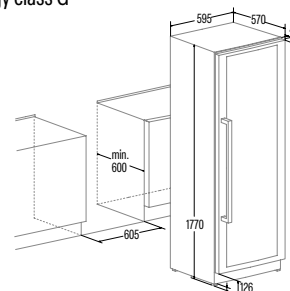



UNDERMOUNT SINKS

CB-2 40-40 R10

Cod.: **02625035** EAN: **8422248370929**

CB 50-40 R10

Cod.: **02625006** EAN: **8422248108652**

CB 45-40 R10

Cod.: **02621006** EAN: **8422248108645**



NEW



- ▶ **10mm radius double square bowl**
- ▶ **Installation in 90-cm unit**
- ▶ Dimensions: 86 x 44 cm
- ▶ **Bowl depth 24cm**
- ▶ **Noise absorber foam**
- ▶ **Anti condensation coating**
- ▶ Stainless steel AISI 304 18/8
- ▶ Hidden basket valve 3 1/2"
- ▶ Thickness 1,2mm

- ▶ **Square bowl**
- ▶ **Installation in 60-cm unit**
- ▶ **Bowl depth 20cm**
- ▶ **Noise absorber foam**
- ▶ **Anti condensation coating**
- ▶ Stainless steel AISI 304 18/10
- ▶ Basket valve 3 1/2"
- ▶ Thickness 1,2mm

- ▶ **Square bowl**
- ▶ **Installation in 60-cm unit**
- ▶ **Bowl depth 20cm**
- ▶ **Noise absorber foam**
- ▶ **Anti condensation coating**
- ▶ Stainless steel AISI 304 18/10
- ▶ Basket valve 3 1/2"
- ▶ Thickness 1,2mm

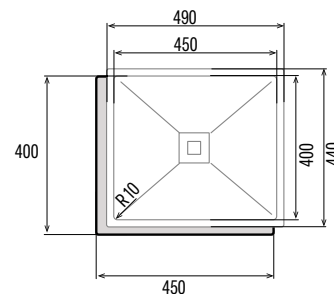
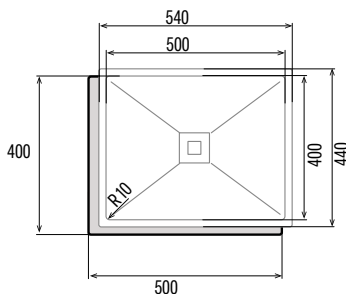
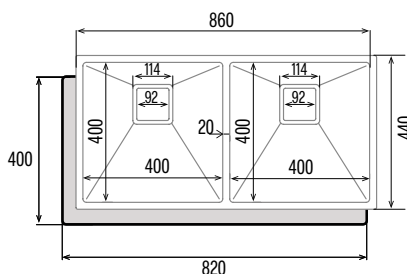

CB 40-40 P R10

Cod.: **02624006** EAN: **8422248108669**

CB 40-40 R10

Cod.: **02624016** EAN: **8422248108638**



- ▶ **Square bowl**
- ▶ **Installation in 50-cm unit**
- ▶ Bowl depth 25cm
- ▶ **Noise absorber foam**
- ▶ **Anti condensation coating**
- ▶ Stainless steel AISI 304 18/10
- ▶ Basket valve 3 1/2"
- ▶ Thickness 1,2mm

- ▶ **Square bowl**
- ▶ **Installation in 50-cm unit**
- ▶ Bowl depth 20cm
- ▶ **Noise absorber foam**
- ▶ **Anti condensation coating**
- ▶ Stainless steel AISI 304 18/10
- ▶ Basket valve 3 1/2"
- ▶ Thickness 1,2mm

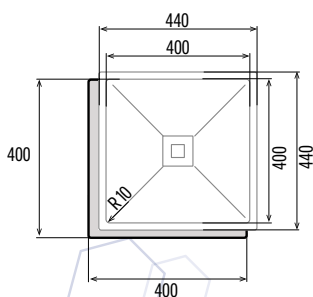
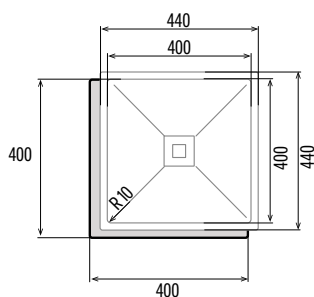

CB 18-40 R15

Cod.: 02625007

EAN: 8422248369565

CB-2

Cod.: 02625008

EAN: 8422248369572

CB 50-40

Cod.: 02625014

EAN: 8422248373043



NEW



NEW



NEW

- ▶ 15mm radius square bowl
- ▶ Installation in 30-cm unit
- ▶ Dimensions: 22 x 44 cm
- ▶ Bowl depth 15cm
- ▶ Noise absorber foam
- ▶ Stainless steel AISI 304 18/8
- ▶ Basket valve 3 1/2"
- ▶ Thickness 1mm

- ▶ Double square bowl
- ▶ Installation in 90-cm unit
- ▶ Dimensions: 79 x 46 cm
- ▶ Bowl depth 20cm
- ▶ Noise absorber foam
- ▶ Stainless steel AISI 304 18/8
- ▶ Basket valve 3 1/2"
- ▶ Thickness 0,9mm

- ▶ Square bowl
- ▶ Installation in 60-cm unit
- ▶ Dimensions: 54,5 x 44,5 cm
- ▶ Bowl depth 18cm
- ▶ Noise absorber foam
- ▶ Stainless steel AISI 304 18/8
- ▶ Basket valve 3 1/2"
- ▶ Thickness 0,8mm

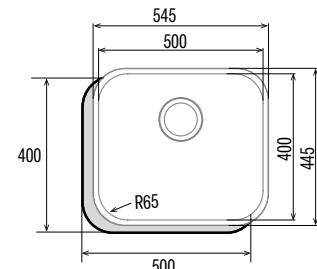
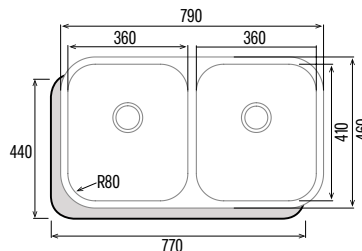
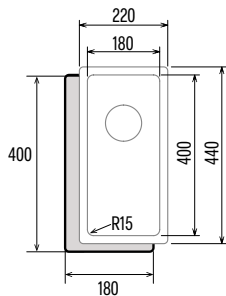

CBP 50-40

Cod.: 02625009

EAN: 8422248369589

CB 45-40

Cod.: 02625010

EAN: 8422248369596

CBP 45-40

Cod.: 02625011

EAN: 8422248369602



NEW



NEW



NEW

- ▶ Square bowl
- ▶ Installation in 60-cm unit
- ▶ Dimensions: 54,5 x 44,5 cm
- ▶ Bowl depth 20cm
- ▶ Noise absorber foam
- ▶ Stainless steel AISI 304 18/8
- ▶ Basket valve 3 1/2"
- ▶ Thickness 0,8mm

- ▶ Square bowl
- ▶ Installation in 60-cm unit
- ▶ Dimensions: 49,5 x 44,5 cm
- ▶ Bowl depth 18cm
- ▶ Noise absorber foam
- ▶ Stainless steel AISI 304 18/8
- ▶ Basket valve 3 1/2"
- ▶ Thickness 0,8mm

- ▶ Square bowl
- ▶ Installation in 60-cm unit
- ▶ Dimensions: 49,5 x 44,5 cm
- ▶ Bowl depth 20cm
- ▶ Noise absorber foam
- ▶ Stainless steel AISI 304 18/8
- ▶ Basket valve 3 1/2"
- ▶ Thickness 0,8mm

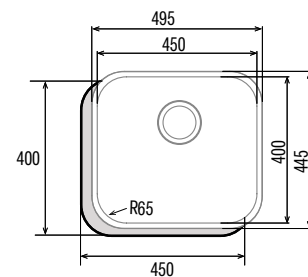
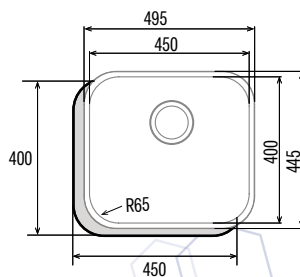
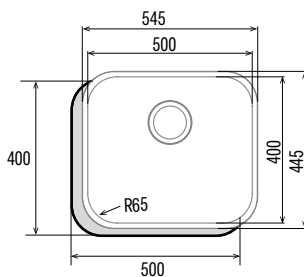

CB 40-40

Cod.: 02625012 EAN: 8422248369619



NEW

- ▶ Square bowl
- ▶ Installation in 50-cm unit
- ▶ Dimensions: 44,5 x 44,5 cm
- ▶ Bowl depth 18cm
- ▶ Noise absorber foam
- ▶ Stainless steel AISI 304
- ▶ Basket valve 3 1/2"
- ▶ Thickness 0,8mm

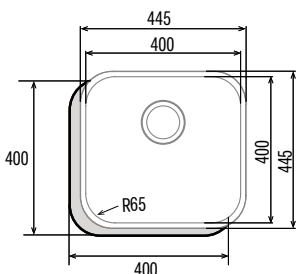

CBP 40-40

Cod.: 02625013 EAN: 8422248369671



NEW

- ▶ Square bowl
- ▶ Installation in 50-cm unit
- ▶ Dimensions: 44,5 x 44,5 cm
- ▶ Bowl depth 20cm
- ▶ Noise absorber foam
- ▶ Stainless steel AISI 304
- ▶ Basket valve 3 1/2"
- ▶ Thickness 0,8mm

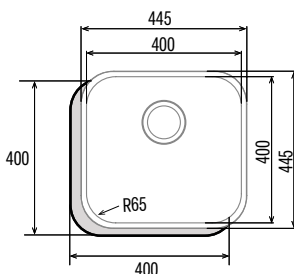

CDC 75-40 SBK

Cod.: 02625037 EAN: 8422248371117



NEW

- ▶ Square bowl
- ▶ Installation in 80-cm unit
- ▶ Dimensions: 75 x 45 cm
- ▶ Bowl depth 20cm
- ▶ Waterfall curtain
- ▶ Faucet, glasswasher, soap dispenser, cutting board and multifunctional drainer included
- ▶ Stainless steel AISI 304
- ▶ Basket valve 3 1/2"
- ▶ Thickness 3-0,8mm

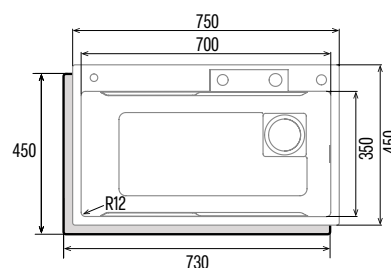

CBS-1 40-40 D R10

Cod.: 02624008 EAN: 8422248109024



- ▶ 1 square bowl with draining board
- ▶ Installation in 45-cm unit
- ▶ Bowl depth 20cm
- ▶ Dimensions: 86 x 51 cm
- ▶ Noise absorber foam
- ▶ Anti condensation coating
- ▶ Stainless steel AISI 304
- ▶ Basket valve 3 1/2"
- ▶ Thickness 1,2mm

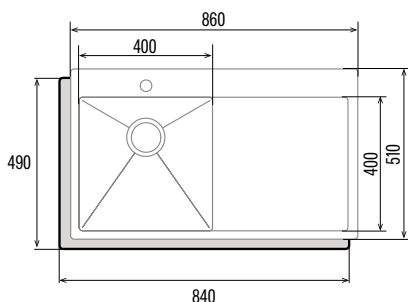

CBS-2 40-40 R10

Cod.: 02624009 EAN: 8422248109031



- ▶ Double square bowl
- ▶ Installation in 90-cm unit
- ▶ Bowl depth 20cm
- ▶ Dimensions: 86 x 51 cm
- ▶ Noise absorber foam
- ▶ Anti condensation coating
- ▶ Stainless steel AISI 304
- ▶ Basket valve 3 1/2"
- ▶ Thickness 1,2mm

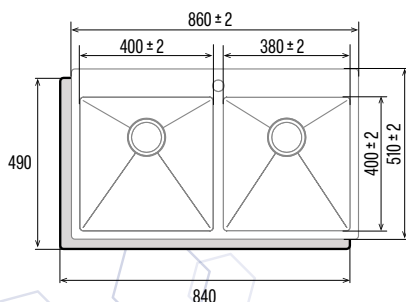

CBS-1 54-40 R10

Cod.: 02624010 EAN: 8422248109048



- ▶ Square bowl
- ▶ Installation in 60-cm unit
- ▶ Bowl depth 20cm
- ▶ Dimensions: 59 x 51 cm
- ▶ Noise absorber foam
- ▶ Anti condensation coating
- ▶ Stainless steel AISI 304
- ▶ Basket valve 3 1/2"
- ▶ Thickness 1,2mm

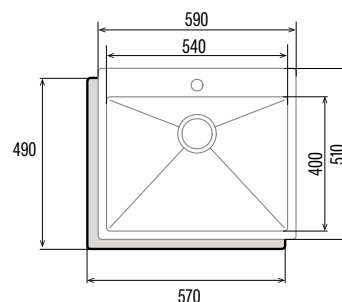

CDL-1 REV

Cod.: **02625002** EAN: **8422248369688**



NEW

- ▶ **1 square bowl with reversible drainer**
- ▶ **Installation in 45-cm unit**
- ▶ Dimensions: 79 x 50 cm
- ▶ **Bowl depth 18cm**
- ▶ **Noise absorber foam**
- ▶ Stainless steel AISI 304 18/8
- ▶ Basket valve 3 1/2"
- ▶ Thickness 0,8mm

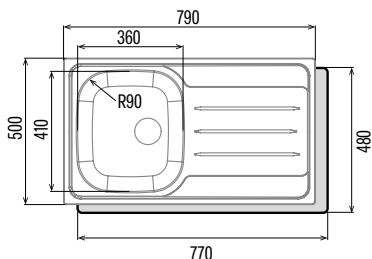

CDL-1 EI

Cod.: **02625015** EAN: **8422248369695**



NEW

- ▶ **1 square bowl with draining board**
- ▶ **Installation in 45-cm unit**
- ▶ Dimensions: 79 x 50 cm
- ▶ **Bowl depth 18cm**
- ▶ **Noise absorber foam**
- ▶ Stainless steel AISI 304 18/8
- ▶ Basket valve 3 1/2"
- ▶ Thickness 0,8mm

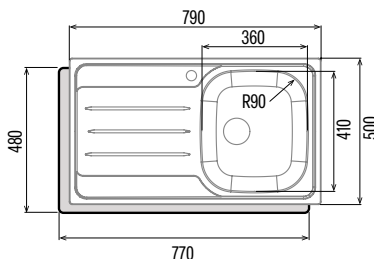

CDL-1 ED

Cod.: **02625016** EAN: **8422248369701**



NEW

- ▶ **1 square bowl with draining board**
- ▶ **Installation in 45-cm unit**
- ▶ Dimensions: 79 x 50 cm
- ▶ **Bowl depth 18cm**
- ▶ **Noise absorber foam**
- ▶ Stainless steel AISI 304 18/8
- ▶ Basket valve 3 1/2"
- ▶ Thickness 0,8mm

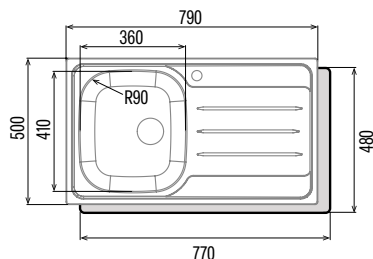

CDP-1 REV

Cod.: **02625017** EAN: **8422248369718**



NEW

- ▶ **1 square bowl with reversible drainer**
- ▶ **Installation in 45-cm unit**
- ▶ Dimensions: 86 x 50 cm
- ▶ **Bowl depth 18cm**
- ▶ **Noise absorber foam**
- ▶ Stainless steel AISI 304 18/10
- ▶ Basket valve 3 1/2"
- ▶ Thickness 0,8mm

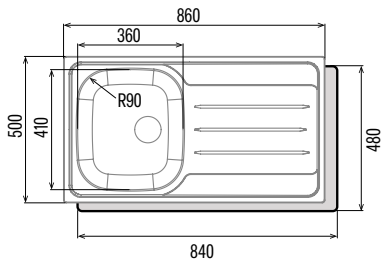

CDP-1 EI

Cod.: **02625018** EAN: **8422248369725**



NEW

- ▶ **1 square bowl with draining board**
- ▶ **Installation in 45-cm unit**
- ▶ Dimensions: 86 x 50 cm
- ▶ **Bowl depth 18cm**
- ▶ **Noise absorber foam**
- ▶ Stainless steel AISI 304 18/10
- ▶ Basket valve 3 1/2"
- ▶ Thickness 0,8mm

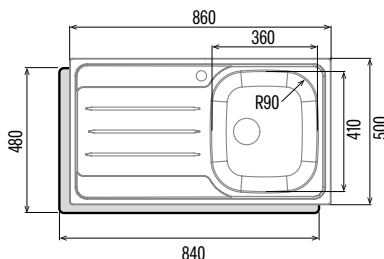

CDP-1 ED

Cod.: **02625019** EAN: **8422248369732**



NEW

- ▶ **1 square bowl with draining board**
- ▶ **Installation in 45-cm unit**
- ▶ Dimensions: 86 x 50 cm
- ▶ **Bowl depth 18cm**
- ▶ **Noise absorber foam**
- ▶ Stainless steel AISI 304 18/10
- ▶ Basket valve 3 1/2"
- ▶ Thickness 0,8mm

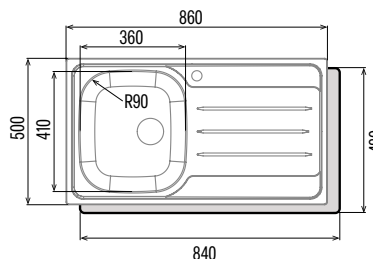

CDS-1 REV

Cod.: **02625021** EAN: **8422248369763**



NEW

- ▶ **1 square bowl with reversible drainer**
- ▶ **Installation in 45-cm unit**
- ▶ Dimensions: 76 x 43,5 cm
- ▶ **Bowl depth 15cm**
- ▶ **Noise absorber foam**
- ▶ Stainless steel AISI 304 18/10
- ▶ Basket valve 3 1/2"
- ▶ Thickness 0,5mm

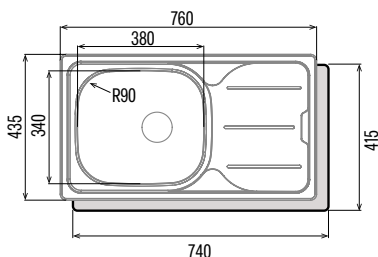

CDS-1 EI

Cod.: **02625022** EAN: **8422248369770**



NEW

- ▶ **1 square bowl with draining board**
- ▶ **Installation in 45-cm unit**
- ▶ Dimensions: 76 x 43,5 cm
- ▶ **Bowl depth 15cm**
- ▶ **Noise absorber foam**
- ▶ Stainless steel AISI 304 18/10
- ▶ Basket valve 3 1/2"
- ▶ Thickness 0,5mm

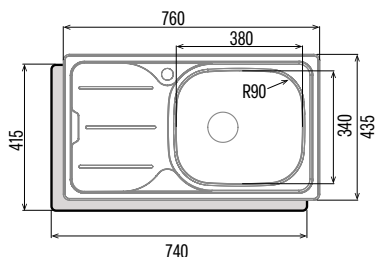

CDS-1 ED

Cod.: **02625023** EAN: **8422248369787**



NEW

- ▶ **1 square bowl with draining board**
- ▶ **Installation in 45-cm unit**
- ▶ Dimensions: 76 x 43,5 cm
- ▶ **Bowl depth 15cm**
- ▶ **Noise absorber foam**
- ▶ Stainless steel AISI 304 18/10
- ▶ Basket valve 3 1/2"
- ▶ Thickness 0,5mm

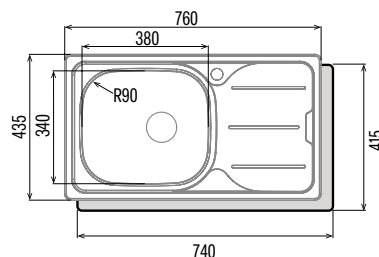

C-2 AG

Cod.: **02625024** EAN: **8422248369800**



NEW

- ▶ **2 square bowl**
- ▶ **Installation in 80-cm unit**
- ▶ Dimensions: 79 x 50 cm
- ▶ **Bowl depth 20cm**
- ▶ **Noise absorber foam**
- ▶ Stainless steel AISI 304 18/8
- ▶ Basket valve 3 1/2"
- ▶ Thickness 0,8mm

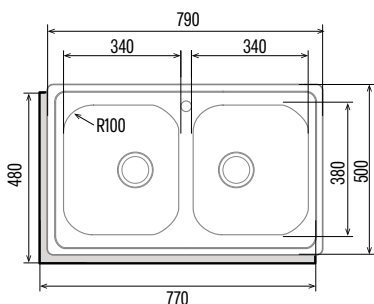

CSS60-1

Cod.: **02625026** EAN: **8422248369824**



NEW

- ▶ **Square bowl**
- ▶ **Installation in 60-cm unit**
- ▶ **Bowl depth 23cm**
- ▶ **Noise absorber foam**
- ▶ Stainless steel AISI 304 18/8
- ▶ Basket valve 3 1/2"
- ▶ Thickness 0,7mm

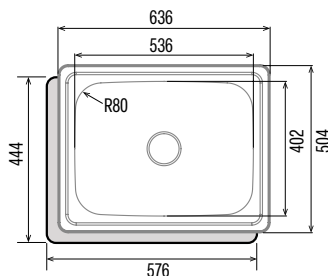

CSS-1

Cod.: **02625027** EAN: **8422248369831**



NEW

- ▶ **Square bowl**
- ▶ **Installation in 50-cm unit**
- ▶ Dimensions: 50 x 40 cm
- ▶ **Bowl depth 15cm**
- ▶ **Noise absorber foam**
- ▶ Stainless steel AISI 304 18/8
- ▶ Basket valve 3 1/2"
- ▶ Thickness 0,6mm

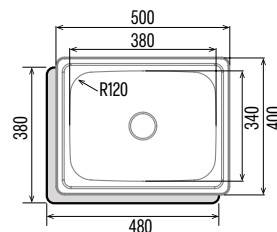

CS-1

Cod.: 02625038 EAN: 8422248371131



NEW

- ▶ Square bowl
- ▶ Installation in 45-cm unit
- ▶ Dimensions: 48 x 48 cm
- ▶ Bowl depth 16,5cm
- ▶ Noise absorber foam
- ▶ Stainless steel AISI 304 18/8
- ▶ Basket valve 3 1/2"
- ▶ Thickness 0,8mm

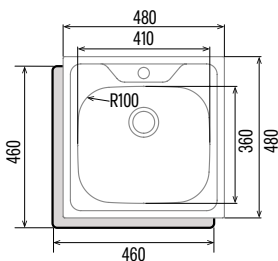

RS-1

Cod.: 02602100 EAN: 8422248108997



- ▶ Round bowl
- ▶ Installation in 45-cm unit
- ▶ Dimensions: Ø48,5 cm
- ▶ Bowl depth 16cm
- ▶ Noise absorber foam
- ▶ Stainless steel AISI 304 18/8
- ▶ Basket valve 3 1/2"
- ▶ Thickness 0,7mm

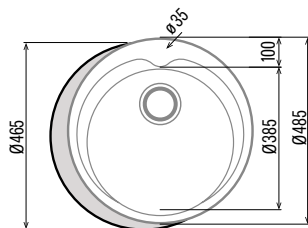

TAPS

CPB

Cod.: 02506401 EAN: 8422248371896



NEW

- ▶ Brass tap
- ▶ Ceramic cartridge
- ▶ Cold start
- ▶ Removable stem, Revolving stem 360°
- ▶ Anti scale areator with 5/min flow limit
- ▶ Chrome finish
- ▶ Shower function
- ▶ Stabiliser triangle
- ▶ M10x1x3/8" certified flexible inlet pipes

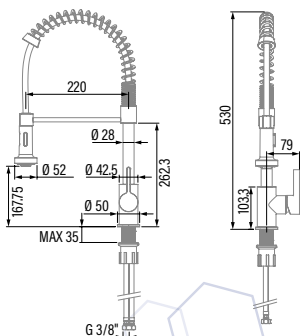

XPB

Cod.: 02506301 EAN: 8422248371902



NEW

- ▶ Stainless Steel tap
- ▶ Ceramic cartridge
- ▶ Cold start
- ▶ Removable stem, Revolving stem 360°
- ▶ Anti scale areator with 5/min flow limit
- ▶ Satin finish
- ▶ Shower function
- ▶ Stabiliser triangle
- ▶ M10x1x3/8" certified flexible inlet pipes

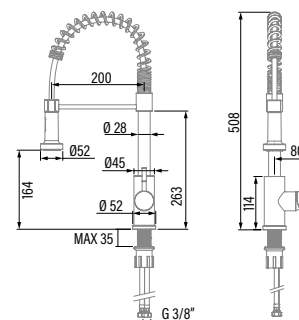

NPB

Cod.: 02500404 EAN: 8422248375740



NEW

- ▶ Stainless Steel tap
- ▶ **Ceramic cartridge**
- ▶ **Cold start**
- ▶ Removable stem, Revolving stem 360°
- ▶ **Anti scale areator with 5/min flow limit**
- ▶ Satin finish
- ▶ Shower function
- ▶ Stabiliser triangle
- ▶ M10x1x3/8" certified flexible inlet pipes

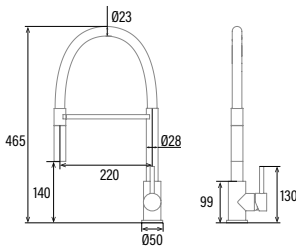

CAB

Cod.: 02500602 EAN: 8422248361989



NEW

- ▶ Window-Facing brass mixer tap
- ▶ **Ceramic cartridge**
- ▶ **Cold start**
- ▶ Revolving stem 360°
- ▶ **Anti scale areator with 5/min flow limit**
- ▶ Chrome finish
- ▶ M10x1x3/8" certified flexible inlet pipes

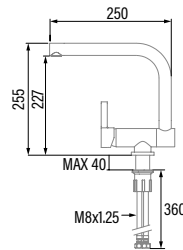

XSE

Cod.: 02500302 EAN: 8422248371919



NEW

- ▶ Stainless Steel tap
- ▶ **Ceramic cartridge**
- ▶ **Cold start**
- ▶ Removable stem, Revolving stem 360°
- ▶ **Anti scale areator with 5/min flow limit**
- ▶ Satin finish
- ▶ Shower function
- ▶ Stabiliser triangle
- ▶ M10x1x3/8" certified flexible inlet pipes

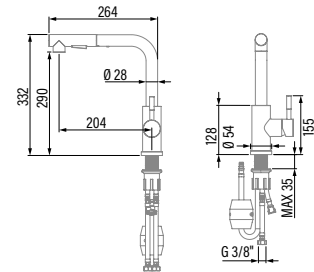

CSE

Cod.: 02500402 EAN: 8422248371926



NEW

- ▶ Brass tap
- ▶ **Ceramic cartridge**
- ▶ **Cold start**
- ▶ Removable stem, Revolving stem 360°
- ▶ **Anti scale areator with 5/min flow limit**
- ▶ Chrome finish
- ▶ Shower function
- ▶ Stabiliser triangle
- ▶ M10x1x3/8" certified flexible inlet pipes

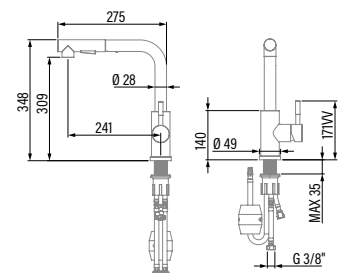

BSE

Cod.: 02500601 EAN: 8422248355308



- ▶ Brass tap
- ▶ **Ceramic cartridge**
- ▶ **Cold start**
- ▶ Removable stem
- ▶ Revolving stem 360°
- ▶ **Anti scale areator with 5.17 l/min flow limit**
- ▶ Black finish

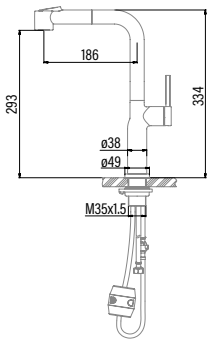

CSA

Cod.: 02500403 EAN: 8422248371933



NEW

- ▶ Brass tap
- ▶ **Ceramic cartridge**
- ▶ **Cold start**
- ▶ Revolving stem 360°
- ▶ **Anti scale areator with 5/min flow limit**
- ▶ Chrome finish
- ▶ Stabiliser triangle
- ▶ M10x1x3/8" certified flexible inlet pipes

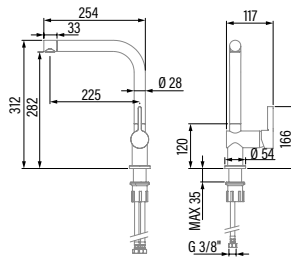

CMA

Cod.: 02503401 EAN: 8422248371957



NEW

- ▶ Brass tap
- ▶ **Ceramic cartridge**
- ▶ **Cold start**
- ▶ Revolving stem 360°
- ▶ **Anti scale areator with 5/min flow limit**
- ▶ Chrome finish
- ▶ Stabiliser triangle
- ▶ M10x1x3/8" certified flexible inlet pipes

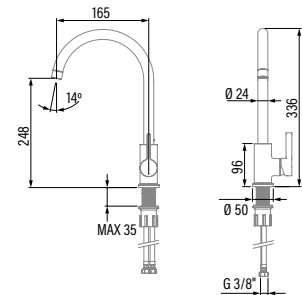

CMA INOX

Cod.: 02503402 EAN: 8422248373241



NEW

- ▶ Stainless Steel tap
- ▶ **Ceramic cartridge**
- ▶ **Cold start**
- ▶ Revolving stem 360°
- ▶ **Anti scale areator with 5/min flow limit**
- ▶ Satin finish
- ▶ Stabiliser triangle
- ▶ M10x1x3/8" certified flexible inlet pipes

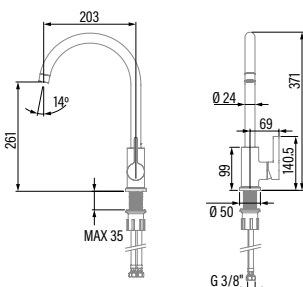

CBA

Cod.: 02502401 EAN: 8422248371964



NEW

- ▶ Brass tap
- ▶ **Ceramic cartridge**
- ▶ **Cold start**
- ▶ Revolving stem 360°
- ▶ **Anti scale areator with 5/min flow limit**
- ▶ Chrome finish
- ▶ Stabiliser triangle
- ▶ M10x1x3/8" certified flexible inlet pipes

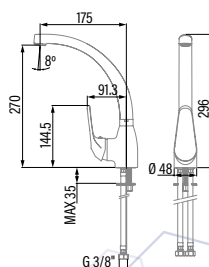

CBB

Cod.: 02501402 EAN: 8422248371971



NEW

- ▶ Brass tap
- ▶ **Ceramic cartridge**
- ▶ **Cold start**
- ▶ Revolving stem 360°
- ▶ **Anti scale areator with 5/min flow limit**
- ▶ Chrome finish
- ▶ Stabiliser triangle
- ▶ M10x1x3/8" certified flexible inlet pipes

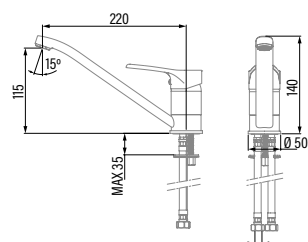





TECHNICAL INFORMATION & ACCESSORIES

Code	02159420	02189020	08000200	08000405	08000206	08000406	02119207	02119203
EAN	8422248343077	8422248344692	8422248358699	8422248109406	8422248358705	8422248198554	8422248069342	8422248062084
Model	RENOVA PURE AIR VN90 BK	RENOVA PURE AIR MNV90 GWH	IAS 7024 220-240V 50-60Hz	AS 750	IAS 6024 220-240V 50-60Hz	AS 600	MAGRABA ISLAND	MOON ISLAND
Type	Vertical	Box	Surface	Surface	Surface	Surface	Island	Island
Product fiche according to directives EU65/2014 - EN61591, EN60704-2-13, EN50564								
AEC (Annual Energy consumption) (kWh/annum)	-	-	43,4	29	43,3	29	97,1	97,1
EEL class (Energy Efficiency Class)	-	-	A+	A	A+	A+	C	C
FDE (Fluid Dynamic Efficiency)	-	-	35,4	27,2	34,9	32	15,7	15,9
FDE class (Fluid Dynamic Efficiency Class)	-	-	A	B	A	A	D	D
LE (Lighting Efficiency) (lux/W)	-	-	-	-	-	-	14,3	14,3
LE class (Lighting Efficiency Class)	-	-	-	-	-	-	D	D
GFE (Grease Filtering Efficiency)	-	-	65,9	45,8	66,8	45,8	91,2	91,2
GFE Class (Grease Filtering Efficiency class)	-	-	D	F	D	F	B	B
Air flow at minimum speed (m³/h)	-	-	325,6	200	318,5	246,4	300	300
Air flow at maximum speed (m³/h)	-	-	535	440,1	525	446,3	645	645
Air flow at intensive speed (TURBO) (m³/h)	-	-	691,5	580	673,2	531,5	-	-
Sound Power Level at minimum speed (dB)	-	-	50	45	50	45	48	48
Sound Power Level at maximum speed (dB)	-	-	68	64	68	64	63	63
Sound Power Level at intensive speed (TURBO) (dB)	-	-	74	67	74	67	-	-
Po (Power Consumption in off mode) (W)	-	-	0,48	0,46	0,48	0,4	0,26	0,45
Ps (Power Consumption in standby) (W)	-	-	-	-	-	-	0	0
Integration directive EU 66/2014								
f (Time Increase Factor)	-	-	0,7	1	0,7	1	1,4	1,4
EEL (Energy Efficiency Index)	-	-	40	49,2	39,9	49,2	84,1	84,1
Q _{BEP} (Flow Rate at Best Efficiency Point) (m³/h)	-	-	379,8	264,2	331,3	264,2	385,1	386,4
P _{BEP} (Static Pressure Difference at Best Efficiency Point) (Pa)	-	-	570	294	644	294	253	254
W _{BEP} (Electric Power Input at Best Efficiency Point) (W)	-	-	169,7	79,4	169,6	79,4	172,1	171,5
W _i (Nominal Power Consumption of Lighting system) (W)	-	-	-	-	-	0	10,5	10,5
E _{MIDDLE} (Average Illumination of Lighting system on Cooking surface) (lux)	-	-	-	-	-	0	150	150
External Dimensions								
Width (mm)	900	900	770	770	590	590	650	400
Depth (mm)	314	310-350	520	520	520	520	650	400
Total max height(mm)	1170	670	170	250	170	275	1700	1700
Total min height(mm)	855	520	170	-	170	-	720	860
Outlet Diameter (mm)	-	-	220x90	150	220x90	150	-	-
Characteristics								
Motor	BT4DC	BT4DC	SL1 BLDC	BLDC	SL1 BLDC	BLDC	BT2	BT2
Extraction Levels	5 + 1	5 + 1	5+1	5+1	5+1	5+1	3	3
Maximum Power Consumption	140	140	165	135	165	135	200	200
Maximum Pressure	357	357	650	-	640	-	400	400
Intensive Speed (TURBO) Pressure	365	365	900	-	870	-	-	-
Control Type	TCD6i	TCD6i	Slider	TC	Slider	TC	VL3	TC3V
Connectivity	AUTO 2	AUTO 2	-	-	-	-	-	-
Automatic removal	√	√	-	-	-	-	-	-
Automatic shut-down timer	√	√	√	√	√	√	√	√
Electronic Filter Saturation Indicator	√	√	√	√	√	√	-	√
Filter Type/ layers	Metallic/Plasma	Metallic/Plasma	Full Black Aluminium Metallic + plastic basket	Metallic	Full Black Aluminium Metallic + plastic basket	Metallic	Metallic	Dual
Anti-grease Filter Number	2+1	3	1	2	1	2	1	1
Inner Shield	-	-	√	√	√	√	-	-
Glass damped open/closure	Pneumatic opening	-	-	-	-	-	-	-
Air purification function	√	√	-	-	-	-	-	-
Air quality sensor	√	√	-	-	-	-	-	-
Anti-drip system	tray	-	-	-	-	-	-	-
Lighting								
Light Type	SS Led	SS Led	-	-	-	-	EcoLed	EcoLed
Adjustable Intensity Lighting	√	√	-	-	-	-	-	√
Colour temperature	Warm 2700°K / White 4000°K	Warm 2700°K / White 4000°K	-	-	-	-	-	-
N° of Lamps	1	1	-	-	-	-	3	3
Installation								
Minimum height distance to a electric worktop hob (mm)	400	550	-	-	-	-	650	650
Minimum height distance to a gas worktop hob (mm)	650	650	-	-	-	-	650	650
Installation with Outlet tube to the exterior / Recirculating	BOTH	BOTH	BOTH	BOTH	BOTH	BOTH	RECIRCULATION	RECIRCULATION
Easy Installation System	√	√	√	√	√	√	√	√
Electric Connection								
Total Rush Power (W)	158	158	7200	7335	7200	7335	210,5	210,5
Rated Voltage (V)	220-240	220-240	220-240	220-240	220/240	220-240	220-240	220-240
Network Frequency (Hz)	50-60	50-60	50-60	50-60	50/60	50-60	50	50
Electrical Insulation Class	CLASS I	CLASS I	CLASS I	CLASS I	CLASS I	CLASS I	CLASS II	CLASS II
Plug	-	-	-	-	-	-	-	-
Accessories / ○ NOT INCLUDED ● INCLUDED								
Upper Decorative tube Extension	-	-	-	-	-	-	-	-
White Decorative Tube	-	-	-	-	-	-	-	-
Black Decorative Tube	-	-	-	-	-	-	-	-
Island Tube Enhancer	-	-	-	-	-	-	-	-
Check Valve	-	-	-	-	-	-	-	-
MAX PRO Metal Filter	-	-	-	-	-	-	-	-
Metal Filter	02800209 +02800927 / ●	02811006 / ●	-	-	02800935* / ●	-	02800935* / ●	-
DUAL Filter (metal + active charcoal)	-	-	-	-	02800937 / ○	-	02800937 / ○	02800922* / ○
Active Charcoal Filter	-	-	-	-	02800939 / ○	-	02801000 / ○	-
Noiseless Flexible Duct	-	-	-	-	02893002 / ○	-	02893002 / ○	-
Top outlet motor cover	-	-	-	-	-	-	-	-
FCA kit without duct cover	-	-	-	-	-	-	-	-

02119101	02119401	02111308	02111309	02111002	02111001	02111305	02097202	02197313	02025205	02119311	02169304
8422248074230	8422248370837	8422248110891	8422248112642	8422248097437	8422248077750	8422248077798	8422248061681	8422248062121	8422248077736	8422248077743	8422248355575
FARO X ISLAND	FARO BK ISLAND	BENNU SLIM 900 X ISLAND	BENNU SLIM 1200 X ISLAND	SIRIN GLASS 1000 GWH ISLAND	SIRIN 1000 WH ISLAND	Fenix 1000 X / A ISLAND	LEGEND 900 XGBK ISLAND	SYGMA 900 X / E ISLAND	GAMMA 900 X / D ISLAND	Vega X / C ISLAND	GALA 900 L
Island	Island	Island	Island	Island	Island	Island	Island	Island	Island	Island	Corner wall chimney
56,3	61,3	24	24	58,9	58,9	58,9	26	56,3	55,7	53,6	53,6
A	B	A+	A+	A	A	A	A+	A	A	A	A
30,6	24,3	35,2	35,2	31,5	31,5	31,5	33,1	30,6	30,2	30,6	30,7
A	B	A	A	A	A	A	A	A	A	A	A
36	21,4	27,7	27,7	36,6	36,6	36,6	36	36	36,6	41,2	23,1
A	B	B	B	A	A	A	A	A	A	A	B
91,2	93,5	58,6	58,6	91,2	91,2	91,2	91,2	91,2	91,2	91,2	91,2
B	B	E	E	B	B	B	B	B	B	B	B
340	334,0	266	266	340	340	340	200	340	340	340	340
600	590,3	535	535	600	600	600	645	600	600	600	600
800	706,3	570	570	850	850	850	820	850	800	850	802
50	54	50	50	50	50	50	40	50	50	50	50
65	69	65	65	65	65	65	64	65	65	65	65
67	71	67	67	67	67	67	67	67	67	67	67
0,26	0,26	0,32	0,32	0,3	0,3	0,3	0,41	0,26	0,26	0,32	0,48
0	-	0	0	0	0	0	0	0	0	0	0,48
0,9	1,1	0,7	0,7	0,9	0,9	0,9	0,8	0,9	0,9	0,9	0,9
53,7	63,5	37,4	37,4	54,6	54,6	54,6	44,8	53,7	53	54,6	52,1
416,9	331,7	289	289	350,4	350,4	350,4	344,8	416,9	429,4	421,1	443,1
411	376,0	375	375	380	380	380	244	411	405	416	427,1
155,7	142,5	85,3	85,3	132,8	132,8	132,8	70,8	155,7	159,8	154,1	171
7	6	3	3	14	14	14	7	7	14	14	3
252	128,3	83	83	513	513	513	252	252	513	513	69
400	400	860	1160	1000	1000	1000	900	900	900	600	900
400	400	665	665	600	600	600	610	600	600	480	500
1090	1090	170	170	500	500	500	1040	1040	1190	1185	985
700	700	170	170	285	285	285	790	790	872	785	635
150/125	150/125	220x90 / 150	220x90 / 150	150	150	150	150/125	150/125	150/125	150/125	150/125
BT3	BT5 AC 800	190	190	BT3	BT3	BT3	BTDCA	BT3	BT3	BT3	BT3
2+1	3+1	5+1	5+1	3+1	3+1	3+1	4+1	2+1	2+1	2+1	3+1
280	280	90	90	280	280	280	130	280	280	280	280
450	439,9	636,5	636,5	450	450	450	455	450	450	450	450
470	455,8	692,1	692,1	470	470	470	470	470	470	470	470
VL3i	VL4i	TC6i	TC6i	TC4i	TC4i	TC4i	TC5i	VL3i	VL3i	VL3i	SX4i
-	-	AUTO 2	AUTO 2	-	-	-	-	-	-	-	-
-	-	-	-	-	-	-	-	-	-	-	-
√	√	√	√	√	√	√	√	√	√	√	√
-	-	√	√	√	√	√	√	-	-	-	√
Metallic	Black metallic, 12 layers	Metallic, 5 layers	Metallic, 5 layers	Metallic, 4 layers	Metallic, 4 layers	Metallic, 4 layers	Metallic	Metallic	Metallic	Metallic, 4 layers	Decorative stainless steel
1	1	2	2	3	3	3	4	4	1	2	3
√	√	-	-	-	-	-	-	-	-	-	-
-	-	-	-	√	√	√	-	-	-	-	-
-	-	√	√	-	-	-	-	-	-	-	-
-	-	-	-	-	-	-	-	-	-	-	-
-	-	-	-	-	-	-	-	-	-	-	-
EcoLed	CSLED	SS Led	SS Led	EcoLed	EcoLed	EcoLed	EcoLed	EcoLed	EcoLed	EcoLed	SS Led
-	√	√	√	√	√	√	√	-	-	-	√
-	White 4000°K	Warm 2700°K / White 4000°K	Warm 2700°K / White 4000°K	-	-	-	-	-	-	-	Warm 2700°K / White 4000°K
2	2	1	1	4	4	4	2	2	4	4	1
650	650	550	550	550	550	550	650	650	650	650	650
650	650	660	660	660	660	660	650	650	650	650	650
BOTH	BOTH	BOTH	BOTH	BOTH	BOTH	BOTH	BOTH	BOTH	BOTH	BOTH	√ / √
√	√	√	√	√	√	√	√	√	√	√	√
287	286	93	93	294	294	294	137	287	294	294	285
220-240	220-240	220-240	220-240	220-240	220-240	220-240	220-240	220-240	220-240	220-240	220-240
50	(220)-50-60/ (240)-50	50	50	50	50	50	50	50	50	50	50
CLASS II	CLASS II	CLASS I	CLASS I	CLASS II	CLASS II	CLASS II	CLASS II	CLASS II	CLASS II	CLASS II	CLASS II
EU - 2 pins	EU - 2 pins	-	-	EU - 2 pins	EU - 2 pins	EU - 2 pins	EU - 2 pins	EU - 2 pins	EU - 2 pins	EU - 2 pins	EU - 2 pins
-	-	-	-	-	-	-	-	-	-	-	-
-	-	-	-	-	-	-	-	-	-	-	-
-	-	-	-	-	-	-	-	-	-	-	-
-	-	-	-	-	-	-	-	-	-	-	-
02832004 / O	02832004 / O	-	-	02832006 / O	02832006 / O	02832006 / O	02832004 / O	02832004 / O	02832004 / O	02832004 / O	02832004 / O
-	-	-	-	02800917 / O	02800917 / O	02800917 / O	02800917 / O	02800917 / O	-	02800917 / O	02800917 / O
02811004* / ●	02801025 / ●	02800930 / ●	02800930 / ●	02800905* / ●	02800905* / ●	02800905* / ●	02800200* / ●	02800200* / ●	02812000* / ●	02800200* / ●	02800206 / ●
02811003* / O	02801030 / O	02800922* / O	02800922* / O	02800918 / O	02800918 / O	02800918 / O	02800918 / O	02800918 / O	-	02800918 / O	02800918 / O
-	-	-	-	02859398 / O	02859398 / O	02859398 / O	02859398 / O	02859398 / O	02859398 / O	02859398 / O	02859398 / O
02893002 / O	02893002 / O	-	-	02893002 / O	02893002 / O	02893002 / O	02893002 / O	02893002 / O	02893002 / O	02893002 / O	02893002 / O
-	02800013 / O	-	-	-	-	-	-	-	-	-	-

Code	02166304	02195309	02195310	02139409	02137409	02139408	02138408	02137408
EAN	8422248355582	8422248077774	8422248077781	8422248356473	8422248356480	8422248356398	8422248356404	8422248356411
Model	GALA 900 R	ANGOLO BOX 1000 X / C	ANGOLO X / D	THALASSA EVO NO DRIP 900 GBK	THALASSA EVO NO DRIP 700 GBK	THALASSA EVO 900 GBK	THALASSA EVO 800 GBK	THALASSA EVO 700 GBK
Type	Corner wall chimney	Corner	Corner	Vertical	Vertical	Vertical	Vertical	Vertical
Product fiche according to directives EU65/2014 - EN61591, EN60704-2-13, EN50564								
AEC (Annual Energy consumption) (kWh/annum)	53,6	56,3	56,3	27,2	27,2	27,2	27,2	27,2
EEL class (Energy Efficiency Class)	A	A	A	A +	A +	A +	A +	A +
FDE (Fluid Dynamic Efficiency)	30,7	30,6	30,6	39,7	39,7	39,7	39,7	39,7
FDE class (Fluid Dynamic Efficiency Class)	A	A	A	A	A	A	A	A
LE (Lighting Efficiency) (lux/W)	23,1	36	36	23,7	23,7	23,7	23,7	23,7
LE class (Lighting Efficiency Class)	B	A	A	B	B	B	B	B
GFE (Grease Filtering Efficiency)	91,2	91,2	91,2	85,3	85,3	85,3	85,3	85,3
GFE Class (Grease Filtering Efficiency class)	B	B	B	B	B	B	B	B
Air flow at minimum speed (m³/h)	340	340	340	205,3	205,3	205,3	205,3	205,3
Air flow at maximum speed (m³/h)	600	600	600	747,5	747,5	747,5	747,5	747,5
Air flow at intensive speed (TURBO) (m³/h)	802	850	850	1007,9	1007,9	1007,9	1007,9	1007,9
Sound Power Level at minimum speed (dB)	50	50	50	45	45	45	45	45
Sound Power Level at maximum speed (dB)	65	65	65	67	67	67	67	67
Sound Power Level at intensive speed (TURBO) (dB)	67	67	67	70	70	70	70	70
Po (Power Consumption in off mode) (W)	0,48	0,26	0,26	0,35	0,35	0,35	0,35	0,35
Ps (Power Consumption in standby) (W)	0,48	0	0	-	-	-	-	-
Integration directive EU 66/2014								
f (Time Increase Factor)	0,9	0,9	0,9	0,6	0,6	0,6	0,6	0,6
EEL (Energy Efficiency Index)	52,1	53,7	53,7	37,8	37,8	37,8	37,8	37,8
Q _{SEP} (Flow Rate at Best Efficiency Point) (m³/h)	444,1	416,9	416,9	377,1	377,1	377,1	377,1	377,1
P _{SEP} (Static Pressure Difference at Best Efficiency Point) (Pa)	427,1	411	411	355,8	355,8	355,8	355,8	355,8
W _{SEP} (Electric Power Input at Best Efficiency Point) (W)	171	155,7	155,7	94	94	94	94	94
W _i (Nominal Power Consumption of Lighting system) (W)	3	7	7	9	9	9	9	9
E _{mean} (Average Illumination of Lighting system on Cooking surface) (lux)	69	252	252	71	71	71	71	71
External Dimensions								
Width (mm)	900	1000	985	895	695	895	795	695
Depth (mm)	500	1000	985	375	375	375	375	375
Total max height (mm)	985	1160	955	1130	1130	1130	1130	1130
Total min height (mm)	635	825	765	815	815	815	815	815
Outlet Diameter (mm)	150/125	150/125	150/125	150/125 up-rear	150/125 up-rear	150/125 up-rear	150/125 up-rear	150/125 up-rear
Characteristics								
Motor	BT3	BT3	BT3	BT5 DC 1000	BT5 DC 1000	BT5 DC 1000	BT5 DC 1000	BT5 DC 1000
Extraction Levels	3+1	2+1	2+1	5+1	5+1	5+1	5+1	5+1
Maximum Power Consumption	280	280	280	250	250	250	250	250
Maximum Pressure	450	450	450	458,2	458,2	458,2	458,2	458,2
Intensive Speed (TURBO) Pressure	470	470	470	469,6	469,6	469,6	469,6	469,6
Control Type	SX4i	VL3i	VL3i	TCD6i	TCD6i	TCD6i	TCD6i	TCD6i
Connectivity	-	-	-	AUTO 2	AUTO 2	AUTO 2	AUTO 2	AUTO 2
Automatic removal	-	-	-	-	-	-	-	-
Automatic shut-down timer	√	√	√	√	√	√	√	√
Electronic Filter Saturation Indicator	√	-	-	√	√	√	√	√
Filter Type/ layers	Decorative stainless steel	Metallic, 4 layers	Metallic, 4 layers	Metallic / HD stainless steel mesh	Metallic / HD stainless steel mesh	Metallic / HD stainless steel mesh	Metallic / HD stainless steel mesh	Metallic / HD stainless steel mesh
Anti-grease Filter Number	3	3	3	1+1	1+1	1+1	1+1	1+1
Inner Shield	-	-	-	-	-	-	-	-
Glass damped open/closure	-	-	-	Pneumatic opening	Pneumatic opening	Pneumatic opening	Pneumatic opening	Pneumatic opening
Air purification function	-	-	-	√	√	√	√	√
Air quality sensor	-	-	-	-	-	-	-	-
Anti-drip system	-	-	-	Removable tray	Removable tray	Removable tray	Removable tray	Removable tray
Lighting								
Light Type	SS Led	EcoLed	EcoLed	SS Led	SS Led	SS Led	SS Led	SS Led
Adjustable Intensity Lighting	√	√	√	√	√	√	√	√
Colour temperature	Warm 2700°K / White 4000°K	Warm 2700°K / White 4000°K	Warm 2700°K / White 4000°K	Warm 2700°K / White 4000°K	Warm 2700°K / White 4000°K	Warm 2700°K / White 4000°K	Warm 2700°K / White 4000°K	Warm 2700°K / White 4000°K
N° of Lamps	1	2	2	1	1	1	1	1
Installation								
Minimum height distance to a electric worktop hob (mm)	650	650	650	450	450	450	450	450
Minimum height distance to a gas worktop hob (mm)	650	650	650	650	650	650	650	650
Installation with Outlet tube to the exterior / Recirculating	√ / √	BOTH	BOTH	BOTH	BOTH	BOTH	BOTH	BOTH
Easy Installation System	√	√	√	√	√	√	√	√
Electric Connection								
Total Rush Power (W)	285	287	287	259	259	259	259	259
Rated Voltage (V)	220-240	220-240	220-240	220-240	220-240	220-240	220-240	220-240
Network Frequency (Hz)	50	50	50	50-60	50-60	50-60	50-60	50-60
Electrical Insulation Class	CLASS II	CLASS II	CLASS II	CLASS II	CLASS II	CLASS II	CLASS II	CLASS II
Plug	EU	EU - 2 pins	EU - 2 pins	-	-	-	-	-
Accessories / ○ NOT INCLUDED ● INCLUDED								
Upper Decorative tube Extension	-	02853300 / ○	-	02861300 / ○	02861300 / ○	02861300 / ○	02861300 / ○	02861300 / ○
White Decorative Tube	-	-	-	02861001 / ○	02861001 / ○	02861001 / ○	02861001 / ○	02861001 / ○
Black Decorative Tube	-	-	-	02861401 / ○	02861401 / ○	02861401 / ○	02861401 / ○	02861401 / ○
Island Tube Enhancer	-	-	-	-	-	-	-	-
Check Valve	02832004 / ○	02832004 / ○	02832004 / ○	02832004 / ○	02832004 / ○	02832004 / ○	02832004 / ○	02832004 / ○
MAX PRO Metal Filter	02800917 / ○	02800917 / ○	-	-	-	-	-	-
Metal Filter	02800206 / ●	02800200 / ●	02800300 / ●	02801004 + 02800925 / ●	02801004 + 02800925 / ●	02801004 + 02800925 / ●	02801004 + 02800925 / ●	02801004 + 02800925 / ●
DUAL Filter (metal + active charcoal)	02800918 / ○	02800918 / ○	-	02800922* / ○	02800922* / ○	02800922* / ○	02800922* / ○	02800922* / ○
Active Charcoal Filter	02859398 / ○	-	02859398 / ○	02859398 / ○	02859398 / ○	02859398 / ○	02859398 / ○	02859398 / ○
Noiseless Flexible Duct	02893002 / ○	02893002 / ○	02893002 / ○	02893002 / ○	02893002 / ○	02893002 / ○	02893002 / ○	02893002 / ○
Top outlet motor cover	-	-	-	02800014 / ●	02800014 / ●	02800014 / ●	02800014 / ●	02800014 / ●
FCA kit without duct cover	-	-	-	02800013 / ○	02800013 / ○	02800013 / ○	02800013 / ○	02800013 / ○

02136408	02139008	02138008	02137008	02136008	02131407	02139407	02138407	02137407	02136407	02139007	02138007
8422248356428	8422248356435	8422248356442	8422248356459	8422248356466	8422248356329	8422248356282	8422248356299	8422248356305	8422248356312	8422248356336	8422248356343
THALASSA EVO 600 GBK	THALASSA EVO 900 GWH	THALASSA EVO 800 GWH	THALASSA EVO 700 GWH	THALASSA EVO 600 GWH	THALASSA PRO 1200GBK	THALASSA PRO 900GBK	THALASSA PRO 800GBK	THALASSA PRO 700GBK	THALASSA PRO 600GBK	THALASSA PRO 900GWH	THALASSA PRO 800GWH
Vertical	Vertical	Vertical	Vertical	Vertical	Vertical	Vertical	Vertical	Vertical	Vertical	Vertical	Vertical
27,2	27,2	27,2	27,2	27,2	16,8	16,8	16,8	16,8	16,8	16,8	16,8
A+	A+	A+	A+	A+	A+++	A+++	A+++	A+++	A+++	A+++	A+++
39,7	39,7	39,7	39,7	39,7	40,3	40,3	40,3	40,3	40,3	40,3	40,3
A	A	A	A	A	A	A	A	A	A	A	A
23,7	23,7	23,7	23,7	23,7	23,7	23,7	23,7	23,7	23,7	23,7	23,7
B	B	B	B	B	B	B	B	B	B	B	B
85,3	85,3	85,3	85,3	85,3	75,5	75,5	75,5	75,5	75,5	75,5	75,5
B	B	B	B	B	C	C	C	C	C	C	C
205,3	205,3	205,3	205,3	205,3	283	283	283	283	283	283	283
747,5	747,5	747,5	747,5	747,5	640,5	640,5	640,5	640,5	640,5	640,5	640,5
1007,9	1007,9	1007,9	1007,9	1007,9	842	842	842	842	842	842	842
45	45	45	45	45	46	46	46	46	46	46	46
67	67	67	67	67	64	64	64	64	64	64	64
70	70	70	70	70	69	69	69	69	69	69	69
0,35	0,35	0,35	0,35	0,35	0,35	0,35	0,35	0,35	0,35	0,35	0,35
-	-	-	-	-	-	-	-	-	-	-	-
0,6	0,6	0,6	0,6	0,6	0,5	0,5	0,5	0,5	0,5	0,5	0,5
37,8	37,8	37,8	37,8	37,8	27,5	27,5	27,5	27,5	27,5	27,5	27,5
377,1	377,1	377,1	377,1	377,1	369,6	369,6	369,6	369,6	369,6	369,6	369,6
355,8	355,8	355,8	355,8	355,8	314	314	314	314	314	314	314
94	94	94	94	94	80	80	80	80	80	80	80
9	9	9	9	9	3	3	3	3	3	3	3
71	71	71	71	71	71	71	71	71	71	71	71
595	895	795	695	595	1195	895	795	695	595	895	795
375	375	375	375	375	375	375	375	375	375	375	375
1130	1130	1130	1130	1130	1130	1130	1130	1130	1130	1130	1130
815	815	815	815	815	815	815	815	815	815	815	815
150/125 up-rear	150/125 up-rear	150/125 up-rear	150/125 up-rear	150/125 up-rear	150/125	150/125	150/125	150/125	150/125	150/125	150/125
BT5 DC 1000	BT5 DC 1000	BT5 DC 1000	BT5 DC 1000	BT5 DC 1000	BT4DC	BT4DC	BT4DC	BT4DC	BT4DC	BT4DC	BT4DC
5+1	5+1	5+1	5+1	5+1	5+1	5+1	5+1	5+1	5+1	5+1	5+1
250	250	250	250	250	135	135	135	135	135	135	135
458,2	458,2	458,2	458,2	458,2	357	357	357	357	357	357	357
469,6	469,6	469,6	469,6	469,6	365	365	365	365	365	365	365
TCDei	TCDei	TCDei	TCDei	TCDei	TCDei	TCDei	TCDei	TCDei	TCDei	TCDei	TCDei
AUTO 2	AUTO 2	AUTO 2	AUTO 2	AUTO 2	AUTO 2	AUTO 2	AUTO 2	AUTO 2	AUTO 2	AUTO 2	AUTO 2
-	-	-	-	-	-	-	-	-	-	-	-
√	√	√	√	√	√	√	√	√	√	√	√
√	√	√	√	√	√	√	√	√	√	√	√
Metallic / HD stainless steel mesh	Metallic / HD stainless steel mesh	Metallic / HD stainless steel mesh	Metallic / HD stainless steel mesh	Metallic / HD stainless steel mesh	Metallic, 5 layers	Metallic, 5 layers	Metallic, 5 layers	Metallic, 5 layers	Metallic, 5 layers	Metallic, 5 layers	Metallic, 5 layers
1+1	1+1	1+1	1+1	1+1	1+1	1+1	1+1	1+1	1+1	1+1	1+1
-	-	-	-	-	-	-	-	-	-	-	-
Pneumatic opening	Pneumatic opening	Pneumatic opening	Pneumatic opening	Pneumatic opening	Pneumatic opening	Pneumatic opening	Pneumatic opening	Pneumatic opening	Pneumatic opening	Pneumatic opening	Pneumatic opening
√	√	√	√	√	√	√	√	√	√	√	√
-	-	-	-	-	-	-	-	-	-	-	-
Removable tray	Removable tray	Removable tray	Removable tray	Removable tray	tray	tray	tray	tray	tray	tray	tray
SS Led	SS Led	SS Led	SS Led	SS Led	SS Led	SS Led	SS Led	SS Led	SS Led	SS Led	SS Led
√	√	√	√	√	√	√	√	√	√	√	√
Warm 2700°K / White 4000°K	Warm 2700°K / White 4000°K	Warm 2700°K / White 4000°K	Warm 2700°K / White 4000°K	Warm 2700°K / White 4000°K	Warm 2700°K / White 4000°K	Warm 2700°K / White 4000°K	Warm 2700°K / White 4000°K	Warm 2700°K / White 4000°K	Warm 2700°K / White 4000°K	Warm 2700°K / White 4000°K	Warm 2700°K / White 4000°K
1	1	1	1	1	1	1	1	1	1	1	1
450	450	450	450	450	450	450	450	450	450	450	450
650	650	650	650	650	650	650	650	650	650	650	650
BOTH	BOTH	BOTH	BOTH	BOTH	BOTH	BOTH	BOTH	BOTH	BOTH	BOTH	BOTH
√	√	√	√	√	√	√	√	√	√	√	√
259	259	259	259	259	138	138	138	138	138	138	138
220-240	220-240	220-240	220-240	220-240	220-240	220-240	220-240	220-240	220-240	220-240	220-240
50-60	50-60	50-60	50-60	50-60	50-60	50-60	50-60	50-60	50-60	50-60	50-60
CLASE II	CLASE II	CLASE II	CLASE II	CLASE II	CLASS I	CLASS I	CLASS I	CLASS I	CLASS I	CLASS I	CLASS I
-	-	-	-	-	-	-	-	-	-	-	-
02861300 / O	02861300 / O	02861300 / O	02861300 / O	02861300 / O	02861300 / O	02861300 / O	02861300 / O	02861300 / O	02861300 / O	02861300 / O	02861300 / O
02861001 / O	02861001 / O	02861001 / O	02861001 / O	02861001 / O	02861001 / O	02861001 / O	02861001 / O	02861001 / O	02861001 / O	02861001 / O	02861001 / O
02861401 / O	02861401 / O	02861401 / O	02861401 / O	02861401 / O	02861401 / O	02861401 / O	02861401 / O	02861401 / O	02861401 / O	02861401 / O	02861401 / O
-	-	-	-	-	-	-	-	-	-	-	-
02832004 / O	02832004 / O	02832004 / O	02832004 / O	02832004 / O	02832004 / O	02832004 / O	02832004 / O	02832004 / O	02832004 / O	02832004 / O	02832004 / O
-	-	-	-	-	-	-	-	-	-	-	-
02801004 + 02800925 / ●	02801004 + 02800925 / ●	02801004 + 02800925 / ●	02801004 + 02800925 / ●	02801004 + 02800925 / ●	02800930 + 02800925 / ●	02800930 + 02800925 / ●	02800930 + 02800925 / ●	02800930 + 02800925 / ●	02800930 + 02800925 / ●	02800930 + 02800925 / ●	02800930 + 02800925 / ●
02800922* / O	02800922* / O	02800922* / O	02800922* / O	02800922* / O	02800922* / O	02800922* / O	02800922* / O	02800922* / O	02800922* / O	02800922* / O	02800922* / O
02859398 / O	02859398 / O	02859398 / O	02859398 / O	02859398 / O	02859318 / O	02859318 / O	02859318 / O	02859318 / O	02859318 / O	02859318 / O	02859318 / O
02893002 / O	02893002 / O	02893002 / O	02893002 / O	02893002 / O	02893002 / O	02893002 / O	02893002 / O	02893002 / O	02893002 / O	02893002 / O	02893002 / O
02800014 / ●	02800014 / ●	02800014 / ●	02800014 / ●	02800014 / ●	02800014 / O	02800014 / O	02800014 / O	02800014 / O	02800014 / O	02800014 / O	02800014 / O
02800013 / O	02800013 / O	02800013 / O	02800013 / O	02800013 / O	02800013 / O	02800013 / O	02800013 / O	02800013 / O	02800013 / O	02800013 / O	02800013 / O

Code	02137007	02136007	02139507	02138507	02139406	02137406	02136406	02139006
EAN	8422248356350	8422248356367	8422248356374	8422248356381	8422248356220	8422248356237	8422248356244	8422248356251
Model	THALASSA PRO 700GWH	THALASSA PRO 600GWH	THALASSA PRO 900GR	THALASSA PRO 800GR	THALASSA 900GBK	THALASSA 700GBK	THALASSA 600GBK	THALASSA 900GWH
Type	Vertical	Vertical	Vertical	Vertical	Vertical	Vertical	Vertical	Vertical
Product fiche according to directives EU65/2014 - EN61591, EN60704-2-13, EN50564								
AEC (Annual Energy consumption) (kWh/annum)	16,8	16,8	16,8	16,8	58,6	58,6	58,6	58,6
EEL class (Energy Efficiency Class)	A+++	A+++	A+++	A+++	A	A	A	A
FDE (Fluid Dynamic Efficiency)	40,3	40,3	40,3	40,3	29,4	29,4	29,4	29,4
FDE class (Fluid Dynamic Efficiency Class)	A	A	A	A	A	A	A	A
LE (Lighting Efficiency) (lux/W)	23,7	23,7	23,7	23,7	23,7	23,7	23,7	23,7
LE class (Lighting Efficiency Class)	B	B	B	B	B	B	B	B
GFE (Grease Filtering Efficiency)	75,5	75,5	75,5	75,5	75,5	75,5	75,5	75,5
GFE Class (Grease Filtering Efficiency class)	C	C	C	C	C	C	C	C
Air flow at minimum speed (m³/h)	283	283	283	283	346	346	346	346
Air flow at maximum speed (m³/h)	640,5	640,5	640,5	640,5	600	600	600	600
Air flow at intensive speed (TURBO) (m³/h)	842	842	842	842	811	811	811	811
Sound Power Level at minimum speed (dB)	46	46	46	46	50	50	50	50
Sound Power Level at maximum speed (dB)	64	64	64	64	65	65	65	65
Sound Power Level at intensive speed (TURBO) (dB)	69	69	69	69	67	67	67	67
Po (Power Consumption in off mode) (W)	0,35	0,35	0,35	0,35	0,43	0,43	0,43	0,43
Ps (Power Consumption in standby) (W)	-	-	-	-	-	-	-	-
Integration directive EU 66/2014								
f (Time Increase Factor)	0,5	0,5	0,5	0,5	0,9	0,9	0,9	0,9
EEL (Energy Efficiency Index)	27,5	27,5	27,5	27,5	52,7	52,7	52,7	52,7
Q _{best} (Flow Rate at Best Efficiency Point) (m³/h)	369,6	369,6	369,6	369,6	457,2	457,2	457,2	457,2
P _{best} (Static Pressure Difference at Best Efficiency Point) (Pa)	314	314	314	314	397	397	397	397
W _{best} (Electric Power Input at Best Efficiency Point) (W)	80	80	80	80	171,6	171,6	171,6	171,6
W _i (Nominal Power Consumption of Lighting system) (W)	3	3	3	3	3	3	3	3
E _{mean} (Average Illumination of Lighting system on Cooking surface) (lux)	71	71	71	71	71	71	71	71
External Dimensions								
Width (mm)	695	595	895	795	895	695	595	895
Depth (mm)	375	375	375	375	375	375	375	375
Total max height (mm)	1130	1130	1130	1130	1130	1130	1130	1130
Total min height (mm)	815	815	815	815	815	815	815	815
Outlet Diameter (mm)	150/125	150/125	150/125	150/125	150	150	150	150
Characteristics								
Motor	BT4DC	BT4DC	BT4DC	BT4DC	BT3	BT3	BT3	BT3
Extraction Levels	5+1	5+1	5+1	5+1	3+1	3+1	3+1	3+1
Maximum Power Consumption	135	135	135	135	280	280	280	280
Maximum Pressure	357	357	357	357	450	450	450	450
Intensive Speed (TURBO) Pressure	365	365	365	365	470	470	470	470
Control Type	TCD6i	TCD6i	TCD6i	TCD6i	SDX6i	SDX6i	SDX6i	SDX6i
Connectivity	AUTO 2	AUTO 2	AUTO 2	AUTO 2	AUTO 2	AUTO 2	AUTO 2	AUTO 2
Automatic removal	-	-	-	-	-	-	-	-
Automatic shut-down timer	√	√	√	√	√	√	√	√
Electronic Filter Saturation Indicator	√	√	√	√	√	√	√	√
Filter Type/ layers	Metallic, 5 layers	Metallic, 5 layers	Metallic, 5 layers	Metallic, 5 layers	Metallic, 5 layers	Metallic, 5 layers	Metallic, 5 layers	Metallic, 5 layers
Anti-grease Filter Number	1+1	1+1	1+1	1+1	1+1	1+1	1+1	1+1
Inner Shield	-	-	-	-	-	-	-	-
Glass damped open/closure	Pneumatic opening	Pneumatic opening	Pneumatic opening	Pneumatic opening	Pneumatic opening	Pneumatic opening	Pneumatic opening	Pneumatic opening
Air purification function	√	√	√	√	√	√	√	√
Air quality sensor	-	-	-	-	-	-	-	-
Anti-drip system	tray	tray	tray	tray	tray	tray	tray	tray
Lighting								
Light Type	SS Led	SS Led	SS Led	SS Led	SS Led	SS Led	SS Led	SS Led
Adjustable Intensity Lighting	√	√	√	√	√	√	√	√
Colour temperature	Warm 2700°K / White 4000°K	Warm 2700°K / White 4000°K	Warm 2700°K / White 4000°K	Warm 2700°K / White 4000°K	Warm 2700°K / White 4000°K	Warm 2700°K / White 4000°K	Warm 2700°K / White 4000°K	Warm 2700°K / White 4000°K
N° of Lamps	1	1	1	1	1	1	1	1
Installation								
Minimum height distance to a electric worktop hob (mm)	450	450	450	450	450	450	450	450
Minimum height distance to a gas worktop hob (mm)	650	650	650	650	650	650	650	650
Installation with Outlet tube to the exterior / Recirculating	BOTH	BOTH	BOTH	BOTH	BOTH	BOTH	BOTH	BOTH
Easy Installation System	√	√	√	√	√	√	√	√
Electric Connection								
Total Rush Power (W)	138	138	138	138	283	283	283	283
Rated Voltage (V)	220-240	220-240	220-240	220-240	220-240	220-240	220-240	220-240
Network Frequency (Hz)	50-60	50-60	50-60	50-60	50-60	50-60	50-60	50-60
Electrical Insulation Class	CLASS I	CLASS I	CLASS I	CLASS I	CLASS II	CLASS II	CLASS II	CLASS II
Plug	-	-	-	-	-	-	-	-
Accessories / ○ NOT INCLUDED ● INCLUDED								
Upper Decorative tube Extension	02861300 / ○	02861300 / ○	02861300 / ○	02861300 / ○	02861400 / ○	02861400 / ○	02861400 / ○	02861000 / ○
White Decorative Tube	02861001 / ○	02861001 / ○	02861001 / ○	02861001 / ○	02861001 / ○	02861001 / ○	02861001 / ○	02861001 / ○
Black Decorative Tube	02861401 / ○	02861401 / ○	02861401 / ○	02861401 / ○	02861401 / ○	02861401 / ○	02861401 / ○	02861401 / ○
Island Tube Enhancer	-	-	-	-	-	-	-	-
Check Valve	02832004 / ○	02832004 / ○	02832004 / ○	02832004 / ○	02832004 / ○	02832004 / ○	02832004 / ○	02832004 / ○
MAX PRO Metal Filter	-	-	-	-	-	-	-	-
Metal Filter	02800930 + 02800925 / ●	02800930 + 02800925 / ●	02800930 + 02800925 / ●	02800930 + 02800925 / ●	02800930 + 02800925 / ●	02800930 + 02800925 / ●	02800930 + 02800925 / ●	02800930 + 02800925 / ●
DUAL Filter (metal + active charcoal)	02800922* / ○	02800922* / ○	02800922* / ○	02800922* / ○	02800922* / ○	02800922* / ○	02800922* / ○	02800922* / ○
Active Charcoal Filter	02859318 / ○	02859318 / ○	02859318 / ○	02859318 / ○	02859398 / ○	02859398 / ○	02859398 / ○	02859398 / ○
Noiseless Flexible Duct	02893002 / ○	02893002 / ○	02893002 / ○	02893002 / ○	02893002 / ○	02893002 / ○	02893002 / ○	02893002 / ○
Top outlet motor cover	02800014 / ○	02800014 / ○	02800014 / ○	02800014 / ○	02800014 / ○	02800014 / ○	02800014 / ○	02800014 / ○
FCA kit without duct cover	02800013 / ○	02800013 / ○	02800013 / ○	02800013 / ○	02800013 / ○	02800013 / ○	02800013 / ○	02800013 / ○

02137006	02136006	02059701	02078701	02027701	02059801	02078801	02027801	02059700	02078700	02027700	02012610
8422248356268	8422248356275	8422248356643	8422248356636	8422248356629	8422248356674	8422248356667	8422248356650	8422248356612	8422248356605	8422248356599	8422248360395
THALASSA 700GWH	THALASSA 600GWH	JUNO- 9000 GBK	JUNO+ 7000 GBK	JUNO+ 6000 GBK	JUNO- 9000 GWH	JUNO+ 7000 GWH	JUNO+ 6000 GWH	JUNO 9000 GBK	JUNO 7000 GBK	JUNO 6000 GBK	HESTIA 600 GBK
Vertical	Vertical	Vertical	Vertical	Vertical	Vertical	Vertical	Vertical	Vertical	Vertical	Vertical	Vertical
58,6	58,6	20	20	20	20	20	20	16,4	16,4	16,4	31,8
A	A	A+	A+	A+	A+	A+	A+	A+	A+	A+	B
29,4	29,4	32,4	32,4	32,4	32,4	32,4	32,4	25,3	25,3	25,3	19,3
A	A	A	A	A	A	A	A	B	B	B	C
23,7	23,7	28	28	32	28	28	32	89	89	103	82,6
B	B	B	B	A	B	B	A	A	A	A	A
75,5	75,5	72,1	72,1	72,1	72,1	72,1	72,1	65,4	65,4	65,4	62,5
C	C	D	D	D	D	D	D	D	D	D	E
346	346	212,1	212,1	212,1	212,1	212,1	212,1	185,9	185,9	185,9	191,7
600	600	389	389	389	389	389	389	363,2	363,2	363,2	357,7
811	811	548,4	548,4	548,4	548,4	548,4	548,4	424,5	424,5	424,5	-
50	50	50	50	50	50	50	50	45	45	45	51
65	65	64	64	64	64	64	64	61	61	61	67
67	67	71	71	71	71	71	71	63	63	63	-
0,43	0,43	0,48	0,48	0,48	0,48	0,48	0,48	0,48	0,48	0,48	0
-	-	0	0	0	0	0	0	0	0	0	0
0,9	0,9	0,8	0,8	0,8	0,8	0,8	0,8	1,1	1,1	1,1	1,3
52,7	52,7	39,7	39,7	39,7	39,7	39,7	39,7	44,9	44,9	44,9	62,2
457,2	457,2	274,9	274,9	274,9	274,9	274,9	274,9	196,3	196,3	196,3	230,7
397	397	258	258	258	258	258	258	166	166	166	186
171,6	171,6	60,9	60,9	60,9	60,9	60,9	60,9	36,5	36,5	36,5	61,5
3	3	3,5	3,5	3,5	3,5	3,5	3,5	2,8	2,8	2,8	3,5
71	71	98	98	111	98	98	111	250	250	289	289
695	595	900	700	600	900	700	600	900	700	600	598
375	375	400	400	400	400	400	400	370	370	370	340
1130	1130	1000	1000	1000	1000	1000	1000	1000	1000	1000	1055
815	815	820	820	820	820	820	820	820	820	820	825
150	150	150	150	150	150	150	150	150	150	150	120
BT3	BT3	TIDC	TIDC	TIDC	TIDC	TIDC	TIDC	EY450	EY450	EY450	K9C
3+1	3+1	5+1	5+1	5+1	5+1	5+1	5+1	5+1	5+1	5+1	3
280	280	90	90	90	90	90	90	70	70	70	50
450	450	250	250	250	250	250	250	230	230	230	206
470	470	315	315	315	315	315	315	270	270	270	-
SDX6i	SDX6i	TC06i	TC06i	TC06i	TC06i	TC06i	TC06i	TC06i	TC06i	TC06i	Mechanic
AUTO 2	AUTO 2	AUTO 2	AUTO 2	AUTO 2	AUTO 2	AUTO 2	AUTO 2	AUTO 2	AUTO 2	AUTO 2	-
-	-	-	-	-	-	-	-	-	-	-	-
√	√	√	√	√	√	√	√	√	√	√	-
√	√	√	√	√	√	√	√	√	√	√	-
Metallic, 5 layers	Metallic, 5 layers	Metallic	Metallic	Metallic	Metallic	Metallic	Metallic	Metallic	Metallic	Metallic	Metallic
1+1	1+1	1+1	1+1	1+1	1+1	1+1	1+1	1	1	1	1
-	-	-	-	-	-	-	-	-	-	-	-
Pneumatic opening	Pneumatic opening	Pneumatic opening	Pneumatic opening	Pneumatic opening	Pneumatic opening	Pneumatic opening	Pneumatic opening	-	-	-	-
√	√	-	-	-	-	-	-	-	-	-	-
-	-	-	-	-	-	-	-	-	-	-	-
tray	tray	-	-	-	-	-	-	-	-	-	-
SS Led	SS Led	SS Led	SS Led	SS Led	SS Led	SS Led	SS Led	CSLED	CSLED	CSLED	CSLED
√	√	√	√	√	√	√	√	√	√	√	-
Warm 2700°K / White 4000°K	Warm 2700°K / White 4000°K										
1	1	1	1	1	1	1	1	1	1	1	1
450	450	400	400	400	400	400	400	400	400	400	590
650	650	650	650	650	650	650	650	650	650	650	650
BOTH	BOTH	BOTH	BOTH	BOTH	BOTH	BOTH	BOTH	BOTH	BOTH	BOTH	BOTH
√	√	√	√	√	√	√	√	√	√	√	√
283	283	93	93	93	93	93	93	73	73	73	53
220-240	220-240	220-240	220-240	220-240	220-240	220-240	220-240	220-240	220-240	220-240	220-240
50-60	50-60	50/60Hz	50/60Hz	50/60Hz	50/60Hz	50/60Hz	50/60Hz	50/60Hz	50/60Hz	50/60Hz	50/60Hz
CLASS II	CLASS II	CLASS I	CLASS I	CLASS I	CLASS I	CLASS I	CLASS I	CLASS I	CLASS I	CLASS I	CLASS I
-	-	-	-	-	-	-	-	-	-	-	-
02861000 / O	02861000 / O	-	-	-	-	-	-	-	-	-	-
02861001 / O	02861001 / O	-	-	-	-	-	-	-	-	-	-
02861401 / O	02861401 / O	-	-	-	-	-	-	-	-	-	-
-	-	-	-	-	-	-	-	-	-	-	-
02832004 / O	02832004 / O	02832004 / O	02832004 / O	02832004 / O	02832004 / O	02832004 / O	02832004 / O	-	-	-	-
-	-	-	-	-	-	-	-	-	-	-	-
02800930 + 02800925 / ●	02800930 + 02800925 / ●	02800915 + 02800949 / ●	02800915 + 02800949 / ●	02800915 + 02800949 / ●	02800915 + 02800949 / ●	02800915 + 02800949 / ●	02800915 + 02800949 / ●	02800915 / ●	02800915 / ●	02800915 / ●	-
02800922* / O	02800922* / O	02800921 / O	02800921 / O	02800921 / O	02800921 / O	02800921 / O	02800921 / O	02800921 / O	02800921 / O	02800921 / O	-
02859398 / O	02859398 / O	02859394 / O	02859394 / O	02859394 / O	02859394 / O	02859394 / O	02859394 / O	02859488 / O	02859488 / O	02859488 / O	-
02893002 / O	02893002 / O	02893002 / O	02893002 / O	02893002 / O	02893002 / O	02893002 / O	02893002 / O	02893002 / O	02893002 / O	02893002 / O	-
02800014 / O	02800014 / O	-	-	-	-	-	-	-	-	-	-
02800013 / O	02800013 / O	-	-	-	-	-	-	-	-	-	-

Code	02059405	02078405	02027210	02059010	02078006	02027012	02059403	02032205
EAN	8422248102308	8422248102315	8422248102322	8422248102339	8422248102346	8422248102353	8422248108089	8422248102292
Model	WANDA 900 XGBK	WANDA 700 XGBK	WANDA 600 XGBK	WANDA 900 XGWH	WANDA 700 XGWH	WANDA 600 XGWH	LENA 900 XGBK	LENA 600 XGBK
Type	Vertical	Vertical	Vertical	Vertical	Vertical	Vertical	Vertical	Vertical
Product fiche according to directives EU65/2014 - EN61591, EN60704-2-13, EN50564								
AEC (Annual Energy consumption) (kWh/annum)	11,1	11,1	11,1	11,1	11,1	11,1	43,57	43,57
EEL class (Energy Efficiency Class)	A++	A++	A++	A++	A++	A++	B	B
FDE (Fluid Dynamic Efficiency)	29,5	29,5	29,5	29,5	29,5	29,5	22,94	22,94
FDE class (Fluid Dynamic Efficiency Class)	A	A	A	A	A	A	C	C
LE (Lighting Efficiency) (lux/W)	29,3	29,3	29,3	29,3	29,3	29,3	43,6	43,6
LE class (Lighting Efficiency Class)	A	A	A	A	A	A	A	A
GFE (Grease Filtering Efficiency)	76,1	76,1	76,1	76,1	76,1	76,1	82,6	82,6
GFE Class (Grease Filtering Efficiency class)	C	C	C	C	C	C	C	C
Air flow at minimum speed (m³/h)	207,2	207,2	207,2	207,2	207,2	207,2	310	311,71
Air flow at maximum speed (m³/h)	525,1	525,1	525,1	525,1	525,1	525,1	498,46	498,46
Air flow at intensive speed (TURBO) (m³/h)	-	-	-	-	-	-	-	-
Sound Power Level at minimum speed (dB)	39	39	39	39	39	39	44,1	44,1
Sound Power Level at maximum speed (dB)	59	59	59	59	59	59	62,8	62,8
Sound Power Level at intensive speed (TURBO) (dB)	-	-	-	-	-	-	-	-
Po (Power Consumption in off mode) (W)	0,44	0,44	0,44	0,44	0,44	0,44	-	-
Ps (Power Consumption in standby) (W)	-	-	-	-	-	-	0,34	0,34
Integration directive EU 66/2014								
f (Time Increase Factor)	0,9	0,883	0,883	0,883	0,883	0,883	1,17	1,17
EEL (Energy Efficiency Index)	34,9	38,6	38,6	38,6	38,6	38,6	62,2	62,2
Q _{best} (Flow Rate at Best Efficiency Point) (m³/h)	222,5	248,01	248,01	248,01	248,01	248,01	264,09	264,09
P _{best} (Static Pressure Difference at Best Efficiency Point) (Pa)	129	178,05	178,05	178,05	178,05	178,05	301,94	301,94
W _{best} (Electric Power Input at Best Efficiency Point) (W)	27	39,55	39,55	39,55	39,55	39,55	95,56	95,56
W _i (Nominal Power Consumption of Lighting system) (W)	3	3	3	3	3	3	3	3
E _{mean} (Average Illumination of Lighting system on Cooking surface) (lux)	88	163,8	163,8	163,8	163,8	163,8	130,8	130,8
External Dimensions								
Width (mm)	895	695	595	895	695	595	895	595
Depth (mm)	358	358	358	358	358	358	385	385
Total max height (mm)	1122	1122	1122	1122	1122	1122	1092	1092
Total min height (mm)	772	772	772	772	772	772	742	742
Outlet Diameter (mm)	150	150	150	150	150	150	150	150
Characteristics								
Motor	BLDC	BLDC	BLDC	BLDC	BLDC	BLDC	TT500	TT500
Extraction Levels	5+1	5+1	5+1	5+1	5+1	5+1	5+1	5+1
Maximum Power Consumption	70	70	70	70	70	70	120	120
Maximum Pressure	430	430	430	430	430	430	380	380
Intensive Speed (TURBO) Pressure	-	-	-	-	-	-	-	-
Control Type	T02	T02	T02	T02	T02	T02	T02	T02
Connectivity	-	-	-	-	-	-	-	-
Automatic removal	-	-	-	-	-	-	-	-
Automatic shut-down timer	√	√	√	√	√	√	√	√
Electronic Filter Saturation Indicator	-	-	-	-	-	-	-	-
Filter Type/ layers	Metallic	Metallic	Metallic	Metallic	Metallic	Metallic	Metallic	Metallic
Anti-grease Filter Number	1	1	1	1	1	1	1	1
Inner Shield	-	-	-	-	-	-	-	-
Glass damped open/closure	-	-	-	-	-	-	-	-
Air purification function	-	-	-	-	-	-	-	-
Air quality sensor	-	-	-	-	-	-	-	-
Anti-drip system	-	-	-	-	-	-	-	-
Lighting								
Light Type	LED	LED	LED	LED	LED	LED	LED	LED
Adjustable Intensity Lighting	-	-	-	-	-	-	-	-
Colour temperature	-	-	-	-	-	-	-	-
N° of Lamps	2	2	2	2	2	2	2	2
Installation								
Minimum height distance to a electric worktop hob (mm)	650	650	650	650	650	650	650	650
Minimum height distance to a gas worktop hob (mm)	650	650	650	650	650	650	650	650
Installation with Outlet tube to the exterior / Recirculating	BOTH	BOTH	BOTH	BOTH	BOTH	BOTH	BOTH	BOTH
Easy Installation System	√	√	√	√	√	√	√	√
Electric Connection								
Total Rush Power (W)	73	73	73	73	73	73	123	123
Rated Voltage (V)	220-240	220-240	220-240	220-240	220-240	220-240	220-240	220-240
Network Frequency (Hz)	50 / 60	50 / 60	50 / 60	50 / 60	50 / 60	50 / 60	50 / 60	50 / 60
Electrical Insulation Class	CLASS I	CLASS I	CLASS I	CLASS I	CLASS I	CLASS I	CLASS I	CLASS I
Plug	√	√	√	√	√	√	√	√
Accessories / ○ NOT INCLUDED ● INCLUDED								
Upper Decorative tube Extension	-	-	-	-	-	-	-	-
White Decorative Tube	-	-	-	-	-	-	-	-
Black Decorative Tube	-	-	-	-	-	-	-	-
Island Tube Enhancer	-	-	-	-	-	-	-	-
Check Valve	-	-	-	-	-	-	-	-
MAX PRO Metal Filter	-	-	-	-	-	-	-	-
Metal Filter	02800963 / ●	02800963 / ●	02800963 / ●	02800963 / ●	02800963 / ●	02800963 / ●	02800963 / ●	02800963 / ●
DUAL Filter (metal + active charcoal)	-	-	-	-	-	-	-	-
Active Charcoal Filter	02859492 / ○	02859492 / ○	02859492 / ○	02859492 / ○	02859492 / ○	02859492 / ○	02859492 / ○	02859492 / ○
Noiseless Flexible Duct	02893002 / ○	02893002 / ○	02893002 / ○	02893002 / ○	02893002 / ○	02893002 / ○	02893002 / ○	02893002 / ○
Top outlet motor cover	-	-	-	-	-	-	-	-
FCA kit without duct cover	-	-	-	-	-	-	-	-

02032206	02059011	02032005	02032006	02029207	02021202	02060208	02029306	02021308	02123305	02075305	02021310
8422248102377	8422248346559	8422248102285	8422248102360	8422248101493	8422248101509	8422248102544	8422248110037	8422248110044	8422248073035	8422248110051	8422248110068
LENA 500 XGBK	LENA 900 GWH	LENA 600 XGWH	LENA 500 XGWH	LEGEND 9000 XGBK	LEGEND 7000 XGBK	LEGEND 6000 XGBK	LEGEND 9010 X	LEGEND 7010 X	SYGMA 12010 X	SYGMA 9010 X	SYGMA 7010 X
Vertical	Vertical	Vertical	Vertical	Box	Box	Box	Box	Box	Box	Box	Box
43,57	43,57	43,57	43,57	9,9	10,8	9,9	23,1	23,1	53,6	53,6	53,6
B	B	B	B	A++	A++	A++	A++	A++	A	A	A
22,94	22,94	22,94	22,94	31,2	31,1	31,2	38,1	38,1	30,7	30,7	30,7
C	C	C	C	A	A	A	A	A	A	A	A
43,6	43,6	43,6	43,6	28,5	30	28,5	21	21	23,1	23,1	23,1
A	A	A	A	A	A	A	B	B	B	B	B
82,6	82,6	82,6	82,6	76,4	77,3	76,4	73,7	73,7	91,2	91,2	91,2
C	C	C	C	C	C	C	D	D	B	B	B
311,71	310	311,71	311,71	236,1	239,8	236,1	209,8	209,8	340	340	340
498,46	498,46	498,46	498,46	638,8	637,4	638,8	615,4	615,4	600	600	600
-	-	-	-	-	-	-	831,4	831,4	802	802	802
44,1	44,1	44,1	44,1	44	42	44	40	40	50	50	50
62,8	62,8	62,8	62,8	65	63	65	64	64	65	65	65
-	-	-	-	-	-	-	69	69	67	67	67
-	-	-	-	0,44	0,44	0,44	-	-	0,48	0,48	0,48
0,34	0,34	0,34	0,34	-	-	-	0,4	0,4	0,48	0,48	0,48
1,17	1,17	1,17	1,17	0,9	0,9	0,9	0,6	0,6	0,9	0,9	0,9
62,2	62,2	62,2	62,2	32,5	32	32,5	35,9	35,9	52,1	52,1	52,1
264,09	264,09	264,09	264,09	203,4	236,5	203,4	324,5	324,5	443,1	443,1	443,1
301,94	301,94	301,94	301,94	142	134	142	347	347	427,1	427,1	427,1
95,56	95,56	95,56	95,56	25,7	28,3	25,7	82	82	171	171	171
3	3	3	3	2	2	2	5,5	5,5	3	3	3
130,8	130,8	130,8	130,8	57	60	57	117	117	69	69	69
495	895	595	495	895	695	595	900	900	1200	900	700
385	385	385	385	500	500	500	495	495	496	495	495
1092	1092	1092	1092	998	998	998	990	990	1045	990	990
742	742	742	742	548	548	548	745	745	730	745	745
150	150	150	150	150	150	150	150	150	150	150	150
TT500	TT500	TT500	TT500	BLDC600	BLDC600	BLDC600	BT5DC	BT5DC	BT3	BT3	BT3
5+1	5+1	5+1	5+1	5+1	5+1	5+1	5+1	5+1	5+1	5+1	5+1
120	120	120	120	70	70	70	140	140	280	280	280
380	380	380	380	220	220	220	-	-	450	450	450
-	-	-	-	-	-	-	-	-	470	470	470
T02	T02	T02	T02	T02	T02	T02	SDX6i	SDX6i	SX4i	SX4i	SX4i
-	-	-	-	-	-	-	-	-	-	-	-
-	-	-	-	-	-	-	-	-	-	-	-
√	√	√	√	√	√	√	√	√	√	√	√
-	-	-	-	√	√	√	√	√	√	√	√
Metallic	Metallic	Metallic	Metallic	Metallic	Metallic	Metallic	Decorative stainless steel, antidrop	Decorative stainless steel, antidrop	Decorative stainless steel	Decorative stainless steel	Decorative stainless steel
1	1	1	1	3	2	2	3	2	4	3	2
-	-	-	-	-	-	-	-	-	-	-	-
-	-	-	-	-	-	-	-	-	-	-	-
-	-	-	-	-	-	-	-	-	-	-	-
-	-	-	-	-	-	-	-	-	-	-	-
LED	LED	LED	LED	CSLED	CSLED	CSLED	SS Led	SS Led	SS Led	SS Led	SS Led
-	-	-	-	-	-	-	√	√	√	√	√
-	-	-	-	-	-	-	-	-	White 4000°K	-	-
2	2	2	2	1	1	1	1	1	1	1	1
650	650	650	650	650	650	650	650	650	650	650	650
650	650	650	650	650	650	650	650	650	650	650	650
BOTH	BOTH	BOTH	BOTH	BOTH	BOTH	BOTH	BOTH	BOTH	BOTH	BOTH	BOTH
√	√	√	√	√	√	√	√	√	√	√	√
123	123	123	123	72	72	72	-	-	283	283	283
220-240	220-240	220-240	220-240	220-240	220-240	220-240	220-240	220-240	220-240	220-240	220-240
50 / 60	50 / 60	50 / 60	50 / 60	50-60	50-60	50-60	50	50	50	50	50
CLASS I	CLASS I	CLASS I	CLASS I	CLASS I	CLASS I	CLASS I	CLASS II	CLASS II	CLASS II	CLASS II	CLASS II
√	√	√	√	√	√	√	-	-	-	-	-
-	-	-	-	-	-	-	-	-	02861300 / O	02861300 / O	02861300 / O
-	-	-	-	-	-	-	-	-	-	-	-
-	-	-	-	-	-	-	-	-	02861401 / O	02861401 / O	02861401 / O
-	-	-	-	-	-	-	-	-	-	-	-
-	-	-	-	-	-	-	-	-	02832004 / O	02832004 / O	02832004 / O
02800963 / ●	02800963 / ●	02800963 / ●	02800963 / ●	02800974 / ●	02800973 / ●	02800975 / ●	-	-	02800004 / ●	02800213 / ●	02800213 / ●
-	-	-	-	-	-	-	-	-	02800922* / O	02800922* / O	02800922* / O
02859492 / O	02859492 / O	02859492 / O	02859492 / O	02859492 / O	02859492 / O	02859492 / O	02859492 / O	02859398 / O	02859398 / O	02859398 / O	02859398 / O
02893002 / O	02893002 / O	02893002 / O	02893002 / O	02893002 / O	02893002 / O	02893002 / O	02893002 / O	02893002 / O	02893002 / O	02893002 / O	02893002 / O

Code	02059405	02078405	02027210	02059010	02078006	02027012	02059403	02032205
EAN	8422248102308	8422248102315	8422248102322	8422248102339	8422248102346	8422248102353	8422248108089	8422248102292
Model	WANDA 900 XGBK	WANDA 700 XGBK	WANDA 600 XGBK	WANDA 900 XGWH	WANDA 700 XGWH	WANDA 600 XGWH	LENA 900 XGBK	LENA 600 XGBK
Type	Vertical	Vertical	Vertical	Vertical	Vertical	Vertical	Vertical	Vertical
Product fiche according to directives EU65/2014 - EN61591, EN60704-2-13, EN50564								
AEC (Annual Energy consumption) (kWh/annum)	11,1	11,1	11,1	11,1	11,1	11,1	43,57	43,57
EEL class (Energy Efficiency Class)	A++	A++	A++	A++	A++	A++	B	B
FDE (Fluid Dynamic Efficiency)	29,5	29,5	29,5	29,5	29,5	29,5	22,94	22,94
FDE class (Fluid Dynamic Efficiency Class)	A	A	A	A	A	A	C	C
LE (Lighting Efficiency) (lux/W)	29,3	29,3	29,3	29,3	29,3	29,3	43,6	43,6
LE class (Lighting Efficiency Class)	A	A	A	A	A	A	A	A
GFE (Grease Filtering Efficiency)	76,1	76,1	76,1	76,1	76,1	76,1	82,6	82,6
GFE Class (Grease Filtering Efficiency class)	C	C	C	C	C	C	C	C
Air flow at minimum speed (m³/h)	207,2	207,2	207,2	207,2	207,2	207,2	310	311,71
Air flow at maximum speed (m³/h)	525,1	525,1	525,1	525,1	525,1	525,1	498,46	498,46
Air flow at intensive speed (TURBO) (m³/h)	-	-	-	-	-	-	-	-
Sound Power Level at minimum speed (dB)	39	39	39	39	39	39	44,1	44,1
Sound Power Level at maximum speed (dB)	59	59	59	59	59	59	62,8	62,8
Sound Power Level at intensive speed (TURBO) (dB)	-	-	-	-	-	-	-	-
Po (Power Consumption in off mode) (W)	0,44	0,44	0,44	0,44	0,44	0,44	-	-
Ps (Power Consumption in standby) (W)	-	-	-	-	-	-	0,34	0,34
Integration directive EU 66/2014								
f (Time Increase Factor)	0,9	0,883	0,883	0,883	0,883	0,883	1,17	1,17
EEL (Energy Efficiency Index)	34,9	38,6	38,6	38,6	38,6	38,6	62,2	62,2
Q _{best} (Flow Rate at Best Efficiency Point) (m³/h)	222,5	248,01	248,01	248,01	248,01	248,01	264,09	264,09
P _{best} (Static Pressure Difference at Best Efficiency Point) (Pa)	129	178,05	178,05	178,05	178,05	178,05	301,94	301,94
W _{best} (Electric Power Input at Best Efficiency Point) (W)	27	39,55	39,55	39,55	39,55	39,55	95,56	95,56
W _i (Nominal Power Consumption of Lighting system) (W)	3	3	3	3	3	3	3	3
E _{mean} (Average Illumination of Lighting system on Cooking surface) (lux)	88	163,8	163,8	163,8	163,8	163,8	130,8	130,8
External Dimensions								
Width (mm)	895	695	595	895	695	595	895	595
Depth (mm)	358	358	358	358	358	358	385	385
Total max height (mm)	1122	1122	1122	1122	1122	1122	1092	1092
Total min height (mm)	772	772	772	772	772	772	742	742
Outlet Diameter (mm)	150	150	150	150	150	150	150	150
Characteristics								
Motor	BLDC	BLDC	BLDC	BLDC	BLDC	BLDC	TT500	TT500
Extraction Levels	5+1	5+1	5+1	5+1	5+1	5+1	5+1	5+1
Maximum Power Consumption	70	70	70	70	70	70	120	120
Maximum Pressure	430	430	430	430	430	430	380	380
Intensive Speed (TURBO) Pressure	-	-	-	-	-	-	-	-
Control Type	T02	T02	T02	T02	T02	T02	T02	T02
Connectivity	-	-	-	-	-	-	-	-
Automatic removal	-	-	-	-	-	-	-	-
Automatic shut-down timer	√	√	√	√	√	√	√	√
Electronic Filter Saturation Indicator	-	-	-	-	-	-	-	-
Filter Type/ layers	Metallic	Metallic	Metallic	Metallic	Metallic	Metallic	Metallic	Metallic
Anti-grease Filter Number	1	1	1	1	1	1	1	1
Inner Shield	-	-	-	-	-	-	-	-
Glass damped open/closure	-	-	-	-	-	-	-	-
Air purification function	-	-	-	-	-	-	-	-
Air quality sensor	-	-	-	-	-	-	-	-
Anti-drip system	-	-	-	-	-	-	-	-
Lighting								
Light Type	LED	LED	LED	LED	LED	LED	LED	LED
Adjustable Intensity Lighting	-	-	-	-	-	-	-	-
Colour temperature	-	-	-	-	-	-	-	-
N° of Lamps	2	2	2	2	2	2	2	2
Installation								
Minimum height distance to a electric worktop hob (mm)	650	650	650	650	650	650	650	650
Minimum height distance to a gas worktop hob (mm)	650	650	650	650	650	650	650	650
Installation with Outlet tube to the exterior / Recirculating	BOTH	BOTH	BOTH	BOTH	BOTH	BOTH	BOTH	BOTH
Easy Installation System	√	√	√	√	√	√	√	√
Electric Connection								
Total Rush Power (W)	73	73	73	73	73	73	123	123
Rated Voltage (V)	220-240	220-240	220-240	220-240	220-240	220-240	220-240	220-240
Network Frequency (Hz)	50 / 60	50 / 60	50 / 60	50 / 60	50 / 60	50 / 60	50 / 60	50 / 60
Electrical Insulation Class	CLASS I	CLASS I	CLASS I	CLASS I	CLASS I	CLASS I	CLASS I	CLASS I
Plug	√	√	√	√	√	√	√	√
Accessories / ○ NOT INCLUDED ● INCLUDED								
Upper Decorative tube Extension	-	-	-	-	-	-	-	-
White Decorative Tube	-	-	-	-	-	-	-	-
Black Decorative Tube	-	-	-	-	-	-	-	-
Island Tube Enhancer	-	-	-	-	-	-	-	-
Check Valve	-	-	-	-	-	-	-	-
MAX PRO Metal Filter	-	-	-	-	-	-	-	-
Metal Filter	02800963 / ●	02800963 / ●	02800963 / ●	02800963 / ●	02800963 / ●	02800963 / ●	02800963 / ●	02800963 / ●
DUAL Filter (metal + active charcoal)	-	-	-	-	-	-	-	-
Active Charcoal Filter	02859492 / ○	02859492 / ○	02859492 / ○	02859492 / ○	02859492 / ○	02859492 / ○	02859492 / ○	02859492 / ○
Noiseless Flexible Duct	02893002 / ○	02893002 / ○	02893002 / ○	02893002 / ○	02893002 / ○	02893002 / ○	02893002 / ○	02893002 / ○
Top outlet motor cover	-	-	-	-	-	-	-	-
FCA kit without duct cover	-	-	-	-	-	-	-	-

02032206	02059011	02032005	02032006	02029207	02021202	02060208	02029306	02021308	02123305	02075305	02021310
8422248102377	8422248346559	8422248102285	8422248102360	8422248101493	8422248101509	8422248102544	8422248110037	8422248110044	8422248073035	8422248110051	8422248110068
LENA 500 XGBK	LENA 900 GWH	LENA 600 XGWH	LENA 500 XGWH	LEGEND 900 XGBK	LEGEND 7000 XGBK	LEGEND 6000 XGBK	LEGEND 9010 X	LEGEND 7010 X	SYGMA 12010 X	SYGMA 9010 X	SYGMA 7010 X
Vertical	Vertical	Vertical	Vertical	Box	Box	Box	Box	Box	Box	Box	Box
43,57	43,57	43,57	43,57	9,9	10,8	9,9	23,1	23,1	53,6	53,6	53,6
B	B	B	B	A++	A++	A++	A++	A++	A	A	A
22,94	22,94	22,94	22,94	31,2	31,1	31,2	38,1	38,1	30,7	30,7	30,7
C	C	C	C	A	A	A	A	A	A	A	A
43,6	43,6	43,6	43,6	28,5	30	28,5	21	21	23,1	23,1	23,1
A	A	A	A	A	A	A	B	B	B	B	B
82,6	82,6	82,6	82,6	76,4	77,3	76,4	73,7	73,7	91,2	91,2	91,2
C	C	C	C	C	C	C	D	D	B	B	B
311,71	310	311,71	311,71	236,1	239,8	236,1	209,8	209,8	340	340	340
498,46	498,46	498,46	498,46	638,8	637,4	638,8	615,4	615,4	600	600	600
-	-	-	-	-	-	-	831,4	831,4	802	802	802
44,1	44,1	44,1	44,1	44	42	44	40	40	50	50	50
62,8	62,8	62,8	62,8	65	63	65	64	64	65	65	65
-	-	-	-	-	-	-	69	69	67	67	67
-	-	-	-	0,44	0,44	0,44	-	-	0,48	0,48	0,48
0,34	0,34	0,34	0,34	-	-	-	0,4	0,4	0,48	0,48	0,48
1,17	1,17	1,17	1,17	0,9	0,9	0,9	0,6	0,6	0,9	0,9	0,9
62,2	62,2	62,2	62,2	32,5	32	32,5	35,9	35,9	52,1	52,1	52,1
264,09	264,09	264,09	264,09	203,4	236,5	203,4	324,5	324,5	443,1	443,1	443,1
301,94	301,94	301,94	301,94	142	134	142	347	347	427,1	427,1	427,1
95,56	95,56	95,56	95,56	25,7	28,3	25,7	82	82	171	171	171
3	3	3	3	2	2	2	5,5	5,5	3	3	3
130,8	130,8	130,8	130,8	57	60	57	117	117	69	69	69
495	895	595	495	895	695	595	900	900	1200	900	700
385	385	385	385	500	500	500	495	495	496	495	495
1092	1092	1092	1092	998	998	998	990	990	1045	990	990
742	742	742	742	548	548	548	745	745	730	745	745
150	150	150	150	150	150	150	150	150	150	150	150
TT500	TT500	TT500	TT500	BLDC600	BLDC600	BLDC600	BT5DC	BT5DC	BT3	BT3	BT3
5+1	5+1	5+1	5+1	5+1	5+1	5+1	5+1	5+1	5+1	5+1	5+1
120	120	120	120	70	70	70	140	140	280	280	280
380	380	380	380	220	220	220	-	-	450	450	450
-	-	-	-	-	-	-	-	-	470	470	470
T02	T02	T02	T02	T02	T02	T02	SDX6i	SDX6i	SX4i	SX4i	SX4i
-	-	-	-	-	-	-	-	-	-	-	-
-	-	-	-	-	-	-	-	-	-	-	-
√	√	√	√	√	√	√	√	√	√	√	√
-	-	-	-	√	√	√	√	√	√	√	√
Metallic	Metallic	Metallic	Metallic	Metallic	Metallic	Metallic	Decorative stainless steel, antidrop	Decorative stainless steel, antidrop	Decorative stainless steel	Decorative stainless steel	Decorative stainless steel
1	1	1	1	3	2	2	3	2	4	3	2
-	-	-	-	-	-	-	-	-	-	-	-
-	-	-	-	-	-	-	-	-	-	-	-
-	-	-	-	-	-	-	-	-	-	-	-
-	-	-	-	-	-	-	-	-	-	-	-
LED	LED	LED	LED	CSLED	CSLED	CSLED	SS Led	SS Led	SS Led	SS Led	SS Led
-	-	-	-	-	-	-	√	√	√	√	√
-	-	-	-	-	-	-	-	-	White 4000°K	-	-
2	2	2	2	1	1	1	1	1	1	1	1
650	650	650	650	650	650	650	650	650	650	650	650
650	650	650	650	650	650	650	650	650	650	650	650
BOTH	BOTH	BOTH	BOTH	BOTH	BOTH	BOTH	BOTH	BOTH	BOTH	BOTH	BOTH
√	√	√	√	√	√	√	√	√	√	√	√
123	123	123	123	72	72	72	-	-	283	283	283
220-240	220-240	220-240	220-240	220-240	220-240	220-240	220-240	220-240	220-240	220-240	220-240
50 / 60	50 / 60	50 / 60	50 / 60	50-60	50-60	50-60	50	50	50	50	50
CLASS I	CLASS I	CLASS I	CLASS I	CLASS I	CLASS I	CLASS I	CLASS II	CLASS II	CLASS II	CLASS II	CLASS II
√	√	√	√	√	√	√	-	-	-	-	-
-	-	-	-	-	-	-	-	-	02861300 / O	02861300 / O	02861300 / O
-	-	-	-	-	-	-	-	-	-	-	-
-	-	-	-	-	-	-	-	-	02861401 / O	02861401 / O	02861401 / O
-	-	-	-	-	-	-	-	-	-	-	-
-	-	-	-	-	-	-	-	-	02832004 / O	02832004 / O	02832004 / O
02800963 / ●	02800963 / ●	02800963 / ●	02800963 / ●	02800974 / ●	02800973 / ●	02800975 / ●	-	-	02800004 / ●	02800213 / ●	02800213 / ●
-	-	-	-	-	-	-	-	-	02800922* / O	02800922* / O	02800922* / O
02859492 / O	02859492 / O	02859492 / O	02859492 / O	02859492 / O	02859492 / O	02859492 / O	02859492 / O	02859492 / O	02859398 / O	02859398 / O	02859398 / O
02893002 / O	02893002 / O	02893002 / O	02893002 / O	02893002 / O	02893002 / O	02893002 / O	02893002 / O	02893002 / O	02893002 / O	02893002 / O	02893002 / O

Code	02060310	02075401	02021400	02060400	02075410	02075411	02075412	02075413
EAN	8422248110075	8422248110082	8422248357272	8422248357289	8422248371421	8422248371438	8422248371445	8422248371452
Model	SYGMA 6010 X	SYGMA 9010 BK	SYGMA 7010 BK	SYGMA 6010 BK	S PRO 9000 X	S PRO 7000 X	S PRO 6000 X	S PRO 9000 BK
Type	Box	Box	Box	Box	Box	Box	Box	Box
Product fiche according to directives EU65/2014 - EN61591, EN60704-2-13, EN50564								
AEC (Annual Energy consumption) (kWh/annum)	53,6	53,6	53,6	53,6	59,8	67,7	67,8	59,8
EEL class (Energy Efficiency Class)	A	A	A	A	A	A	A	A
FDE (Fluid Dynamic Efficiency)	30,7	30,7	30,7	30,7	29,3	29,2	29,2	29,3
FDE class (Fluid Dynamic Efficiency Class)	A	A	A	A	A	A	A	A
LE (Lighting Efficiency) (lux/W)	23,1	23,1	23,1	23,1	35	43	47	35
LE class (Lighting Efficiency Class)	B	B	B	B	A	A	A	A
GFE (Grease Filtering Efficiency)	91,2	91,2	91,2	91,2	76,3	76,3	76,3	76,3
GFE Class (Grease Filtering Efficiency class)	B	B	B	B	C	C	C	C
Air flow at minimum speed (m³/h)	340	340	340	340	419	419	417	419
Air flow at maximum speed (m³/h)	600	600	600	600	628,2	573,9	577,7	628,2
Air flow at intensive speed (TURBO) (m³/h)	802	802	802	802	1027	1001	1001	1027
Sound Power Level at minimum speed (dB)	50	50	50	50	64	64	64	64
Sound Power Level at maximum speed (dB)	65	65	65	65	73	72	72	73
Sound Power Level at intensive speed (TURBO) (dB)	67	67	67	67	76	75	75	76
Po (Power Consumption in off mode) (W)	0,48	0,48	0,48	0,48	-	-	-	-
Ps (Power Consumption in standby) (W)	0,48	0,48	0,48	0,48	0,48	0,48	0,48	0,48
Integration directive EU 66/2014								
f (Time Increase Factor)	0,9	0,9	0,9	0,9	0,9	0,9	0,9	0,9
EEL (Energy Efficiency Index)	52,1	52,1	52,1	52,1	53,1	53,8	53,8	53,1
Q _{SEP} (Flow Rate at Best Efficiency Point) (m³/h)	443,1	443,1	443,1	443,1	438,2	489	497,7	438,2
P _{SEP} (Static Pressure Difference at Best Efficiency Point) (Pa)	427,1	427,1	427,1	427,1	416	424	417	416
W _{SEP} (Electric Power Input at Best Efficiency Point) (W)	171	171	171	171	172,8	196,9	197,4	172,8
W _i (Nominal Power Consumption of Lighting system) (W)	3	3	3	3	4,2	4,1	4,1	4,2
E _{mean} (Average Illumination of Lighting system on Cooking surface) (lux)	69	69	69	69	147,6	176,4	190,8	147,6
External Dimensions								
Width (mm)	600	900	700	600	900	700	600	900
Depth (mm)	495	495	495	495	500	500	500	500
Total max height (mm)	990	990	990	990	820	830	820	820
Total min height (mm)	745	745	745	745	440	450	440	440
Outlet Diameter (mm)	150	150	150	150	150	150	150	150
Characteristics								
Motor	BT3	BT3	BT3	BT3	A1000	A1000	A1000	A1000
Extraction Levels	5+1	5+1	5+1	5+1	2+1	2+1	2+1	2+1
Maximum Power Consumption	280	280	280	280	380	380	380	380
Maximum Pressure	450	450	450	450	474,33	501,17	473,39	474,33
Intensive Speed (TURBO) Pressure	470	470	470	470	486,76	516,3	503,39	486,76
Control Type	SX4i	SX4i	SX4i	SX4i	AED1	AED1	AED1	AED1
Connectivity	-	-	-	-	-	-	-	-
Automatic removal	-	-	-	-	-	-	-	-
Automatic shut-down timer	√	√	√	√	√	√	√	√
Electronic Filter Saturation Indicator	√	√	√	√	-	-	-	-
Filter Type/ layers	Decorative stainless steel	Decorative stainless steel	Decorative stainless steel	Decorative stainless steel	Metallic	Metallic	Metallic	Metallic
Anti-grease Filter Number	2	3	2	2	3	2	2	3
Inner Shield	-	-	-	-	-	-	-	-
Glass damped open/closure	-	-	-	-	-	-	-	-
Air purification function	-	-	-	-	-	-	-	-
Air quality sensor	-	-	-	-	-	-	-	-
Anti-drip system	-	-	-	-	-	-	-	-
Lighting								
Light Type	SS Led	SS Led	SS Led	SS Led	EcoLed	EcoLed	EcoLed	EcoLed
Adjustable Intensity Lighting	√	√	√	√	-	-	-	-
Colour temperature	-	-	-	-	White 6500°K	White 6500°K	White 6500°K	White 6500°K
N° of Lamps	1	1	1	1	2	2	2	2
Installation								
Minimum height distance to a electric worktop hob (mm)	650	650	650	650	650	650	650	650
Minimum height distance to a gas worktop hob (mm)	650	650	650	650	650	650	650	650
Installation with Outlet tube to the exterior / Recirculating	BOTH	BOTH	BOTH	BOTH	BOTH	BOTH	BOTH	BOTH
Easy Installation System	√	√	√	√	√	√	√	√
Electric Connection								
Total Rush Power (W)	283	283	283	283	383	383	383	383
Rated Voltage (V)	220-240	220-240	220-240	220-240	220-240	220-240	220-240	220-240
Network Frequency (Hz)	50	50	50	50	50	50	50	50
Electrical Insulation Class	CLASS II	CLASS II	CLASS II	CLASS II	CLASS I	CLASS I	CLASS I	CLASS I
Plug	-	-	-	-	√	√	√	√
Accessories / ○ NOT INCLUDED ● INCLUDED								
Upper Decorative tube Extension	02861300 / ○	02861300 / ○	02861300 / ○	02861300 / ○	-	-	-	-
White Decorative Tube	-	-	-	-	-	-	-	-
Black Decorative Tube	02861401 / ○	02861401 / ○	02861401 / ○	02861401 / ○	-	-	-	-
Island Tube Enhancer	-	-	-	-	-	-	-	-
Check Valve	02832004 / ○	02832004 / ○	02832004 / ○	02832004 / ○	02800706 / ●	02800706 / ●	02800706 / ●	02800706 / ●
MAX PRO Metal Filter	-	-	-	-	-	-	-	-
Metal Filter	02800213 / ●	02800213 / ●	02800213 / ●	02800213 / ●	02800708 / ●	02800708 / ●	02800708 / ●	02800708 / ●
DUAL Filter (metal + active charcoal)	02800922* / ○	02800922* / ○	02800922* / ○	02800922* / ○	-	-	-	-
Active Charcoal Filter	02859398 / ○	02859398 / ○	02859398 / ○	02859398 / ○	-	-	-	-
Noiseless Flexible Duct	02893002 / ○	02893002 / ○	02893002 / ○	02893002 / ○	-	-	-	-
Top outlet motor cover	-	-	-	-	-	-	-	-
FCA kit without duct cover	-	-	-	-	-	-	-	-

02075414	02075415	02029602	02021602	02060602	02029309	02021309	02060309	02060609	02008107	02005107	02005407
8422248371476	8422248371506	8422248093422	8422248093446	8422248093453	8422248108706	8422248108690	8422248108683	8422248356978	8422248356992	8422248356985	8422248357005
S PRO 7000 BK	S PRO 6000 BK	S PLUS 9010 X	S PLUS 7010 X	S PLUS 6010 X	ST-9000 X	ST-7000 X	ST-6000 X	SK 6000 X	CK 9000 X	CK 6000 X	CK 6000 BK
Box	Box	Box	Box	Box	Box	Box	Box	Box	Curved Glass	Curved Glass	Curved Glass
67,7	67,8	100,9	98,7	98,7	36,4	36	36,1	24,7	24,7	24,7	24,7
A	A	C	C	C	C	C	C	A	A	A	A
29,2	29,2	16,3	16,3	16,3	10,12	9,84	9,48	25,6	25,6	25,6	25,6
A	A	D	D	D	E	E	E	B	B	B	B
43	47	22,5	30,3	30,3	39,3	38,9	39,6	31,6	31,6	31,6	31,6
A	A	B	A	A	A	A	A	A	A	A	A
76,3	76,3	88,5	88,5	88,5	70,46	70,11	72,14	74,6	74,6	74,6	74,6
C	C	B	B	B	D	D	D	D	D	D	D
419	417	361	361	361	165	161	166	166	175	175	175
573,9	577,7	637	637	637	302	294	292	380	440	440	440
1001	1001	-	-	-	-	-	-	-	-	-	-
64	64	69	69	69	58	58	58	52	52	52	52
72	72	74	74	74	62	63,5	62,4	68	69	69	69
75	75	-	-	-	-	-	-	-	-	-	-
-	-	0	0	0	0	0	0	0	0	0	0
0,48	0,48	-	-	-	-	-	-	-	-	-	-
0,9	0,9	1,4	1,4	1,4	1,6	1,7	1,7	1,1	1,1	1,1	1,1
53,8	53,8	82,4	81,7	81,7	74,9	75	75,4	51,7	51,7	51,7	51,7
489	497,7	375,3	375,3	375,3	192,63	172,17	171	216,1	216,1	216,1	216,1
424	417	295	295	295	110,53	118,37	114,29	238,5	238,5	238,5	238,5
196,9	197,4	188,8	188,8	188,8	58,45	57,55	57,27	56	56	56	56
4,1	4,1	6	3	3	2	2	2	3	3	3	3
176,4	190,8	135	91	91	79	78	79	95	95	95	95
700	600	900	700	600	900	700	600	600	900	600	600
500	500	500	500	500	500	500	500	470	470	470	470
830	820	1045	1045	1045	998	998	998	1130	915	915	915
450	440	745	745	745	548	548	548	594	670	670	670
150	150	150	150	150	150	150	150	150	150	150	150
A1000	A1000	M3R	M3R	M3R	TT300	TT300	TT300	K10	K10	K10	K10
2+1	2+1	5+1	5+1	5+1	5+1	5+1	5+1	3	3	3	3
380	380	270	270	270	65	65	65	100	110	110	110
501,17	473,39	430	430	430	172,85	171,83	174,66	293	293	293	293
516,3	503,39	-	-	-	-	-	-	-	-	-	-
AED1	AED1	Mechanic	Mechanic	Mechanic	Mechanic	Mechanic	Mechanic	Mechanic	Mechanic	Mechanic	Mechanic
-	-	-	-	-	-	-	-	-	-	-	-
-	-	-	-	-	-	-	-	-	-	-	-
v	v	-	-	-	-	-	-	-	-	-	-
-	-	-	-	-	-	-	-	-	-	-	-
Metallic	Metallic	Metallic	Metallic	Metallic	Metallic	Metallic	Metallic	Metallic	Metallic	Metallic	Metallic
2	2	3	2	2	3	2	2	2	3	2	2
-	-	-	-	-	-	-	-	-	-	-	-
-	-	-	-	-	-	-	-	-	-	-	-
-	-	-	-	-	-	-	-	-	-	-	-
-	-	-	-	-	-	-	-	-	-	-	-
EcoLed	EcoLed	CSLED	CSLED	CSLED	CSLED	CSLED	CSLED	CSLED	CSLED	CSLED	CSLED
-	-	-	-	-	-	-	-	-	-	-	-
White 6500°K	White 6500°K	-	-	-	-	-	-	-	-	-	-
2	2	2	1	1	1	1	1	1	1	1	1
650	650	650	650	650	650	650	650	650	650	650	650
BOTH	BOTH	BOTH	BOTH	BOTH	BOTH	BOTH	BOTH	BOTH	BOTH	BOTH	BOTH
v	v	v	v	v	v	v	v	v	v	v	v
383	383	277	277	277	67	67	67	103	113	113	113
220-240	220-240	220-240	220-240	220-240	220-240	220-240	220-240	220-240	220-240	220-240	220-240
50	50	50	50	50	50	50	50	50	50	50	50
CLASS I	CLASS I	CLASS II	CLASS II	CLASS II	CLASS I	CLASS I	CLASS I	CLASS II	CLASS II	CLASS II	CLASS II
v	v	-	-	-	-	-	-	-	-	-	-
-	-	02861300 / O	02861300 / O	02861300 / O	02861300 / O	02861300 / O	02861300 / O	02861302 / O	-	-	-
-	-	-	-	-	-	-	-	-	-	-	-
-	-	02861401 / O	02861401 / O	02861401 / O	02861401 / O	02861401 / O	02861401 / O	-	-	-	-
-	-	-	-	-	-	-	-	-	-	-	-
02800706 / ●	02800706 / ●	02832001 / O	02832001 / O	02832001 / O	-	-	-	02832004 / O	02832004 / O	02832004 / O	02832004 / O
-	-	-	-	-	-	-	-	02800917 / O	-	-	-
02800708 / ●	02800708 / ●	02800930 / ●	02800930 / ●	02800930 / ●	02800984 / ●	02800983 / ●	02800963 / ●	02800905* / ●	02819000* / ●	02800905* / ●	02800905* / ●
-	-	02800922* / O	02800922* / O	02800922* / O	02859495 / O	02859495 / O	02859495 / O	02800918 / O	-	-	-
-	-	02859398 / O	02859398 / O	02859398 / O	02859398 / O	02859398 / O	02859398 / O	02859489 / O	02859489 / O	02859489 / O	02859489 / O
-	-	02893002 / O	02893002 / O	02893002 / O	02893002 / O	02893002 / O	02893002 / O	02893002 / O	02893002 / O	02893002 / O	02893002 / O
-	-	-	-	-	-	-	-	-	-	-	-
-	-	-	-	-	-	-	-	-	-	-	-

Code	02008299	02005299	02075416	02075417	02075418	02075419	02075420	02075421
EAN	8422248108102	8422248097413	02075416	02075417	02075418	02075419	02075420	02075421
Model	CG5-T900 X	CG5-T600 X	BETA PRO 9000 X	BETA PRO 7000 X	BETA PRO 6000 X	BETA PRO 9000 BK	BETA PRO 7000 BK	BETA PRO 6000 BK
Type	Curved Glass	Curved Glass	Chimney	Chimney	Chimney	Chimney	Chimney	Chimney
Product fiche according to directives EU65/2014 - EN61591, EN60704-2-13, EN50564								
AEC (Annual Energy consumption) (kWh/annum)	47,6	46,4	68,1	64,1	63,5	68,1	64,1	63,5
EEL class (Energy Efficiency Class)	B	B	A	A	A	A	A	A
FDE (Fluid Dynamic Efficiency)	22,2	20,4	29,3	29,2	29,2	29,3	29,2	29,2
FDE class (Fluid Dynamic Efficiency Class)	C	C	A	A	A	A	A	A
LE (Lighting Efficiency) (lux/W)	49,33	49,33	28	34	33	28	34	33
LE class (Lighting Efficiency Class)	A	A	A	A	A	A	A	A
GFE (Grease Filtering Efficiency)	82,87	73,86	75,9	75,5	75,2	75,9	75,5	75,2
GFE Class (Grease Filtering Efficiency class)	C	D	C	C	C	C	C	C
Air flow at minimum speed (m³/h)	296	304,5	411	407	441	411	407	441
Air flow at maximum speed (m³/h)	495	499	561	564	621	561	564	621
Air flow at intensive speed (TURBO) (m³/h)	-	-	979	971	990	979	971	990
Sound Power Level at minimum speed (dB)	45,5	43,5	64	65	65	64	65	65
Sound Power Level at maximum speed (dB)	66	67,6	72	72	71	72	72	71
Sound Power Level at intensive speed (TURBO) (dB)	-	-	75	75	75	75	75	75
Po (Power Consumption in off mode) (W)	0	0	0	0	0	0	0	0
Ps (Power Consumption in standby) (W)	-	-	0,48	0,48	0,48	0,48	0,48	0,48
Integration directive EU 66/2014								
f (Time Increase Factor)	1,2	1,27	0,9	0,9	0,9	0,9	0,9	0,9
EEL (Energy Efficiency Index)	64,4	66,7	53,7	53,5	53,5	53,7	53,5	53,5
Q _{SEP} (Flow Rate at Best Efficiency Point) (m³/h)	287,5	260	482,8	441,8	457,9	482,8	441,8	457,9
P _{SEP} (Static Pressure Difference at Best Efficiency Point) (Pa)	288	270	434	443	422	434	443	422
W _{SEP} (Electric Power Input at Best Efficiency Point) (W)	103,6	95,7	198,6	186,1	183,9	198,6	186,1	183,9
W _N (Nominal Power Consumption of Lighting system) (W)	3	3	4	4,1	4,2	4	4,1	4,2
E _{MINI} (Average Illumination of Lighting system on Cooking surface) (lux)	148	148	112,5	139,5	140,4	112,5	139,5	140,4
External Dimensions								
Width (mm)	900	600	900	700	600	900	700	600
Depth (mm)	470	470	500	500	500	500	500	500
Total max height (mm)	776	776	1080	1080	1080	1080	1080	1080
Total min height (mm)	426	426	700	700	700	700	700	700
Outlet Diameter (mm)	150	150	150	150	150	150	150	150
Characteristics								
Motor	TT500	TT500	A1000	A1000	A1000	A1000	A1000	A1000
Extraction Levels	5+1	5+1	2+1	2+1	2+1	2+1	2+1	2+1
Maximum Power Consumption	120	120	380	380	380	380	380	380
Maximum Pressure	435	430	474,33	501,17	473,39	474,33	501,17	473,39
Intensive Speed (TURBO) Pressure	-	-	486,76	516,3	503,39	486,76	516,3	503,39
Control Type	Mechanic	Mechanic	AED1	AED1	AED1	AED1	AED1	AED1
Connectivity	-	-	-	-	-	-	-	-
Automatic removal	-	-	-	-	-	-	-	-
Automatic shut-down timer	-	-	√	√	√	√	√	√
Electronic Filter Saturation Indicator	-	-	-	-	-	-	-	-
Filter Type/ layers	Metallic	Metallic	Metallic	Metallic	Metallic	Metallic	Metallic	Metallic
Anti-grease Filter Number	1	1	3	2	2	3	2	2
Inner Shield	-	-	-	-	-	-	-	-
Glass damped open/closure	-	-	-	-	-	-	-	-
Air purification function	-	-	-	-	-	-	-	-
Air quality sensor	-	-	-	-	-	-	-	-
Anti-drip system	-	-	-	-	-	-	-	-
Lighting								
Light Type	LED	LED	EcoLed	EcoLed	EcoLed	EcoLed	EcoLed	EcoLed
Adjustable Intensity Lighting	-	-	-	-	-	-	-	-
Colour temperature	-	-	White 6500°K	White 6500°K	White 6500°K	White 6500°K	White 6500°K	White 6500°K
N° of Lamps	2	2	2	2	2	2	2	2
Installation								
Minimum height distance to a electric worktop hob (mm)	650	650	650	650	650	650	650	650
Minimum height distance to a gas worktop hob (mm)	650	650	750	750	750	750	750	750
Installation with Outlet tube to the exterior / Recirculating	BOTH	BOTH	BOTH	BOTH	BOTH	BOTH	BOTH	BOTH
Easy Installation System	√	√	√	√	√	√	√	√
Electric Connection								
Total Rush Power (W)	123	123	383	383	383	383	383	383
Rated Voltage (V)	220-240	220-240	220-240	220-240	220-240	220-240	220-240	220-240
Network Frequency (Hz)	50/60	50/60	50	50	50	50	50	50
Electrical Insulation Class	CLASS I	CLASS I	CLASS I	CLASS I	CLASS I	CLASS I	CLASS I	CLASS I
Plug	VDE	VDE	√	√	√	√	√	√
Accessories / ○ NOT INCLUDED ● INCLUDED								
Upper Decorative tube Extension	-	-	-	-	-	-	-	-
White Decorative Tube	-	-	-	-	-	-	-	-
Black Decorative Tube	-	-	-	-	-	-	-	-
Island Tube Enhancer	-	-	-	-	-	-	-	-
Check Valve	-	-	02800706 / ●	02800706 / ●	02800706 / ●	02800706 / ●	02800706 / ●	02800706 / ●
MAX PRO Metal Filter	-	-	-	-	-	-	-	-
Metal Filter	02800963 / ●	02800963 / ●	02800708 / ●	02800708 / ●	02800708 / ●	02800708 / ●	02800708 / ●	02800708 / ●
DUAL Filter (metal + active charcoal)	-	-	-	-	-	-	-	-
Active Charcoal Filter	02859501 / ○	02859501 / ○	-	-	-	-	-	-
Noiseless Flexible Duct	02893002 / ○	02893002 / ○	-	-	-	-	-	-
Top outlet motor cover	-	-	-	-	-	-	-	-
FCA kit without duct cover	-	-	-	-	-	-	-	-

02004310	02003307	02003310	02002310	02004410	02002410	02004010	02003010	02002010	02063603	02085602	02061606
8422248190596	8422248101615	8422248190602	8422248109826	8422248190633	8422248109833	8422248190619	8422248190626	8422248109819	8422248371186	8422248371193	8422248357012
OMEGA 900 X / M	OMEGA 7500 X	OMEGA 700 X / M	OMEGA 600 X / M	OMEGA 900 BK / M	OMEGA 600 BK / M	OMEGA 900 WH / M	OMEGA 700 WH / M	OMEGA 600 WH / M	VK 9000 X	VK 7000 X	VK 6000 X
Chimney	Chimney	Chimney	Chimney	Chimney	Chimney	Chimney	Chimney	Chimney	Chimney	Chimney	Chimney
105,4	40,9	95,4	95,4	105,4	95,4	105,4	95,4	95,4	24,8	24,8	24,8
C	A	C	C	C	C	C	C	C	A	A	A
20	30,4	17,8	17,8	20	17,8	20	17,8	17,8	28,5	28,5	28,5
C	A	D	D	C	D	C	D	D	B	B	B
21	37	26	26	21	26	21	26	26	31,6	31,6	31,6
B	A	B	B	B	B	B	B	B	A	A	A
90,3	78,8	90,3	90,3	90,3	90,3	90,3	90,3	90,3	71,4	71,4	71,4
B	C	B	B	B	B	B	B	B	D	D	D
385	412,5	385	385	385	385	385	385	385	175	175	175
645	592,9	645	645	645	645	645	645	645	480	480	480
-	-	-	-	-	-	-	-	-	-	-	-
57,8	58	57,8	57,8	57,8	57,8	57,8	57,8	57,8	56	56	56
71,8	68	71,8	71,8	71,8	71,8	71,8	71,8	71,8	67	67	67
-	-	-	-	-	-	-	-	-	-	-	-
0	0	0	0	0	0	0	0	0	0	0	0
0	-	0	0	0	0	0	0	0	-	-	-
1,3	0,9	1,4	1,4	1,3	1,4	1,3	1,4	1,4	1	1	1
77,6	49,9	81,3	81,3	77,6	81,3	77,6	81,3	81,3	48,5	48,5	48,5
458,1	344,7	371,8	371,8	458,1	371,8	458,1	371,8	371,8	255,1	255,1	255,1
333,8	379	314	314	333,8	314	333,8	314	314	249,1	249,1	249,1
213	119,4	182,5	182,5	213	182,5	213	182,5	182,5	62	62	62
6	2	3	3	6	3	6	3	3	3	3	3
126	73	78	78	126	78	126	78	78	95	95	95
900	745	700	600	900	600	900	700	600	900	700	600
500	480	500	500	500	500	500	500	500	475	475	475
1020	990	1020	1020	1020	1020	1020	1020	1020	910	910	910
720	640	720	720	720	720	720	720	720	670	670	670
150	150	150	150	150	150	150	150	150	150/120	150/120	150/120
M3R	TT600	M3R	M3R	M3R	M3R	M3R	M3R	M3R	K10	K10	K10
5+1	5+1	5+1	5+1	5+1	5+1	5+1	5+1	5+1	3	3	3
270	200	270	270	270	270	270	270	270	110	110	110
430	470	430	430	430	430	430	430	430	290,8	290,8	290,8
-	-	-	-	-	-	-	-	-	-	-	-
Mechanic	Mechanic	Mechanic	Mechanic	Mechanic	Mechanic	Mechanic	Mechanic	Mechanic	Mechanic	Mechanic	Mechanic
-	-	-	-	-	-	-	-	-	-	-	-
-	-	-	-	-	-	-	-	-	-	-	-
-	-	-	-	-	-	-	-	-	-	-	-
-	-	-	-	-	-	-	-	-	-	-	-
Metallic	Metallic	Metallic	Metallic	Metallic	Metallic	Metallic	Metallic	Metallic	Metallic	Metallic	Metallic
3	2	2	1	3	1	3	2	1	3	2	2
-	-	-	-	-	-	-	-	-	-	-	-
-	-	-	-	-	-	-	-	-	-	-	-
-	-	-	-	-	-	-	-	-	-	-	-
-	-	-	-	-	-	-	-	-	-	-	-
-	-	-	-	-	-	-	-	-	-	-	-
CSLED	CSLED	CSLED	CSLED	CSLED	CSLED	CSLED	CSLED	CSLED	CSLED	CSLED	CSLED
-	-	-	-	-	-	-	-	-	-	-	-
2	1	1	1	2	1	2	1	1	1	1	1
650	650	650	650	650	650	650	650	650	650	650	650
650	650	650	650	650	650	650	650	650	650	650	650
BOTH	BOTH	BOTH	BOTH	BOTH	BOTH	BOTH	BOTH	BOTH	BOTH	BOTH	BOTH
√	√	√	√	√	√	√	√	√	√	√	√
276	202	273	273	276	273	276	273	273	113	113	113
220-240	220-240	220-240	220-240	220-240	220-240	220-240	220-240	220-240	220-240	220-240	220-240
50	50/60	50	50	50	50	50	50	50	50	50	50
CLASS II	CLASS I	CLASS II	CLASS II	CLASS II	CLASS II	CLASS II	CLASS II	CLASS II	CLASS II	CLASS II	CLASS II
No	VDE	No	No	No	No	No	No	No	-	-	-
02862301 / O	-	02862301 / O	02862301 / O	-	-	-	-	-	02862302 / O	02862302 / O	02862302 / O
-	-	-	-	-	-	-	-	-	-	-	-
-	-	-	-	-	-	-	-	-	-	-	-
-	-	-	-	-	-	-	-	-	-	-	-
02832001 / O	-	02832001 / O	02832001 / O	02832001 / O	02832001 / O	02832001 / O	02832001 / O	02832001 / O	02832004 / O	02832004 / O	02832004 / O
02800917 / O	-	02800917 / O	02800917 / O	02800917 / O	02800917 / O	02800917 / O	02800917 / O	02800917 / O	02800917 / O	02800917 / O	02800917 / O
02800905* / ●	02800976 / ●	02800905* / ●	02800905* / ●	02800905* / ●	02800905* / ●	02800905* / ●	02800905* / ●	02800905* / ●	02800905* / ●	02800905* / ●	02800905* / ●
02800918 / O	-	02800918 / O	02800918 / O	02800918 / O	02800918 / O	02800918 / O	02800918 / O	02800918 / O	02800922-0280092 / O	02800922-02800927 / O	02800922-02800927 / O
02859391 / O	02859492 / O	02859391 / O	02859391 / O	02859391 / O	02859391 / O	02859391 / O	02859391 / O	02859391 / O	02859489 / O	02859489 / O	02859489 / O
02893002 / O	-	02893002 / O	02893002 / O	02893002 / O	02893002 / O	02893002 / O	02893002 / O	02893002 / O	02893002 / O	02893002 / O	02893002 / O

Code	02061608	02061405	02061105	02088307	02063399	02061399	02061799	02149402
EAN	8422248371209	8422248357074	8422248357081	8422248371216	8422248095303	8422248095273	8422248110198	8422248084161
Model	VK 6000 X +FCA	VK 6000 BK	VK 6000 WH	VK 5000 X	V3-T900 X	V3-T600 X	V3-T600 WH	Q-7790 BK
Type	Chimney	Chimney	Chimney	Chimney	Chimney	Chimney	Chimney	Chimney
Product fiche according to directives EU65/2014 - EN61591, EN60704-2-13, EN50564								
AEC (Annual Energy consumption) (kWh/annum)	24,8	24,8	24,8	24,8	29,8	29,8	29,8	95,7
EEL class (Energy Efficiency Class)	A	A	A	A	B	B	B	C
FDE (Fluid Dynamic Efficiency)	28,5	28,5	28,5	28,5	13,9	13,9	13,9	17,8
FDE class (Fluid Dynamic Efficiency Class)	B	B	B	B	D	D	D	D
LE (Lighting Efficiency) (lux/W)	31,6	31,6	31,6	31,6	35	44	44	36
LE class (Lighting Efficiency Class)	A	A	A	A	A	A	A	A
GFE (Grease Filtering Efficiency)	71,4	71,4	71,4	71,4	65,3	65,3	65,3	90,3
GFE Class (Grease Filtering Efficiency class)	D	D	D	D	D	D	D	B
Air flow at minimum speed (m³/h)	175	175	175	175	166,7	166,7	166,7	385
Air flow at maximum speed (m³/h)	480	480	480	480	335,8	335,8	335,8	645
Air flow at intensive speed (TURBO) (m³/h)	-	-	-	-	-	-	-	-
Sound Power Level at minimum speed (dB)	56	56	56	56	51	51	51	58
Sound Power Level at maximum speed (dB)	67	67	67	67	66	66	66	72
Sound Power Level at intensive speed (TURBO) (dB)	-	-	-	-	-	-	-	-
Po (Power Consumption in off mode) (W)	0	0	0	0	0	0	0	0
Ps (Power Consumption in standby) (W)	-	-	-	-	-	-	-	0
Integration directive EU 66/2014								
f (Time Increase Factor)	1	1	1	1	1,5	1,5	1,5	1,4
EEL (Energy Efficiency Index)	48,5	48,5	48,5	48,5	66,4	66,4	66,4	80,1
Q _{SEP} (Flow Rate at Best Efficiency Point) (m³/h)	255,1	255,1	255,1	255,1	202,1	202,1	202,1	371,8
P _{SEP} (Static Pressure Difference at Best Efficiency Point) (Pa)	249,1	249,1	249,1	249,1	129	129	129	314
W _{SEP} (Electric Power Input at Best Efficiency Point) (W)	62	62	62	62	52,1	52,1	52,1	182,5
W _i (Nominal Power Consumption of Lighting system) (W)	3	3	3	3	1,7	1,7	1,7	7
E _{MINI} (Average Illumination of Lighting system on Cooking surface) (lux)	95	95	95	95	63	74	74	252
External Dimensions								
Width (mm)	600	600	600	500	895	595	595	900
Depth (mm)	475	475	475	475	480	480	480	560
Total max height (mm)	910	910	910	910	923	923	923	1140
Total min height (mm)	670	670	670	670	573	573	573	720
Outlet Diameter (mm)	150/120	150/120	150/120	150/120	150	150	150	150
Characteristics								
Motor	K10	K10	K10	K10	TT300	TT300	TT300	M3R
Extraction Levels	3	3	3	3	5+1	5+1	5+1	3
Maximum Power Consumption	110	110	110	110	65	65	65	270
Maximum Pressure	290,8	290,8	290,8	290,8	177	177	177	430
Intensive Speed (TURBO) Pressure	-	-	-	-	-	-	-	-
Control Type	Mechanic	Mechanic	Mechanic	Mechanic	Mechanic	Mechanic	Mechanic	Mechanic
Connectivity	-	-	-	-	-	-	-	-
Automatic removal	-	-	-	-	-	-	-	-
Automatic shut-down timer	-	-	-	-	-	-	-	-
Electronic Filter Saturation Indicator	-	-	-	-	-	-	-	-
Filter Type/ layers	Metallic	Metallic	Metallic	Metallic	Metallic	Metallic	Metallic	Metallic, 4 layers
Anti-grease Filter Number	2	2	2	1	3	3	3	2
Inner Shield	-	-	-	-	-	-	-	-
Glass damped open/closure	-	-	-	-	-	-	-	-
Air purification function	-	-	-	-	-	-	-	-
Air quality sensor	-	-	-	-	-	-	-	-
Anti-drip system	-	-	-	-	-	-	-	-
Lighting								
Light Type	CSLED	CSLED	CSLED	CSLED	CSLED	CSLED	CSLED	EcoLed
Adjustable Intensity Lighting	-	-	-	-	-	-	-	-
Colour temperature	-	-	-	-	-	-	-	-
N° of Lamps	1	1	1	1	1	1	1	2
Installation								
Minimum height distance to a electric worktop hob (mm)	650	650	650	650	650	650	650	650
Minimum height distance to a gas worktop hob (mm)	650	650	650	650	650	650	650	650
Installation with Outlet tube to the exterior / Recirculating	BOTH	BOTH	BOTH	BOTH	BOTH	BOTH	BOTH	BOTH
Easy Installation System	√	√	√	√	√	√	√	√
Electric Connection								
Total Rush Power (W)	113	113	113	113	67	67	67	277
Rated Voltage (V)	220-240	220-240	220-240	220-240	220-240	220-240	220-240	220-240
Network Frequency (Hz)	50	50	50	50	50	50	50	50
Electrical Insulation Class	CLASS II	CLASS II	CLASS II	CLASS II	CLASS I	CLASS I	CLASS I	CLASS II
Plug	-	-	-	-	VDE	VDE	VDE	EU - 2 pins
Accessories / ○ NOT INCLUDED ● INCLUDED								
Upper Decorative tube Extension	02862302 / ○	-	-	02862302 / ○	-	-	-	02885400 / ○
White Decorative Tube	-	-	-	-	-	-	-	-
Black Decorative Tube	-	-	-	-	-	-	-	-
Island Tube Enhancer	-	-	-	-	-	-	-	-
Check Valve	02832004 / ○	02832004 / ○	02832004 / ○	02832004 / ○	-	-	-	02832001 / ○
MAX PRO Metal Filter	02800917 / ○	02800917 / ○	02800917 / ○	-	-	-	-	02800917 / ○
Metal Filter	02800905* / ●	02800905* / ●	02800905* / ●	02813501 / ●	02800995 / ●	02800995 / ●	02800995 / ●	02800905* / ●
DUAL Filter (metal + active charcoal)	02800922-02800927 / ○	02800922-02800927 / ○	02800922-02800927 / ○	-	-	-	-	02800918 / ○
Active Charcoal Filter	02859489 / ●	02859489 / ○	02859489 / ○	02859489 / ○	02859495 / ○	02859495 / ○	02859495 / ○	02859391 / ○
Noiseless Flexible Duct	02893002 / ○	02893002 / ○	02893002 / ○	02893002 / ○	02893002 / ○	02893002 / ○	02893002 / ○	02893002 / ○
Top outlet motor cover	-	-	-	-	-	-	-	-
FCA kit without duct cover	-	-	-	-	-	-	-	-

02148402	02165201	02189005	02181310	02189310	02188310	02186310	02181308	02180308	02189308	02188308	02187308
8422248084178	8422248055529	8422248093729	8422248370783	8422248370776	8422248370769	8422248370752	8422248110556	8422248198547	8422248110549	8422248110532	8422248110525
Q-7760 BK	CHORUS XBK	TENTA 90 GWH	CORONA X NO DRIP 120	CORONA X NO DRIP 90	CORONA X NO DRIP 80	CORONA X NO DRIP 60	CORONA X 120	CORONA X 100	CORONA X 90	CORONA 80	CORONA X 70
Chimney	MW Box	Integrated	Integrated	Integrated	Integrated	Integrated	Integrated	Integrated	Integrated	Integrated	Integrated
95,7	49	24,7	57,1	54,9	54,9	54,9	51,9	51,9	51,9	51,9	51,9
C	C	A+	A	A	A	A	A	A	A	A	A
17,8	9,8	37,5	29,2	29,2	29,2	29,2	30,6	30,6	30,6	30,6	30,6
D	E	A	A	A	A	A	A	A	A	A	A
36	36	23,7	16,1	22,3	22,3	22,3	22,3	22,3	22,3	22,3	22,3
A	A	B	C	B	B	B	B	B	B	B	B
90,3	74,6	85,79	69,5	69,5	69,5	69,5	84,2	84,2	84,2	84,2	84,2
B	D	B	D	D	D	D	C	C	C	C	C
385	210	245	272,4	272,4	272,4	272,4	340	340	340	340	340
645	400	509,4	608,9	608,9	608,9	608,9	600	600	600	600	600
-	-	765,3	766	766	766	766	850	850	850	850	850
58	50	46	54	54	54	54	50	50	50	50	50
72	62	63	69	69	69	69	65	65	65	65	65
-	-	67	71	71	71	71	67	67	67	67	67
0	0	0,49	0,48	0,48	0,48	0,48	0,26	0,26	0,26	0,26	0,26
0	0	0	-	-	-	-	0	0	0	0	0
1,4	1,6	0,7	0,9	0,9	0,9	0,9	0,9	0,9	0,9	0,9	0,9
80,1	82,6	40,3	53,4	52,2	52,2	52,2	53,3	53,3	53,3	53,3	53,3
371,8	208,6	346,6	437,8	437,8	437,8	437,8	416,9	416,9	416,9	416,9	416,9
314	123	298	385	385	385	385	411	411	411	411	411
182,5	72,9	76,6	160,5	160,5	160,5	160,5	155,7	155,7	155,7	155,7	155,7
7	7	7	6	3	3	3	6	3	3	3	3
252	252	166	96,6	67	67	67	96,6	67	67	67	67
600	598	900	1195	895	795	595	1195	995	895	795	695
560	470	310-350	310-350	310-350	310-350	310-350	310-350	310-350	310-350	310-350	310-350
1110	1140	331	334	334	334	334	339	334	334	334	334
655	775	331	334	334	334	334	339	334	334	334	334
150	150	150	150	150	150	150	150	150	150	150	150
M3R	K7 PLUS	BT4DC	BT5 AC 800	BT5 AC 800	BT5 AC 800	BT5 AC 800	BT3	BT3	BT3	BT3	BT3
3	3	5+1	3+1	3+1	3+1	3+1	3+1	3+1	3+1	3+1	3+1
270	95	135	280	280	280	280	280	280	280	280	280
430	200	357	450	450	450	450	450	450	450	450	450
-	-	365	470	470	470	470	470	470	470	470	470
Mechanic	Mechanic	TCD6I	SDX6I	SDX6I	SDX6I	SDX6I	VL4i	VL4i	VL4i	VL4i	VL4i
-	-	AUTO 2	AUTO 2	AUTO 2	AUTO 2	AUTO 2	-	-	-	-	-
-	-	-	-	-	-	-	-	-	-	-	-
-	-	√	√	√	√	√	√	√	√	√	√
-	-	√	√	√	√	√	-	-	-	-	-
Metallic, 4 layers	Metallic, 4 layers	Metallic, 5 layers	Decorative stainless steel, 5 layers	Decorative stainless steel, 5 layers	Decorative stainless steel, 5 layers	Decorative stainless steel, 5 layers	Decorative stainless steel, 6 layers	Decorative stainless steel, 6 layers	Decorative stainless steel, 6 layers	Decorative stainless steel, 6 layers	Decorative stainless steel, 6 layers
2	2	3	4	3	2	2	2	2	2	2	2
-	-	-	-	-	-	-	-	-	-	-	-
-	-	√	√	√	√	√	√	√	√	√	√
-	-	√	√	√	√	√	-	-	-	-	-
-	-	-	-	-	-	-	-	-	-	-	-
-	-	-	Removable tank	Removable tank	Removable tank	Removable tank	-	-	-	-	-
EcoLed	EcoLed	SS Led	SS Led	SS Led	SS Led	SS Led	SS Led	SS Led	SS Led	SS Led	SS Led
-	-	√	√	√	√	√	√	√	√	√	√
-	-	Warm 2700°K / White 4000°K	White 4000°K	White 4000°K	White 4000°K	White 4000°K	White 4000°K	White 4000°K	White 4000°K	White 4000°K	White 4000°K
2	2	1	2	1	1	1	2	1	1	1	1
650	592	550	550	550	550	550	550	550	550	550	550
650	692	650	650	650	650	650	650	650	650	650	650
BOTH	BOTH	BOTH	BOTH	BOTH	BOTH	BOTH	BOTH	BOTH	BOTH	BOTH	BOTH
√	√	√	√	√	√	√	√	√	√	√	√
277	102	146	286	283	283	283	286	283	283	283	283
220-240	220-240	220-240	220-240	220-240	220-240	220-240	220-240	220-240	220-240	220-240	220-240
50	50	50-60	(220)-50-60/ (240)-50	(220)-50-60/ (240)-50	(220)-50-60/ (240)-50	(220)-50-60/ (240)-50	50	50	50	50	50
CLASS II	CLASS II	CLASS I	CLASS II	CLASS II	CLASS II	CLASS II	CLASS II	CLASS II	CLASS II	CLASS II	CLASS II
EU - 2 pins	EU - 2 pins	-	-	-	-	-	-	-	-	-	-
02861306 / O	-	-	02861306 / O	02861306 / O	02861306 / O	02861306 / O	02861306 / O	02861306 / O	02861306 / O	02861306 / O	02861306 / O
-	-	-	-	-	-	-	-	-	-	-	-
-	-	-	02861307 / O	02861307 / O	02861307 / O	02861307 / O	02861307 / O	02861307 / O	02861307 / O	02861307 / O	02861307 / O
-	-	-	-	-	-	-	-	-	-	-	-
02832001 / O	02832004 / O	02832008 / O	02832004 / O	02832004 / O	02832004 / O	02832004 / O	02832004 / O	02832004 / O	02832004 / O	02832004 / O	02832004 / O
-	02800917 / O	-	-	-	-	-	-	-	-	-	-
02800940 / ●	02800905' / ●	02811000' / ●	02800217' / ●	02800217' / ●	02800217' / ●	02800217' / ●	02800205 / ●	02800205 / ●	02800205 / ●	02800210 / ●	02800943 / ●
-	02800918 / O	02811003' / O	-	-	-	-	-	-	-	-	-
02859391 / O	02859394 / O	02859318 / O	02859398 / O	02859398 / O	02859398 / O	02859398 / O	02859398 / O	02859398 / O	02859398 / O	02859398 / O	02859398 / O
02893002 / O	02893002 / O	02893002 / O	02893002 / O	02893002 / O	02893002 / O	02893002 / O	02893002 / O	02893002 / O	02893002 / O	02893002 / O	02893002 / O
-	-	-	02800013 / ●	02800013 / ●	02800013 / ●	02800013 / ●	-	-	-	-	-

Code	02186308	02189400	02186400	02186010	02189311	02189411	02186311	02186411
EAN	8422248110518	8422248348782	8422248198257	8422248355216	8422248372121	8422248372138	8422248372152	8422248372145
Model	CORONA X 60	CORONA BK 90 / B	CORONA BK 60	CORONA WH 60	ARONA 90 X	ARONA 90 BK	ARONA 60 X	ARONA 60 BK
Type	Integrated	Integrated	Integrated	Integrated	Integrated	Integrated	Integrated	Integrated
Product fiche according to directives EU65/2014 - EN61591, EN60704-2-13, EN50564								
AEC (Annual Energy consumption) (kWh/annum)	51,9	51,9	51,9	51,9	54,9	54,9	54,9	54,9
EEL class (Energy Efficiency Class)	A	A	A	A	A	A	A	A
FDE (Fluid Dynamic Efficiency)	30,6	30,6	30,6	30,6	29,2	29,2	29,2	29,2
FDE class (Fluid Dynamic Efficiency Class)	A	A	A	A	A	A	A	A
LE (Lighting Efficiency) (lux/W)	22,3	22,3	22,3	22,3	23,7	22,7	23,7	23,7
LE class (Lighting Efficiency Class)	B	B	B	B	B	B	B	B
GFE (Grease Filtering Efficiency)	84,2	84,2	84,2	84,2	93,5	93,5	93,5	93,5
GFE Class (Grease Filtering Efficiency class)	C	C	C	C	B	B	B	B
Air flow at minimum speed (m³/h)	340	340	340	340	272,4	272,4	272,4	272,4
Air flow at maximum speed (m³/h)	600	600	600	600	608,9	608,9	608,9	608,9
Air flow at intensive speed (TURBO) (m³/h)	850	850	850	850	766,0	766,0	766,0	766,0
Sound Power Level at minimum speed (dB)	50	50	50	50	54	54	54	54
Sound Power Level at maximum speed (dB)	65	65	65	65	69	69	69	69
Sound Power Level at intensive speed (TURBO) (dB)	67	67	67	67	71	71	71	71
Po (Power Consumption in off mode) (W)	0,26	0,26	0,26	0,26	0,39	0,39	0,39	0,39
Ps (Power Consumption in standby) (W)	0	0	0	0	-	-	-	-
Integration directive EU 66/2014								
f (Time Increase Factor)	0,9	0,9	0,9	0,9	0,9	0,9	0,9	0,9
EEL (Energy Efficiency Index)	53,3	53,3	53,3	53,3	52,2	52,2	52,2	52,2
Q _{best} (Flow Rate at Best Efficiency Point) (m³/h)	416,9	416,9	416,9	416,9	437,8	437,8	437,8	437,8
P _{best} (Static Pressure Difference at Best Efficiency Point) (Pa)	411	411	411	411	385	385	385	385
W _{best} (Electric Power Input at Best Efficiency Point) (W)	155,7	155,7	155,7	155,7	160,5	160,5	160,5	160,5
W _n (Nominal Power Consumption of Lighting system) (W)	3	3	3	3	3	3	3	3
E _{min} (Average Illumination of Lighting system on Cooking surface) (lux)	67	67	67	67	71	71	71	71
External Dimensions								
Width (mm)	595	895	595	595	895	895	595	595
Depth (mm)	310-350	310-350	310-350	310-350	310-350	310-350	310-350	310-350
Total max height(mm)	334	334	334	334	334	334	334	334
Total min height(mm)	334	334	334	334	334	334	334	334
Outlet Diameter (mm)	150	150	150	150	150	150	150	150
Characteristics								
Motor	BT3	BT3	BT3	BT3	BT5 AC 800	BT5 AC 800	BT5 AC 800	BT5 AC 800
Extraction Levels	3+1	3+1	3+1	3+1	3+1	3+1	3+1	3+1
Maximum Power Consumption	280	280	280	280	280	280	280	280
Maximum Pressure	450	450	450	450	473,7	473,7	473,7	473,7
Intensive Speed (TURBO) Pressure	470	470	470	470	508,3	508,3	508,3	508,3
Control Type	VL4i	VL4i	VL4i	VL4i	SDX6i	SDX6i	SDX6i	SDX6i
Connectivity	-	-	-	-	AUTO 2	AUTO 2	AUTO 2	AUTO 2
Automatic removal	-	-	-	-	-	-	-	-
Automatic shut-down timer	√	√	√	√	√	√	√	√
Electronic Filter Saturation Indicator	-	-	-	-	-	-	-	-
Filter Type/ layers	Decorative stainless steel, 6 layers	Decorative stainless steel, 6 layers	Decorative stainless steel, 6 layers	Decorative stainless steel, 6 layers	Metallic, 12 layers	Black metallic, 12 layers	Metallic, 12 layers	Black metallic, 12 layers
Anti-grease Filter Number	2	2	2	2	3	3	2	2
Inner Shield	-	-	-	-	-	-	-	-
Glass damped open/closure	√	√	√	√	√	√	√	√
Air purification function	-	-	-	-	√	√	√	√
Air quality sensor	-	-	-	-	-	-	-	-
Anti-drip system	-	-	-	-	-	-	-	-
Lighting								
Light Type	SS Led	SS Led	SS Led	SS Led	SS Led	SS Led	SS Led	SS Led
Adjustable Intensity Lighting	√	√	√	√	√	√	√	√
Colour temperature	White 4000°K	White 4000°K	White 4000°K	White 4000°K	Warm 2700°K / White 4000°K	Warm 2700°K / White 4000°K	Warm 2700°K / White 4000°K	Warm 2700°K / White 4000°K
N° of Lamps	1	1	1	1	1	1	1	1
Installation								
Minimum height distance to a electric worktop hob (mm)	550	550	550	550	550	550	550	550
Minimum height distance to a gas worktop hob (mm)	650	650	650	650	650	650	650	650
Installation with Outlet tube to the exterior / Recirculating	BOTH	BOTH	BOTH	BOTH	BOTH	BOTH	BOTH	BOTH
Easy Installation System	√	√	√	√	√	√	√	√
Electric Connection								
Total Rush Power (W)	283	283	283	283	283	283	283	283
Rated Voltage (V)	220-240	220-240	220-240	220-240	220-240	220-240	220-240	220-240
Network Frequency (Hz)	50	50	50	50	50	50	50	50
Electrical Insulation Class	CLASS II	CLASS II	CLASS II	CLASS II	CLASS II	CLASS II	CLASS II	CLASS II
Plug	-	-	-	-	-	-	-	-
Accessories / ○ NOT INCLUDED ● INCLUDED								
Upper Decorative tube Extension	02861306 / ○	02861306 / ○	02861306 / ○	02861306 / ○	02861306 / ○	02861306 / ○	02861306 / ○	02861306 / ○
White Decorative Tube	-	-	-	-	-	-	-	-
Black Decorative Tube	02861307 / ○	02861307 / ○	02861307 / ○	02861307 / ○	02861307 / ○	02861307 / ○	02861307 / ○	02861307 / ○
Island Tube Enhancer	-	-	-	-	-	-	-	-
Check Valve	02832004 / ○	02832004 / ○	02832004 / ○	02832004 / ○	02832004 / ○	02832004 / ○	02832004 / ○	02832004 / ○
MAX PRO Metal Filter	-	-	-	-	-	-	-	-
Metal Filter	02800205 / ●	02800205 / ●	02800205 / ●	02800205 / ●	02801020 / ●	02801025 / ●	02801020 / ●	02801025 / ●
DUAL Filter (metal + active charcoal)	-	-	-	-	02801035 / ○	02801030 / ○	02801035 / ○	02801030 / ○
Active Charcoal Filter	02859398 / ○	02859398 / ○	02859398 / ○	02859398 / ○	02859398 / ○	02859398 / ○	02859398 / ○	02859398 / ○
Noiseless Flexible Duct	02893002 / ○	02893002 / ○	02893002 / ○	02893002 / ○	02893002 / ○	02893002 / ○	02893002 / ○	02893002 / ○
Top outlet motor cover	-	-	-	-	-	-	-	-
FCA kit without duct cover	-	-	-	-	02800013 / ●	02800013 / ●	02800013 / ●	02800013 / ●

02189309	02188309	02187309	02187409	02186409	02186309	02184309	02131207	02130207	02131208	02130208	02031308
8422248110587	8422248356022	8422248351928	8422248356015	8422248355995	8422248110570	8422248110563	8422248078313	8422248078290	8422248078320	8422248078306	8422248103589
ARMONIA 90 X	ARMONIA 80 X	ARMONIA 70 X	ARMONIA 70 BK	ARMONIA 60 BK	ARMONIA 60 X	ARMONIA 45 X	GC DUAL 75 WH	GC DUAL 45 WH	GC DUAL 75 BK	GC DUAL 45 BK	GCX 83 SD
Integrated	Integrated	Integrated	Integrated	Integrated	Integrated	Integrated	Canopy	Canopy	Canopy	Canopy	Canopy
100,9	100,9	100,9	100,9	100,9	100,9	100,9	58,3	58,3	58,3	58,3	56,1
C	C	C	C	C	C	C	A	A	A	A	A
16,3	16,3	16,3	16,3	16,3	16,3	16,3	30,2	30,2	30,2	30,2	30,2
D	D	D	D	D	D	D	A	A	A	A	A
21,4	21,4	21,4	21,4	21,4	21,4	21,4	16,1	16,1	16,1	16,1	26
B	B	B	B	B	B	B	C	C	C	C	B
88,5	88,5	88,5	88,5	88,5	88,5	88,5	91,2	91,2	91,2	91,2	91,2
B	B	B	B	B	B	B	B	B	B	B	B
385	385	385	385	385	385	385	340	340	340	340	340
645	645	645	645	645	645	645	600	600	600	600	600
-	-	-	-	-	-	-	820	820	820	820	750
56	56	56	56	56	56	56	50	50	50	50	50
70	70	70	70	70	70	70	65	65	65	65	65
-	-	-	-	-	-	-	67	67	67	67	67
0	0	0	0	0	0	0	0,3	0,3	0,3	0,3	0,3
0	0	0	0	0	0	0	0	0	0	0	0
1,4	1,4	1,4	1,4	1,4	1,4	1,4	0,9	0,9	0,9	0,9	0,9
82,4	82,4	82,4	82,4	82,4	82,4	82,4	54,4	54,4	54,4	54,4	54,4
375,3	375,3	375,3	375,3	375,3	375,3	375,3	429,4	429,4	429,4	429,4	429,4
295	295	295	295	295	295	295	405	405	405	405	405
188,8	188,8	188,8	188,8	188,8	188,8	188,8	159,8	159,8	159,8	159,8	159,8
6	6	6	6	6	6	6	7	7	7	7	7
128,3	128,3	128,3	128,3	128,3	128,3	128,3	113	113	113	113	170
898	798	698	698	598	598	447	792	492	792	492	830
310-350	310-350	310-350	310-350	310-350	310-350	310-350	277	277	277	277	280
280	280	280	280	280	280	280	300	300	300	300	316
280	280	280	280	280	280	280	300	300	300	300	316
150	150	150	150	150	150	150	150	150	150	150	150
M3R	M3R	M3R	M3R	M3R	M3R	M3R	BT3	BT3	BT3	BT3	BT3
3	3	3	3	3	3	3	4+1	4+1	4+1	4+1	5+1
270	270	270	270	270	270	270	280	280	280	280	280
430	430	430	430	430	430	430	450	450	450	450	450
-	-	-	-	-	-	-	470	470	470	470	470
Mechanic	Mechanic	Mechanic	Mechanic	Mechanic	Mechanic	Mechanic	TC4i	TC4i	TC4i	TC4i	TC4i
-	-	-	-	-	-	-	-	-	-	-	-
-	-	-	-	-	-	-	-	-	-	-	-
-	-	-	-	-	-	-	√	√	√	√	√
-	-	-	-	-	-	-	√	√	√	√	√
Metallic, 4 layers	Metallic, 4 layers	Metallic, 4 layers	Metallic, 4 layers	Metallic, 4 layers	Metallic, 4 layers	Metallic, 4 layers	Metallic, 6 layers	Metallic, 6 layers	Metallic, 6 layers	Metallic, 6 layers	Metallic
2	1	1	1	1	1	1	1	1	1	1	2
-	-	-	-	-	-	-	-	-	-	-	-
-	-	-	-	-	-	-	-	-	-	-	-
-	-	-	-	-	-	-	-	-	-	-	-
-	-	-	-	-	-	-	-	-	-	-	-
-	-	-	-	-	-	-	-	-	-	-	-
CSLED	CSLED	CSLED	CSLED	CSLED	CSLED	CSLED	EcoLed	EcoLed	EcoLed	EcoLed	SS Led
-	-	-	-	-	-	-	√	√	√	√	√
White 4000°K	White 4000°K	White 4000°K	White 4000°K	White 4000°K	White 4000°K	White 4000°K					
2	2	2	2	2	2	2	2	2	2	2	1
550	550	550	550	550	550	550	550	550	550	550	550
650	650	650	650	650	650	650	650	650	650	650	650
BOTH	BOTH	BOTH	BOTH	BOTH	BOTH	BOTH	BOTH	BOTH	BOTH	BOTH	BOTH
√	√	√	√	√	√	√	√	√	√	√	√
276	276	276	276	276	276	276	287	287	287	287	285
220-240	220-240	220-240	220-240	220-240	220-240	220-240	220-240	220-240	220-240	220-240	220-240
50	50	50	50	50	50	50	50	50	50	50	50
CLASE I	CLASE I	CLASE I	CLASE I	CLASE I	CLASE I	CLASE I	CLASS II	CLASS II	CLASS II	CLASS II	CLASS II
-	-	-	-	-	-	-	EU - 2 pins	EU - 2 pins	EU - 2 pins	EU - 2 pins	EU - 2 pins
02861306 / O	02861306 / O	02861306 / O	02861307 / O	02861307 / O	02861306 / O	02861306 / O	-	-	-	-	-
-	-	-	-	-	-	-	-	-	-	-	-
02861307 / O	02861307 / O	02861307 / O	02861307 / O	02861307 / O	02861307 / O	02861307 / O	-	-	-	-	-
-	-	-	-	-	-	-	-	-	-	-	-
02832001 / O	02832001 / O	02832001 / O	02832001 / O	02832001 / O	02832001 / O	02832001 / O	02832004 / O	02832004 / O	02832004 / O	02832004 / O	02832004 / O
-	-	-	-	-	-	-	-	-	-	-	-
02800212 / ●	02800212 / ●	02800212 / ●	02800212 / ●	02800211 / ●	02800211 / ●	02800211 / ●	02800903 / ●	02800904 / ●	02800903 / ●	02800904 / ●	65300315 / ●
02800215 / O	02801003 / O	02801003 / O	02801003 / O	02800216 / O	02800216 / O	02800215 / O	-	02800938 / O	-	02800938 / O	-
02859398 / O	02859398 / O	02859398 / O	02859398 / O	02859398 / O	02859398 / O	02859398 / O	02859398 / O	02859398 / O	02859398 / O	02859398 / O	02859392 / O
02893002 / O	02893002 / O	02893002 / O	02893002 / O	02893002 / O	02893002 / O	02893002 / O	02893002 / O	02893002 / O	02893002 / O	02893002 / O	02893002 / O

Code	02030308	02031302	02030305	02031301	02030309	02030408	02030005	02031300
EAN	8422248103572	8422248190411	8422248077842	8422248190381	8422248190374	8422248190404	8422248190398	8422248108461
Model	GCX 53 SD	GL 75 X	GL 45 X	GT-PLUS 75 X / M	GT-PLUS 45 X / M	GT-PLUS 45 BK / M	GT-PLUS 45 WH / M	GCB 73 X
Type	Canopy	Canopy	Canopy	Canopy	Canopy	Canopy	Canopy	Canopy
Product fiche according to directives EU65/2014 - EN61591, EN60704-2-13, EN50564								
AEC (Annual Energy consumption) (kWh/annum)	56,1	58,3	58,3	88,6	88,6	88,6	88,6	47
EEL class (Energy Efficiency Class)	A	A	A	C	C	C	C	C
FDE (Fluid Dynamic Efficiency)	30,2	30,2	30,2	16,3	16,3	16,3	16,3	13,2
FDE class (Fluid Dynamic Efficiency Class)	A	A	A	D	D	D	D	D
LE (Lighting Efficiency) (lux/W)	26	24,3	24,3	28,3	33,7	33,7	33,7	40,2
LE class (Lighting Efficiency Class)	B	B	B	A	A	A	A	A
GFE (Grease Filtering Efficiency)	91,2	91,2	91,2	91,2	91,2	91,2	91,2	80
GFE Class (Grease Filtering Efficiency class)	B	B	B	B	B	B	B	C
Air flow at minimum speed (m³/h)	340	340	340	300	300	300	300	219,2
Air flow at maximum speed (m³/h)	600	600	600	645	645	645	645	355,1
Air flow at intensive speed (TURBO) (m³/h)	750	850	850	-	-	-	-	-
Sound Power Level at minimum speed (dB)	50	50	50	50	50	50	50	49,1
Sound Power Level at maximum speed (dB)	65	65	65	65	65	65	65	63,6
Sound Power Level at intensive speed (TURBO) (dB)	67	67	67	-	-	-	-	-
Po (Power Consumption in off mode) (W)	0,3	0,3	0,3	0	0	0	0	0
Ps (Power Consumption in standby) (W)	0	0	0	0	0	0	0	0
Integration directive EU 66/2014								
f (Time Increase Factor)	0,9	0,9	0,9	1,4	1,4	1,4	1,4	1,52
EEL (Energy Efficiency Index)	54,4	54,4	54,4	81,1	81,1	81,1	81,1	76,8
Q _{SEP} (Flow Rate at Best Efficiency Point) (m³/h)	429,4	429,4	429,4	358,1	358,1	358,1	358,1	218,2
P _{SEP} (Static Pressure Difference at Best Efficiency Point) (Pa)	405	405	405	270	270	270	270	174
W _{SEP} (Electric Power Input at Best Efficiency Point) (W)	159,8	159,8	159,8	164,9	164,9	164,9	164,9	79,7
W _i (Nominal Power Consumption of Lighting system) (W)	7	7	7	6	6	6	6	3
E _{MINI} (Average Illumination of Lighting system on Cooking surface) (lux)	170	170	170	170	202	202	202	120,6
External Dimensions								
Width (mm)	530	792	492	792	492	492	492	730
Depth (mm)	253	277	277	277	277	277	277	310
Total max height (mm)	316	315	280	312	282	282	282	187
Total min height (mm)	316	315	280	312	282	282	282	187
Outlet Diameter (mm)	150	150	150	150	150	150	150	150
Characteristics								
Motor	BT3	BT3	BT3	BT2	BT2	BT2	BT2	100W
Extraction Levels	5+1	5+1	5+1	5+1	5+1	5+1	5+1	3
Maximum Power Consumption	280	280	280	200	200	200	200	104,6
Maximum Pressure	450	450	450	400	400	400	400	250
Intensive Speed (TURBO) Pressure	470	470	470	-	-	-	-	-
Control Type	TC4i	TC4i	TC4i	Mechanic	Mechanic	Mechanic	Mechanic	Mechanic
Connectivity	-	-	-	-	-	-	-	-
Automatic removal	-	-	-	-	-	-	-	-
Automatic shut-down timer	√	√	√	-	-	-	-	-
Electronic Filter Saturation Indicator	√	√	√	-	-	-	-	-
Filter Type/ layers	Metallic	Metallic	Metallic	Metallic	Metallic	Metallic	Metallic	Metallic
Anti-grease Filter Number	2	3	2	2	2	2	2	2
Inner Shield	-	-	-	-	-	-	-	-
Glass damped open/closure	-	-	-	-	-	-	-	-
Air purification function	-	-	-	-	-	-	-	-
Air quality sensor	-	-	-	-	-	-	-	-
Anti-drip system	-	-	-	-	-	-	-	-
Lighting								
Light Type	SS Led	EcoLed	EcoLed	CSLED	CSLED	CSLED	CSLED	CSLED
Adjustable Intensity Lighting	√	√	√	-	-	-	-	-
Colour temperature	-	-	-	-	-	-	-	-
N° of Lamps	1	2	2	2	2	2	2	1
Installation								
Minimum height distance to a electric worktop hob (mm)	550	550	550	550	550	550	550	550
Minimum height distance to a gas worktop hob (mm)	650	650	650	650	650	650	650	650
Installation with Outlet tube to the exterior / Recirculating	BOTH	BOTH	BOTH	BOTH	BOTH	BOTH	BOTH	BOTH
Easy Installation System	√	√	√	√	√	√	√	√
Electric Connection								
Total Rush Power (W)	285	287	287	206	206	206	206	107,6
Rated Voltage (V)	220-240	220-240	220-240	220-240	220-240	220-240	220-240	220-240
Network Frequency (Hz)	50	50	50	50	50	50	50	50
Electrical Insulation Class	CLASS II	CLASS II	CLASS II	CLASS II	CLASS II	CLASS II	CLASS II	CLASS I
Plug	EU - 2 pins	EU - 2 pins	EU - 2 pins	EU - 2 pins	EU - 2 pins	EU - 2 pins	EU - 2 pins	-
Accessories / ○ NOT INCLUDED ● INCLUDED								
Upper Decorative tube Extension	-	-	-	-	-	-	-	-
White Decorative Tube	-	-	-	-	-	-	-	-
Black Decorative Tube	-	-	-	-	-	-	-	-
Island Tube Enhancer	-	-	-	-	-	-	-	-
Check Valve	02832004 / ○	02832004 / ○	02832004 / ○	02832004 / ○	02832004 / ○	02832004 / ○	02832004 / ○	-
MAX PRO Metal Filter	-	-	-	-	-	-	-	-
Metal Filter	65300310 / ●	02800996 / ●	02811000* / ●	02811000* / ●	02811000* / ●	02811000* / ●	02811000* / ●	02800988 / ●
DUAL Filter (metal + active charcoal)	-	-	02811003* / ○	02811003* / ○	02811003* / ○	02811003* / ○	02811003* / ○	-
Active Charcoal Filter	02859392 / ○	02859398 / ○	02859398 / ○	02859398 / ○	02859398 / ○	02859398 / ○	02859398 / ○	02859500 / ○
Noiseless Flexible Duct	02893002 / ○	02893002 / ○	02893002 / ○	02893002 / ○	02893002 / ○	02893002 / ○	02893002 / ○	02893002 / ○
Top outlet motor cover	-	-	-	-	-	-	-	-
FCA kit without duct cover	-	-	-	-	-	-	-	-

02030300	02130302	02039306	02039308	02039007	02094307	02089307	02010601	02010101	02010404	02010300	02010302
8422248108454	8422248082716	8422248357135	8422248371278	8422248357142	8422248371285	8422248371292	8422248112741	8422248112758	8422248357364	8422248082365	8422248082402
GCB 55 X	G 50 LUX X	GK 4500 X	GK 4500 X +FCA	GK 4500 WH	TFH 9830 X	TFH 7430 GBK	TFH 6830 X	TFH 6830 GWH	TFH 6830 GBK	TFH 6630 X	TFH 6630 BK
Canopy	Canopy	Canopy	Canopy	Canopy	Telescopic	Telescopic	Telescopic	Telescopic	Telescopic	Telescopic	Telescopic
47	49	29,7	29,7	29,7	16,6	13,4	16,6	16,6	16,6	19,3	19,3
C	C	B	B	B	A+++	A+	A+++	A+++	A+++	A+	A+
13,1	9,8	19,3	19,3	19,3	41,11	24,9	41,11	41,11	41,11	34,4	34,4
D	E	C	C	C	A	B	A	A	A	A	A
39,8	36	15,5	15,5	15,5	22,6	18	22,6	22,6	22,6	21,9	21,9
A	A	D	D	D	B	C	B	B	B	B	B
77,8	74,6	63	63	63	66,4	79,9	66,4	66,4	66,4	66,4	66,4
C	D	E	E	E	D	C	D	D	D	D	D
216,2	210	190	190	190	291	164,1	291	291	291	210	210
351	400	360	360	360	600	320,4	600	600	600	410	410
-	-	-	-	-	795	391,5	795	795	795	585	585
49,2	50	56	56	56	46	44	46	46	46	47	47
63,3	62	67	67	67	64	62	64	64	64	64	64
-	-	-	-	-	69	65	69	69	69	70	70
0	0	0	0	0	0,3	0,45	0,3	0,3	0,3	0,4	0,4
0	0	0	0	0	-	-	-	-	-	-	-
1,53	1,6	1,3	1,3	1,3	0,5	1,1	0,5	0,5	0,5	0,8	0,8
76,9	82,6	60,7	60,7	60,7	27,5	41,5	27,5	27,5	27,5	39,2	39,2
215,6	208,6	199,7	199,7	199,7	332,82	164,6	332,82	332,82	332,82	275,2	275,2
175	123	202	202	202	251,41	152	251,41	251,41	251,41	263	263
80,2	72,9	58	58	58	79,03	27,9	79,03	79,03	79,03	58,6	58,6
3	7	3	3	3	3	3	3	3	3	3	3
119,4	252	46,5	46,5	46,5	79	54	79	79	79	67	67
550	530	510	510	510	900	700	600	600	600	600	600
310	310	302	302	302	300-350	300-350	300-350	300-350	300-350	300-350	300-350
187	172	170	170	170	248	181,5	221,5	221,5	246,5	221,5	182,5
187	172	170	170	170	248	181,5	221,5	221,5	246,5	221,5	182,5
150	150	120	120	120	150	150	150	150	150	150	150
100W	K7 PLUS	K11-360	K11-360	K11-360	BT4DC	EY400	BT4DC	BT4DC	BT4DC	T1DC	T1DC
3	3	2	2	2	5+1	5+1	5+1	5+1	5+1	5+1	5+1
104,1	95	90	90	90	135	55	135	135	135	90	90
250	200	252	252	252	357	243	357	357	357	250	250
-	-	-	-	-	365	362	365	365	365	315	315
Mechanic	Mechanic	Slider	Slider	Slider	TCD6i	TC TFH4i	TCD6i	TCD6i	TCD6i	TCD6i	TCD6i
-	-	-	-	-	-	-	-	-	-	-	-
-	-	-	-	-	√	√	√	√	√	√	√
-	-	-	-	-	√	√	√	√	√	√	√
Metallic	Metallic	Metallic	Metallic	Metallic	Metallic	Metallic	Metallic	Metallic	Metallic	Metallic	Metallic
2	1	1	1	1	4	2	2	2	2	2	2
-	-	-	-	-	-	-	-	-	-	-	-
-	-	-	-	-	-	-	-	-	-	-	-
-	-	-	-	-	-	-	-	-	-	-	-
-	-	-	-	-	-	-	-	-	-	-	-
CSLED	EcoLed	E14 3W	E14 3W	E14 3W	SS Led	SS Led	SS Led	SS Led	SS Led	SS Led	SS Led
-	-	-	-	-	√	√	√	√	√	√	√
1	2	1	1	1	1	1	1	1	1	1	1
550	550	550	550	550	550	550	550	550	550	550	550
650	650	650	650	650	650	650	650	650	650	650	650
BOTH	BOTH	BOTH	BOTH	BOTH	BOTH	BOTH	BOTH	BOTH	BOTH	BOTH	BOTH
√	√	√	√	√	√	√	√	√	√	√	√
107,1	102	93	93	93	138	138	138	138	138	93	93
220-240	220-240	220-240	220-240	220-240	220-240	220-240	220-240	220-240	220-240	220-240	220-240
50	50	50	50	50	50-60	50	50-60	50-60	50-60	50	50
CLASS I	CLASS II	CLASS II	CLASS II	CLASS II	CLASS I	CLASS I	CLASS I	CLASS I	CLASS I	CLASS I	CLASS I
-	EU - 2 pins	-	-	-	-	-	-	-	-	-	-
-	-	-	-	-	-	-	-	-	-	-	-
-	-	-	-	-	-	-	-	-	-	-	-
-	-	-	-	-	-	-	-	-	-	-	-
-	02832004 / O	02849003 / O	02849003 / O	02849003 / O	02832004 / O	02832004 / O	02832004 / O	02832004 / O	02832004 / O	02832004 / O	02832004 / O
-	-	-	-	-	-	-	-	-	-	-	-
02800987 / ●	02832004 / ●	02808000* / ●	02808000* / ●	02808000* / ●	-	-	02825279 / ●	02825279 / ●	02825279 / ●	02825279 / ●	02825279 / ●
-	-	-	-	-	-	-	-	-	-	-	-
02859500 / O	02859394 / O	02859489 / O	02859489 / ●	02859489 / O	02859318 / O	02859394 / O	02859318 / O	02859318 / O	02859318 / O	02859394 / O	02859394 / O
02893002 / O	02893002 / O	-	-	-	02893002 / O	02893002 / O	02893002 / O	02893002 / O	02893002 / O	02893002 / O	02893002 / O

Code	02010301	02010609	02010409	02010009	02017203	02017202	02094305	02089305
EAN	8422248082396	8422248343626	8422248343602	8422248343619	8422248062015	8422248062008	8422248061964	8422248061971
Model	TFH 6630 WH	TFH 6430 X	TFH 6430 GBK	TFH 6430 GWH	TF-2003 600 GBK /B	TF-2003 600 GWH /A	TF-2003 DURALUM 900	TF-2003 DURALUM 700
Type	Telescopic	Telescopic	Telescopic	Telescopic	Telescopic	Telescopic	Telescopic	Telescopic
Product fiche according to directives EU65/2014 - EN61591, EN60704-2-13, EN50564								
AEC (Annual Energy consumption) (kWh/annum)	19,3	13,4	13,4	13,4	44,5	44,5	46,3	44,5
EEL class (Energy Efficiency Class)	A+	A+	A+	A+	C	C	C	C
FDE (Fluid Dynamic Efficiency)	34,4	24,9	24,9	24,9	11,9	11,9	10,1	11,9
FDE class (Fluid Dynamic Efficiency Class)	A	B	B	B	E	E	E	E
LE (Lighting Efficiency) (lux/W)	21,9	18	18	18	36	36	36	36
LE class (Lighting Efficiency Class)	B	C	C	C	A	A	A	A
GFE (Grease Filtering Efficiency)	66,4	79,9	79,9	79,9	68	68	68	68
GFE Class (Grease Filtering Efficiency class)	D	C	C	C	D	D	D	D
Air flow at minimum speed (m³/h)	210	164,1	164,1	164,1	150	150	150	150
Air flow at maximum speed (m³/h)	410	320,4	320,4	320,4	390	390	390	390
Air flow at intensive speed (TURBO) (m³/h)	585	391,5	391,5	391,5	-	-	-	-
Sound Power Level at minimum speed (dB)	47	44	44	44	45	45	45	45
Sound Power Level at maximum speed (dB)	64	62	62	62	57	57	57	57
Sound Power Level at intensive speed (TURBO) (dB)	70	65	65	65	-	-	-	-
Po (Power Consumption in off mode) (W)	0,4	0,45	0,45	0,45	0	0	0	0
Ps (Power Consumption in standby) (W)	-	-	-	-	0	0	0	0
Integration directive EU 66/2014								
f (Time Increase Factor)	0,8	1,1	1,1	1,1	1,6	1,6	1,6	1,6
EEL (Energy Efficiency Index)	39,2	41,5	41,5	41,5	78,2	78,2	81,1	78,2
Q _{SEP} (Flow Rate at Best Efficiency Point) (m³/h)	275,2	164,6	164,6	164,6	198,2	198,2	201,1	198,2
P _{SEP} (Static Pressure Difference at Best Efficiency Point) (Pa)	263	152	152	152	148	148	125	148
W _{SEP} (Electric Power Input at Best Efficiency Point) (W)	58,6	27,9	27,9	27,9	68,6	68,6	69	68,6
W _i (Nominal Power Consumption of Lighting system) (W)	3	3	3	3	7	7	7	7
E _{MINI} (Average Illumination of Lighting system on Cooking surface) (lux)	67	54	54	54	252	252	252	252
External Dimensions								
Width (mm)	600	600	600	600	600	600	900	700
Depth (mm)	300-350	300-350	300-350	300-350	280	280	280	280
Total max height(mm)	221,5	181,5	181,5	181,5	180	180	180	180
Total min height(mm)	221,5	181,5	181,5	181,5	180	180	180	180
Outlet Diameter (mm)	150	150	150	150	150	150	150	150
Characteristics								
Motor	T1DC	EY400	EY400	EY400	TF 2003	TF 2003	TF 2003	TF 2003
Extraction Levels	5+1	5+1	5+1	5+1	5+1	5+1	5+1	5+1
Maximum Power Consumption	90	55	55	55	100	100	100	100
Maximum Pressure	250	243	243	243	194	194	194	194
Intensive Speed (TURBO) Pressure	315	362	362	362	-	-	-	-
Control Type	TCDF6i	TC TFH4i	TC TFH4i	TC TFH4i	Rocker Switch	Rocker Switch	Rocker Switch	Rocker Switch
Connectivity	-	-	-	-	-	-	-	-
Automatic removal	-	-	-	-	-	-	-	-
Automatic shut-down timer	√	√	√	√	-	-	-	-
Electronic Filter Saturation Indicator	√	√	√	√	-	-	-	-
Filter Type/ layers	Metallic	Metallic	Metallic	Metallic	Metallic	Metallic	Metallic	Metallic
Anti-grease Filter Number	2	2	2	2	2	2	2	2
Inner Shield	-	-	-	-	√	√	√	√
Glass damped open/closure	-	-	-	-	-	-	-	-
Air purification function	-	-	-	-	-	-	-	-
Air quality sensor	-	-	-	-	-	-	-	-
Anti-drip system	-	-	-	-	-	-	-	-
Lighting								
Light Type	SS Led	SS Led	SS Led	SS Led	Ecoled	Ecoled	Ecoled	Ecoled
Adjustable Intensity Lighting	√	√	√	√	-	-	-	-
Colour temperature	-	-	-	-	-	-	-	-
N° of Lamps	1	1	1	1	2	2	2	2
Installation								
Minimum height distance to a electric worktop hob (mm)	550	550	550	550	550	550	550	550
Minimum height distance to a gas worktop hob (mm)	650	650	650	650	650	650	650	650
Installation with Outlet tube to the exterior / Recirculating	BOTH	BOTH	BOTH	BOTH	BOTH	BOTH	BOTH	BOTH
Easy Installation System	√	√	√	√	√	√	√	√
Electric Connection								
Total Rush Power (W)	93	-	-	-	107	107	107	107
Rated Voltage (V)	220-240	220-240	220-240	220-240	220-240	220-240	220-240	220-240
Network Frequency (Hz)	50	50	50	50	50	50	50	50
Electrical Insulation Class	CLASS I	CLASS I	CLASS I	CLASS I	CLASS I	CLASS I	CLASS I	CLASS I
Plug	-	-	-	-	-	-	-	-
Accessories / ○ NOT INCLUDED ● INCLUDED								
Upper Decorative tube Extension	-	-	-	-	-	-	-	-
White Decorative Tube	-	-	-	-	-	-	-	-
Black Decorative Tube	-	-	-	-	-	-	-	-
Island Tube Enhancer	-	-	-	-	-	-	-	-
Check Valve	02832004 / ○	02832004 / ○	02832004 / ○	02832004 / ○	02849003 / ○	02849003 / ○	02849003 / ○	02849003 / ○
MAX PRO Metal Filter	-	-	-	-	-	-	-	-
Metal Filter	02825279 / ●	02825279 / ●	02825279 / ●	02825279 / ●	02825272* / ●	02825272* / ●	02825273 / ●*	02825274 / ●*
DUAL Filter (metal + active charcoal)	-	-	-	-	-	-	-	-
Active Charcoal Filter	02859394 / ○	02859394 / ○	02859394 / ○	02859394 / ○	02825263 / ○	02825263 / ○	02825263 / ○	02825263 / ○
Noiseless Flexible Duct	02893002 / ○	02893002 / ○	02893002 / ○	02893002 / ○	-	-	-	-
Top outlet motor cover	-	-	-	-	-	-	-	-
FCA kit without duct cover	-	-	-	-	-	-	-	-

02017305	02034310	02034501	02034606	02034107	02034408	02097305	02097306	02034604	02034505	02011603	02011112
8422248061988	8422248082129	8422248082136	8422248101998	8422248102001	8422248108096	8422248086264	8422248102018	8422248357234	8422248357227	8422248371308	8422248371315
TF-2003 DURALUM 600	TF-5260 X	TF-5260 WH	TFB-5160 X	TFB-5160 WH	TFB-5160 BK	TF-5250 X	TFB-5150 X	TFK 6005 X	TFK 6005 WH	LFK 6001 X	LFK 6001 WH
Telescopic	Telescopic	Telescopic	Telescopic	Telescopic	Telescopic	Telescopic	Telescopic	Telescopic	Telescopic	Standard	Standard
44,5	78,3	78,3	27,3	27,3	27,3	78,3	31,1	32,1	32,1	29,6	29,6
C	D	D	B	B	B	D	C	B	B	B	B
11,9	9	9	16	16	16	9	11,7	20,6	20,6	11,5	11,5
E	E	E	D	D	D	E	E	C	C	E	E
36	9,3	9,3	44	44	44	9,3	46	35,6	35,6	15,5	15,5
A	E	E	A	A	A	E	A	A	A	D	D
68	66,5	66,5	67	67	67	66,5	62,6	70	70	67,7	67,7
D	D	D	D	D	D	D	E	D	D	D	D
150	174,8	174,8	175,1	175,1	175,1	174,8	179,6	186	186	108	108
390	325,1	325,1	344,4	344,4	344,4	325,1	319,6	360	360	162	162
-	-	-	-	-	-	-	-	-	-	-	-
45	54	54	51	51	51	54	51	54	54	49	49
57	68	68	64	64	64	68	62	68	68	58	58
-	-	-	-	-	-	-	-	-	-	-	-
0	0	0	0	0	0	0	0	0	0	0	0
0	0	0	-	-	-	0	-	0	0	0	0
1,6	1,7	1,7	1,8	1,8	1,8	1,7	1,6	1,3	1,3	1,6	1,6
78,2	93,5	93,5	61,6	61,6	61,6	93,5	70,2	62,2	62,2	69,2	69,2
198,2	198	198	206,4	206,4	206,4	198	173,7	203,8	203,8	91,5	91,5
148	185	185	142	142	142	185	123	229,1	229,1	211,9	211,9
68,6	113,3	113,3	50,9	50,9	50,9	113,3	50,8	63	63	47	47
7	11	11	1,8	1,8	1,8	11	2	3	3	3	3
252	102	102	79	79	79	102	92	107	107	46,5	46,5
600	600	600	595	595	595	600	495	600	600	600	600
280	280	280	297	297	297	280	297	280	280	452	452
180	175	175	200	200	200	175	200	175	175	85	85
180	175	175	225	225	225	175	225	175	175	85	85
150	150	150	150	150	150	150	150	120	120	120	120
TF 2003	2 x LIN	2 x LIN	TT300	TT300	TT300	2 x LIN	TT300	K11-360	K11-360	L1B	L1B
5+1	5+1	5+1	5+1	5+1	5+1	5+1	5+1	3	3	3	3
100	2 x 65	2 x 65	65	65	65	2 x 65	65	90	90	55	55
194	301	301	170	170	170	301	170	251	251	318	318
-	-	-	-	-	-	-	-	-	-	-	-
Rocker Switch	Slider	Slider	Rocker Switch	Rocker Switch	Rocker Switch	Slider	Rocker Switch	Slider	Slider	Mechanic	Mechanic
-	-	-	-	-	-	-	-	-	-	-	-
-	-	-	-	-	-	-	-	-	-	-	-
-	-	-	-	-	-	-	-	-	-	-	-
-	-	-	-	-	-	-	-	-	-	-	-
Metallic	Metallic	Metallic	Metallic	Metallic	Metallic	Metallic	Metallic	Metallic	Metallic	Acrylic	Acrylic
2	2	2	2	2	2	2	2	2	2	1	1
√	-	-	-	-	-	-	√	-	-	-	-
-	-	-	-	-	-	-	-	-	-	-	-
-	-	-	-	-	-	-	-	-	-	-	-
-	-	-	-	-	-	-	-	-	-	-	-
Ecoled	LED E-14	LED E-14	CSLED	CSLED	CSLED	LED E-14	CSLED	CSLED	CSLED	E14	E14
-	-	-	-	-	-	-	-	-	-	-	-
2	2	2	1	1	1	2	1	1	1	1	1
550	550	550	550	550	550	550	550	550	550	550	550
650	650	650	650	650	650	650	650	650	650	650	650
BOTH	BOTH	BOTH	BOTH	BOTH	BOTH	BOTH	BOTH	BOTH	BOTH	BOTH	BOTH
√	√	√	√	√	√	√	√	√	√	√	√
107	141	141	67	67	67	141	67	93	93	58	58
220-240	220-240	220-240	220-240	220-240	220-240	220-240	220-240	220-240	220-240	220-240	220-240
50	50	50	50 / 60	50 / 60	50 / 60	50	50 / 60	50	50	50	50
CLASS I	CLASS II	CLASS II	CLASS I	CLASS I	CLASS I	CLASS II	CLASS I	CLASS II	CLASS II	CLASS I	CLASS I
-	EU 2 Pins	EU 2 Pins	VDE	VDE	VDE	EU 2 Pins	VDE	-	-	-	-
-	-	-	-	-	-	-	-	-	-	-	-
-	-	-	-	-	-	-	-	-	-	-	-
-	-	-	-	-	-	-	-	-	-	-	-
02849003 / O	02849002 / O	02849002 / O	-	-	-	02849002 / O	-	02849002 / O	02849002 / O	02849002 / O	02849002 / O
02825272 / ●	02825270 / ●	02825270 / ●	02800981 / ●	02800981 / ●	02800981 / ●	02825270 / ●	02800977 / ●	02825270 / ●	02825270 / ●	02833166 / ●	02833166 / ●
-	-	-	-	-	-	-	-	-	-	-	-
02825263 / O	02846762 / O	02846762 / O	02859495 / O	02859495 / O	02859495 / O	02846762 / O	02859495 / O	02859489 / O	02859489 / O	02846764 / O	02846764 / O
-	-	-	-	-	-	-	-	-	-	-	-

Code	02011121	02011602	02011117	02015306	02015006	02014302	02011604	02011504	02011204
EAN	8422248371322	8422248357180	8422248357197	8422248086103	8422248086110	8422248168946	8422248357241	8422248357258	8422248357265
Model	LFK 6001 WH +FCA	LFK 6000 X	LFK 6000 WH	F-2050 X	F-2050 WH	F-2290 X	FK SLIM 6000 X	FK SLIM 6000 BK	FK SLIM 6000 WH
Type	Standard	Standard	Standard	Standard	Standard	Standard	Standard	Standard	Standard
Product fiche according to directives EU65/2014 - EN61591, EN60704-2-13, EN50564									
AEC (Annual Energy consumption) (kWh/annum)	29,6	29,6	29,6	44,7	44,7	-	29,6	29,6	29,6
EEL class (Energy Efficiency Class)	B	B	B	C	C	-	B	B	B
FDE (Fluid Dynamic Efficiency)	11,5	11,5	11,5	9,2	9,2	-	11,5	11,5	11,5
FDE class (Fluid Dynamic Efficiency Class)	E	E	E	E	E	-	E	E	E
LE (Lighting Efficiency) (lux/W)	15,5	15,5	15,5	27,3	27,3	-	15,5	15,5	15,5
LE class (Lighting Efficiency Class)	D	D	D	B	B	-	D	D	D
GFE (Grease Filtering Efficiency)	67,7	67,7	67,7	67,7	67,7	-	67,7	67,7	67,7
GFE Class (Grease Filtering Efficiency class)	D	D	D	D	D	-	D	D	D
Air flow at minimum speed (m³/h)	108	108	108	107,5	107,5	-	108	108	108
Air flow at maximum speed (m³/h)	162	162	162	193,5	193,5	-	162	162	162
Air flow at intensive speed (TURBO) (m³/h)	-	-	-	-	-	-	-	-	-
Sound Power Level at minimum speed (dB)	49	49	49	56	56	-	49	49	49
Sound Power Level at maximum speed (dB)	58	58	58	68	68	-	58	58	58
Sound Power Level at intensive speed (TURBO) (dB)	-	-	-	-	-	-	-	-	-
Po (Power Consumption in off mode) (W)	0	0	0	0	0	-	0	0	0
Ps (Power Consumption in standby) (W)	0	0	0	0	0	-	0	0	0
Integration directive EU 66/2014									
f (Time Increase Factor)	1,6	1,6	1,6	1,7	1,7	-	1,6	1,6	1,6
EEL (Energy Efficiency Index)	69,2	69,2	69,2	82,2	82,2	-	69,2	69,2	69,2
Q _{BEF} (Flow Rate at Best Efficiency Point) (m³/h)	91,5	91,5	91,5	105,2	105,2	-	91,5	91,5	91,5
P _{BEF} (Static Pressure Difference at Best Efficiency Point) (Pa)	211,9	211,9	211,9	209	209	-	211,9	211,9	211,9
W _{BEF} (Electric Power Input at Best Efficiency Point) (W)	47	47	47	201	201	-	47	47	47
W _i (Nominal Power Consumption of Lighting system) (W)	3	3	3	5,5	5,5	-	3	3	3
E _{mean} (Average Illumination of Lighting system on Cooking surface) (lux)	46,5	46,5	46,5	150	150	-	46,5	46,5	46,5
External Dimensions									
Width (mm)	600	600	600	600	600	900	600	600	600
Depth (mm)	452	425	425	470	470	470	470	470	470
Total max height (mm)	85	85	85	112	112	150	112	112	112
Total min height (mm)	85	85	85	112	112	150	112	112	112
Outlet Diameter (mm)	120	120	120	150	150	150	120	120	120
Characteristics									
Motor	L1B	L1B	L1B	L1N	L1N	TF	L1B	L1B	L1B
Extraction Levels	3	2	2	5+1	5+1	5+1	3	3	3
Maximum Power Consumption	55	55	55	60	60	2 x 125	55	55	55
Maximum Pressure	318	318	318	325	325	179	318	318	318
Intensive Speed (TURBO) Pressure	-	-	-	-	-	-	-	-	-
Control Type	Mechanic	Rocker	Rocker	Mechanic	Mechanic	Slider	Mechanic	Mechanic	Mechanic
Connectivity	-	-	-	-	-	-	-	-	-
Automatic removal	-	-	-	-	-	-	-	-	-
Automatic shut-down timer	-	-	-	-	-	-	-	-	-
Electronic Filter Saturation Indicator	-	-	-	-	-	-	-	-	-
Filter Type/ layers	Acrylic	Acrylic	Acrylic	Aluminium Mesh	Aluminium Mesh	Aluminium Mesh	Aluminium Mesh	Aluminium Mesh	Aluminium Mesh
Anti-grease Filter Number	1	1	1	1	1	1	1	1	1
Inner Shield	-	-	-	-	-	-	-	-	-
Glass damped open/closure	-	-	-	-	-	-	-	-	-
Air purification function	-	-	-	-	-	-	-	-	-
Air quality sensor	-	-	-	-	-	-	-	-	-
Anti-drip system	-	-	-	-	-	-	-	-	-
Lighting									
Light Type	E14	E14	E14	LED E-14	LED E-14	Halogen E-14	E14	E14	E14
Adjustable Intensity Lighting	-	-	-	-	-	-	-	-	-
Colour temperature	-	-	-	-	-	-	-	-	-
N° of Lamps	1	1	1	1	1	2	1	1	1
Installation									
Minimum height distance to a electric worktop hob (mm)	550	550	550	550	550	550	550	550	550
Minimum height distance to a gas worktop hob (mm)	650	650	650	650	650	650	650	650	650
Installation with Outlet tube to the exterior / Recirculating	BOTH	BOTH	BOTH	BOTH	BOTH	BOTH	BOTH	BOTH	BOTH
Easy Installation System	√	√	√	√	√	√	√	√	√
Electric Connection									
Total Rush Power (W)	58	58	58	65,5	65,5	306	58	58	58
Rated Voltage (V)	220-240	220-240	220-240	220-240	220-240	220-240	220-240	220-240	220-240
Network Frequency (Hz)	50	50	50	50	50	50	50	50	50
Electrical Insulation Class	CLASS I	CLASS I	CLASS I	CLASS I	CLASS I	CLASS II	CLASS I	CLASS I	CLASS I
Plug	-	-	-	-	-	EU 2 Pins	-	-	-
Accessories / ○ NOT INCLUDED ● INCLUDED									
Upper Decorative tube Extension	-	-	-	-	-	-	-	-	-
White Decorative Tube	-	-	-	-	-	-	-	-	-
Black Decorative Tube	-	-	-	-	-	-	-	-	-
Island Tube Enhancer	-	-	-	-	-	-	-	-	-
Check Valve	02849002 / ○	02849002 / ○	02849002 / ○	02849002 / ○	02849002 / ○	02849002 / ○	02849002 / ○	02849002 / ○	02849002 / ○
MAX PRO Metal Filter	-	-	-	-	-	-	-	-	-
Metal Filter	02833166 / ●	02833166 / ●	02833166 / ●	02833162 / ●	02833162 / ●	02833162 / ●	02833162 / ●	02833162 / ●	02833162 / ●
DUAL Filter (metal + active charcoal)	-	-	-	-	-	-	-	-	-
Active Charcoal Filter	02846764 / ●	02846764 / ○	02846764 / ○	02846764 / ○	02846764 / ○	02846764 / ○	02859389 / ○	02859389 / ○	02859389 / ○
Noiseless Flexible Duct	-	-	-	-	-	-	-	-	-
Top outlet motor cover	-	-	-	-	-	-	-	-	-
FCA kit without duct cover	-	-	-	-	-	-	-	-	-

Code	00117000	00117100	00117400	00116110	00116002	00116400	00114102	00111002
EAN	8422248100816	8422248100823	8422248010832	8422248006316	8422248100601	8422248357371	8422248100403	8422248100830
Model	PROFESSIONAL 750	PROFESSIONAL 750 L	PROFESSIONAL 500	600 PLUS 2V	GS 600	GS 600 BK	GS 400 M	GS 400 P
Type	Kitchen Extractor	Kitchen Extractor	Kitchen Extractor	Kitchen Extractor	Kitchen Extractor	Kitchen Extractor	Kitchen Extractor	Kitchen Extractor
Product fiche according to directives EU65/2014 - EN61591, EN60704-2-13, EN50564								
AEC (Annual Energy consumption) (kWh/annum)	54,8	65,1	69,3	54,8	51,7	51,7	29,2	30,3
EEL class (Energy Efficiency Class)	C	D	D	C	C	C	B	B
FDE (Fluid Dynamic Efficiency)	9,2	9,2	5,1	9,3	12,5	12,5	10,7	10,5
FDE class (Fluid Dynamic Efficiency Class)	E	E	F	E	E	E	E	E
LE (Lighting Efficiency) (lux/W)	-	8,1	-	-	-	-	-	-
LE class (Lighting Efficiency Class)	-	E	-	-	-	-	-	-
GFE (Grease Filtering Efficiency)	53,7	53,7	51,9	51,9	-	-	-	-
GFE Class (Grease Filtering Efficiency class)	F	F	F	F	-	-	-	-
Air flow at minimum speed (m³/h)	-	-	-	420	-	-	-	-
Air flow at maximum speed (m³/h)	600	600	450	600	480	480	290	290
Air flow at intensive speed (TURBO) (m³/h)	-	-	-	-	-	-	-	-
Sound Power Level at minimum speed (dB)	-	-	-	45	-	-	-	-
Sound Power Level at maximum speed (dB)	49	49	57	52	50	50	52	52
Sound Power Level at intensive speed (TURBO) (dB)	-	-	-	-	-	-	-	-
Po (Power Consumption in off mode) (W)	0	0	0	0	0	0	0	0
Ps (Power Consumption in standby) (W)	0	0	0	0	0	0	0	0
Integration directive EU 66/2014								
f (Time Increase Factor)	1,7	1,7	1,8	1,7	1,6	1,6	1,6	1,6
EEL (Energy Efficiency Index)	84,6	84,6	95,2	84,5	78,9	78,9	68,7	69,7
Q _{best} (Flow Rate at Best Efficiency Point) (m³/h)	284,5	284,5	134,6	285,9	311,7	311,7	163,2	174,2
P _{best} (Static Pressure Difference at Best Efficiency Point) (Pa)	105	105	142	105	131,6	131,6	117	110,6
W _{best} (Electric Power Input at Best Efficiency Point) (W)	90,1	90,1	104,6	90,1	91,4	91,4	49,6	51,1
W _t (Nominal Power Consumption of Lighting system) (W)	-	14	-	-	-	-	-	-
E _{MODULE} (Average Illumination of Lighting system on Cooking surface) (lux)	-	113	-	-	-	-	-	-
External Dimensions								
Width (mm)	356	356	260	355	375	375	250	240
Depth (mm)	235	235	173	134	136	136	125	120
Total max height (mm)	-	-	-	-	-	-	-	-
Total min height (mm)	650	650	650	650	650	650	650	650
Outlet Diameter (mm)	150	120	100	120	125	125	110	110
Characteristics								
Motor	Inducción	Inducción	Inducción	Inducción	Inducción	Inducción	Inducción	Inducción
Extraction Levels	1	1	1	2	1	1	1	1
Maximum Power Consumption	105W	105W	125W	105W	105W	105W	60W	60W
Maximum Pressure	190	190	235	205	200	200	210	225
Intensive Speed (TURBO) Pressure	-	-	-	-	-	-	-	-
Control Type	-	-	-	Commutador	-	-	-	-
Connectivity	-	-	-	-	-	-	-	-
Automatic removal	-	-	-	-	-	-	-	-
Automatic shut-down timer	-	-	-	-	-	-	-	-
Electronic Filter Saturation Indicator	-	-	-	-	-	-	-	-
Filter Type/ layers	Metálico	Metálico	Metálico	Metálico	-	-	-	-
Anti-grease Filter Number	1	1	1	1	-	-	-	-
Inner Shield	-	-	-	-	-	-	-	-
Glass damped open/closure	-	-	-	-	-	-	-	-
Air purification function	-	-	-	-	-	-	-	-
Air quality sensor	-	-	-	-	-	-	-	-
Anti-drip system	-	-	-	-	-	-	-	-
Lighting								
Light Type	-	E-14 x 28W	-	-	-	-	-	-
Adjustable Intensity Lighting	-	-	-	-	-	-	-	-
Colour temperature	-	-	-	-	-	-	-	-
Nº of Lamps	-	2	-	-	-	-	-	-
Installation								
Minimum height distance to a electric worktop hob (mm)	65	65	65	65	65	65	65	65
Minimum height distance to a gas worktop hob (mm)	65	65	65	65	65	65	65	65
Installation with Outlet tube to the exterior / Recirculating	EXTERIOR	EXTERIOR	EXTERIOR	EXTERIOR	EXTERIOR	EXTERIOR	EXTERIOR	EXTERIOR
Easy Installation System	√	√	√	√	√	√	√	√
Electric Connection								
Total Rush Power (W)	105	161	125	105	105	105	60	60
Rated Voltage (V)	230	230	230	230	230	230	230	230
Network Frequency (Hz)	50	50	50	50	50	50	50	50
Electrical Insulation Class	CLASE I	CLASE I	CLASE II	CLASE I	CLASE I	CLASE I	CLASE I	CLASE I
Plug	-	-	-	-	-	-	-	-
Accessories / ○ NOT INCLUDED ● INCLUDED								
Upper Decorative tube Extension	-	-	-	-	-	-	-	-
White Decorative Tube	-	-	-	-	-	-	-	-
Black Decorative Tube	-	-	-	-	-	-	-	-
Island Tube Enhancer	-	-	-	-	-	-	-	-
Check Valve	-	-	-	-	-	-	-	-
MAX PRO Metal Filter	-	-	-	-	-	-	-	-
Metal Filter	01140700* ●	01140700* ●	01140801* ●	01100000* ●	-	-	-	-
DUAL Filter (metal + active charcoal)	-	-	01140800 / O	-	-	-	-	-
Active Charcoal Filter	-	-	-	-	-	-	-	-
Noiseless Flexible Duct	-	-	-	-	-	-	-	-
Top outlet motor cover	-	-	-	-	-	-	-	-
FCA kit without duct cover	-	-	-	-	-	-	-	-

Code	07002411	07002412	07001006	07033303	07007303	07044600	07001509
EAN	8422248094009	8422248094016	8422248103350	8422248076029	8422248075886	8422248075831	8422248347846
Model	MT 8012 BK	MT 8012 WH	PR 6011 XGBK	MD6106X	ME6206X	SE6204X	MDS 8008 X AIR FRYER
Type	Multifunction Turbo	Multifunction Turbo	Multifunction PYRO	Multifunción	Multifunción	Static	Multifunction Turbo
Product fiche according to EU 65/2014 y EU 66/2014							
Energy efficiency index (IEE)	86,6	86,6	94	117,1 / 106,6	102	117,1	117
Energy efficiency Class	A	A	A	A	A	A	A
Energy consumption in conventional mode [kWh/cycle]	0,71	0,71	0,99	0,82	0,81	0,79	0,85
Energy consumption in fan-forced mode [kWh/cycle]	0,81	0,81	0,79	0,79	0,89	-	0,84
Number of cavities	1	1	1	1	1	1	1
Heat source	Electricity	Electricity	Electricity	Electricity	Electricity	Electricity	Electricity
Mass of the appliance [Kg]	39,5	39,5	39	28	28	28	30,9
Cavity volume (L)	72	72	70	60	60	65	80
Dimensions							
Width [mm]	595	595	595	595	595	595	595
Height [mm]	595	595	595	595	595	595	595
Depth [mm]	568	568	575	507	507	507	543
Cavity width [mm]	346,5	346,5	487	450	450	450	477
Cavity height [mm]	457	457	350	330	330	330	394
Cavity depth [mm]	410	410	420	440	410	440	425
Characteristics							
Finishing	Black glass	White glass	Stainless steel and black glass	Stainless steel and black glass	Stainless steel and black glass	Stainless steel and black glass	Stainless steel and Black glass
Soft Door closing	Yes	Yes	No	No	No	No	No
Tray levels	5	5	5	5	5	5	6
Convection Fan	Yes	Yes	Yes	Yes	Yes	No	Yes
Number of light bulbs	1	1	1	1	1	1	1
Controls							
Oven control	Electronic	Electronic	Electronic	Electronic	Mechanic	Mechanic	Electronic - Mechanic
Control type	Touch control	Touch control	Touch with push-pull knobs	Touch control	Knobs	Knobs	Touch with push-pull knobs
Screen Technology	LCD	LCD	White LCD	-	-	-	LED
Cooking programmer start/stop	Yes	Yes	Yes	Yes	-	-	-
Cooking programmer stop	-	-	Yes	Yes	Yes	Yes	-
Minute minder	-	-	-	-	-	-	Yes
Working pilot light	Yes	Yes	-	No	No	No	Yes
Thermostat pilot light	Yes	Yes	Yes	Yes	Yes	Yes	Yes
Min. temperature [°C]	50	50	50	50	50	50	40
Max. Temperature [°C]	250	250	250	250	250	250	240
Cleaning							
Enamel	Non-stick black	Non-stick black	black pyrolytic	Non-stick black	Non-stick black	Non-stick black	Non-stick black
Cavity type	Flat	Flat	Flat	Embossed	Flat	Embossed	Flat
Inner glass	Removable	Removable	Removable	Removable	Removable	Removable	Removable
Pyrolytic Cleaning/levels	-	-	Yes	-	-	-	No
AquaSmart Cleaning	Automatic	Automatic	Manual	Manual	Manual	Manual	Yes
Functions							
Functions	12	12	11	6	7	4	8
Rapid heating	Yes	Yes	No	No	No	No	No
Inner light	Yes	Yes	Yes	Yes	Yes	Yes	Yes
Safety							
Safety lock	Yes	Yes	Yes	No	No	No	Yes
Number of door glasses	3	3	4	2	2	2	2
Cooling fan	Yes	Yes	Yes	Yes	Yes	No	Yes
Security Thermostat	Yes	Yes	Yes	Yes	Yes	Yes	Yes
Electrical connection							
Grill power [W]	2250	2250	2000	2250	2250	1600	1000+2000
Bottom heating element power [W]	1100	1100	1100	1100	1100	900	900
Back heating element power [W]	2000	2000	2000	-	-	-	2300
Total rated Power [W]	2380	2380	3200	2180	2180	2180	2300
Nominal voltage [V] / Mains frequency [Hz]	230-240 / 50-60	230-240 / 50-60	220-240 / 50/60	220-240 / 50/60	220-240 / 50/60	220-240 / 50/60	220-240 / 50/60
Light power [W]	25	25	25	15	15	15	15
Power cord length [m]	1	1	1	1,4	1,4	1,4	1,5
Plug	No	No	Yes	No	No	No	No
Accessories							
Air fry tray	-	-	-	-	-	-	1
Side racks	1	1	1	1	1	-	1
Grill	1	1	1	1	1	1	1
Shallow tray	1	1	1	-	-	-	1
Deep tray	1	1	-	1	1	1	1
Sliding rails	1	1	1	-	-	-	PSC-50%
Turnspit	-	-	-	-	-	-	-
Pizza Stone (optional)	Yes	Yes	-	No	No	No	No

07001010	07001405	07001508	07034101	07034508	07034605	07034606	07044609	07044350	07044105
8422248347679	8422248347655	8422248347662	8422248347709	8422248347693	8422248347686	8422248373173	8422248347716	8422248347297	8422248347730
MDS 8008 WH	MDS 8008 BK	MDS 8008 X	MDS 8007 WH	MDS 8007 BK	MDS 8007 X	MDS 8007 FB	MES 8007 X	SES 7104 X /C	SES 6204 WH
Multifunction Turbo	Multifunction Turbo	Multifunction Turbo	Multifunción	Multifunción	Multifunción	Multifunción	Multifunción	Static	Static
117	117	117	94,4	94,4	94,4	94,4	86,6	95,2	95,2
A	A	A	A	A	A	A	A	A	A
0,85	0,85	0,85	0,85	0,85	0,85	0,85	0,85	0,78	0,79
0,84	0,84	0,84	0,84	0,84	0,84	0,84	0,84	-	-
1	1	1	1	1	1	1	1	1	1
Electricity	Electricity	Electricity	Electricity	Electricity	Electricity	Electricity	Electricity	Electricity	Electricity
30,8	30,4	30,9	28,8	28,8	28,8	28,8	29,4	29	26,6
80	80	80	80	80	80	80	80	78	66
595	595	595	595	595	595	595	595	595	595
595	595	595	595	595	595	595	595	595	595
543	543	543	543	543	543	543	543	547	543
477	477	477	477	477	477	477	477	450	440
394	394	394	394	394	394	394	394	330	316
425	425	425	425	425	425	425	425	480	444
White glass	Black glass	Stainles steal and Black glass	White glass	Black glass	Stainles steal and Black glass	Black glass	Stainles steal and Black glass	Stainles steal and Black glass	White glass
No	No	No	No	No	No	No	No	No	No
6	6	6	6	6	6	6	6	5	4
Yes	Yes	Yes	Yes	Yes	Yes	Yes	Yes	No	No
1	1	1	1	1	1	1	1	1	1
Electronic - Mechanic	Electronic - Mechanic	Electronic - Mechanic	Electronic - Mechanic	Electronic - Mechanic	Electronic - Mechanic	Electronic - Mechanic	Mechanic	Mechanic	Mechanic
Touch with push-pull knobs	Touch with push-pull knobs	Touch with push-pull knobs	Knobs	Knobs	Knobs	Knobs	Knobs	Knobs	Knobs
LED	LED	LED	LED	LED	LED	LED	-	-	-
-	-	-	-	-	-	-	-	-	-
-	-	-	-	-	-	-	-	-	-
Yes	Yes	Yes	Yes	Yes	Yes	Yes	Yes	Yes	Yes
Yes	Yes	Yes	Yes	Yes	Yes	Yes	Yes	Yes	Yes
Yes	Yes	Yes	Yes	Yes	Yes	Yes	Yes	Yes	Yes
40	40	40	40	40	40	40	40	50	40
240	240	240	240	240	240	240	240	250	240
Non-stick black	Non-stick black	Non-stick black	Non-stick black	Non-stick black	Non-stick black	Non-stick black	Non-stick black	Non-stick black	Non-stick black
Flat	Flat	Flat	Flat	Flat	Flat	Flat	Flat	Embossed	Embossed
Removable	Removable	Removable	Removable	Removable	Removable	Removable	Removable	Removable	Removable
No	No	No	No	No	No	No	No	No	No
Yes	Yes	Yes	No	No	No	No	No	Yes	Yes
8	8	8	7	7	7	7	7	4	4
No	No	No	No	No	No	No	No	No	No
Yes	Yes	Yes	Yes	Yes	Yes	Yes	Yes	Yes	Yes
Yes	Yes	Yes	No	No	No	No	No	No	No
2	2	2	2	2	2	2	2	2	2
Yes	Yes	Yes	Yes	Yes	Yes	Yes	Yes	Yes	Yes
Yes	Yes	Yes	Yes	Yes	Yes	Yes	Yes	Yes	Yes
1000+2000	1000+2000	1000+2000	2400	2400	2400	2400	1000+2000	1000+2000	1000+2000
900	900	900	1200	1200	1200	1200	-	1200	1200
2300	2300	2300	1800	1800	1800	1800	2300	-	-
2300	2300	2300	2300	2300	2300	2300	2300	2300	2300
220-240 / 50/60	220-240 / 50/60	220-240 / 50/60	220-240 / 50/60	220-240 / 50/60	220-240 / 50/60	220-240 / 50/60	220-240 / 50/60	220-240 / 50/60	220-240 / 50/60
15	15	15	15	15	15	15	15	15	15
1,5	1,5	1,5	1,5	1,5	1,5	1,5	1,5	0,9	1,5
No	No	No	No	No	No	No	No	No	No
-	-	-	-	-	-	-	-	-	-
1	1	1	1	1	1	1	1	1	-
1	1	1	1	1	1	1	1	1	1
1	1	1	1	1	1	1	1	-	-
1	1	1	1	1	1	1	1	1	1
PSC-50%	PSC-50%	PSC-50%	PSC-50%	PSC-50%	PSC-50%	PSC-50%	PSC-50%	-	-
-	-	-	-	-	-	-	-	-	-
No	No	No	No	No	No	No	No	No	No

Code	07044614	07044613	07044351	07035409	07035009	07003307	07003000
EAN	8422248347839	8422248347754	8422248347235	8422248077026	8422248077033	8422248067881	8422248067898
Model	SES 6004 BK	SES 6004 WH	SES 7004 X / C	MRA7108BK	MRA7108WH	CMD5008X	MD 5008 WH
Type	Static	Static	Static	Multifunción	Multifunción	Multifunction Turbo	Multifunction Turbo
Product fiche according to EU 65/2014 y EU 66/2014							
Energy efficiency index (IEE)	95,2	95,2	95,2	93,8	93,8	97,2	97,2
Energy efficiency Class	A	A	A	A	A	A	A
Energy consumption in conventional mode [kWh/cycle]	0,77	0,77	0,76	0,76	0,76	0,7	0,7
Energy consumption in fan-forced mode [kWh/cycle]	-	-	-	0,75	0,75	0,71	0,71
Number of cavities	1	1	1	1	1	1	1
Heat source	Electricity	Electricity	Electricity	Electricity	Electricity	Electricity	Electricity
Mass of the appliance [Kg]	24,1	24,1	25	28	28	30,4	30,4
Cavity volume (L)	62	62	65	60	60	40	40
Dimensions							
Width [mm]	595	595	595	595	595	595	595
Height [mm]	595	595	595	595	595	456	456
Depth [mm]	543	543	507	565	565	531	531
Cavity width [mm]	440	440	450	472	472	260	260
Cavity height [mm]	316	316	330	316	316	380	380
Cavity depth [mm]	444	444	440	400	400	400	400
Characteristics							
Finishing	Black glass	White glass	Stainless steel and Black glass	Black glass	White glass	Stainless steel	White glass
Soft Door closing	No	No	No	No	No	No	No
Tray levels	4	4	5	5	5	4	4
Convection Fan	No	No	No	Yes	Yes	Yes	Yes
Number of light bulbs	1	1	1	1	1	1	1
Controls							
Oven control	Mechanic	Mechanic	Mechanic	Mechanic	Mechanic	Electronic	Electronic
Control type	Knobs	Knobs	Knobs	Knobs	Knobs	Touch with push-pull knobs	Touch with push-pull knobs
Screen Technology	-	-	-	-	-	LCD	LCD
Cooking programmer start/stop	-	-	-	-	-	Yes	Yes
Cooking programmer stop	-	-	-	-	-	-	-
Minute minder	No	No	No	Yes	Yes	-	-
Working pilot light	Yes	Yes	Yes	No	No	Yes	Yes
Thermostat pilot light	Yes	Yes	Yes	Yes	Yes	Yes	Yes
Min. temperature [°C]	40	40	50	40	40	50	50
Max. temperature [°C]	240	240	250	240	240	250	250
Cleaning							
Enamel	Non-stick black	Non-stick black	Non-stick black	Non-stick black	Non-stick black	Non-stick black	Non-stick black
Cavity type	Embossed	Embossed	Embossed	Flat	Flat	Flat	Flat
Inner glass	Removable	Removable	Removable	Removable	Removable	Fixed	Fixed
Pyrolytic Cleaning/levels	No	No	No	-	-	-	-
AquaSmart Cleaning	Yes	Yes	Yes	No	No	Manual	Manual
Functions							
Functions	4	4	4	7	7	8	8
Rapid heating	No	No	No	No	No	No	No
Inner light	Yes	Yes	Yes	No	No	Yes	Yes
Safety							
Safety lock	No	No	No	No	No	No	No
Number of door glasses	2	2	2	2	2	3	3
Cooling fan	Yes	Yes	Yes	Yes	Yes	Yes	Yes
Security Thermostat	Yes	Yes	Yes	Yes	Yes	Yes	Yes
Electrical connection							
Grill power [W]	1000+2000	1000+2000	1000+2000	1000 + 2000	1000 + 2000	2200	2200
Bottom heating element power [W]	1200	1200	1200	1200	1200	1300	1300
Back heating element power [W]	-	-	-	-	-	2300	2300
Total rated Power [W]	2300	2300	2300	2300	2300	2380	2380
Nominal voltage [V] / Mains frequency [Hz]	220-240 / 50/60	220-240 / 50/60	220-240 / 50/60	220-240 / 50/60	220-240 / 50/60	220-240 / 50/60	220-240 / 50/60
Light power [W]	15	15	15	15	15	25	25
Power cord length [m]	1,5	1,5	0,9	1,25	1,25	1	1
Plug	No	No	No	Yes	Yes	No	No
Accessories							
Air fry tray	-	-	-	-	-	-	-
Side racks	-	-	-	1	1	1	1
Grill	-	-	-	1	1	1	1
Shallow tray	1	1	1	1	1	-	-
Deep tray	-	-	-	1	1	1	1
Sliding rails	-	-	-	-	-	1	1
Turnspit	-	-	-	-	-	-	-
Pizza Stone (optional)	No	No	No	-	-	-	-

07003001	07003002	07003003	07003004	07003305	07039305	07001401	07032307	07032002
8422248372879	8422248372886	8422248372893	8422248372909	8422248067867	8422248093156	8422248059503	8422248059497	8422248058568
MD 5008 BK	CMD 5007 X	MD 5007 BK	MD 5007 WH	ME4006X	CMD 9208 BK	CDP 780 AS BK	CM 760 AS BK	CM 760 AS WH
Multifunction Turbo	Multifunción	Multifunción	Multifunción	Multifunción	Multifunction Turbo	Multifunction Turbo	Multifunción	Multifunción
97,2	97,2	97,2	97,2	97,2	94	117,1	117,1	117,1
A	A	A	A	A	A	A	A	A
0,7	0,7	0,7	0,7	0,7	1,15	0,89	0,89	0,89
0,71	0,71	0,71	0,71	0,71	0,9	0,81	0,81	0,81
1	1	1	1	1	1	1	1	1
Electricity	Electricity	Electricity	Electricity	Electricity	Electricity	Electricity	Electricity	Electricity
30,4	31	31	31	30,4	47,4	36	35	35
40	40	40	40	40	93	50	50	50
595	595	595	595	595	895	595	595	595
456	456	456	456	456	480	595	595	595
531	531	531	531	531	546	480	480	480
260	260	260	260	260	658	410	410	410
380	380	380	380	380	345	325	325	325
400	400	400	400	400	410	375	375	375
Black glass	Stainless steel	Black glass	White glass	Stainless steel	Black glass	Stainless steel and black glass	Stainless steel and black glass	Stainless steel and white glass
No	No	No	No	No	No	No	No	No
4	4	4	4	4	5	5	5	5
Yes	Yes	Yes	Yes	Yes	Yes	Yes	Yes	Yes
1	1	1	1	1	2	1	1	1
Electronic	Electronic	Electronic	Electronic	Mechanic	Electronic	Electronic	Mechanic	Mechanic
Touch with push-pull knobs	Touch with push-pull knobs	Touch with push-pull knobs	Touch with push-pull knobs	Knobs	Touch with push-pull knobs	Touch with push-pull knobs	Knobs	Knobs
LCD	LCD	LCD	LCD	-	LCD	LCD	-	-
Yes	Yes	Yes	Yes	-	No	Yes	No	No
-	-	-	-	-	Yes	-	No	No
-	-	-	-	No	No	-	Yes	Yes
Yes	Yes	Yes	Yes	Yes	Yes	Yes	Yes	Yes
Yes	Yes	Yes	Yes	Yes	Yes	Yes	Yes	Yes
50	50	50	50	50	50	50	50	50
250	250	250	250	250	250	250	250	250
Non-stick black	Non-stick black	Non-stick black	Non-stick black	Non-stick black	Non-stick black	Non-stick black	Non-stick black	Non-stick black
Flat	Flat	Flat	Flat	Embossed	Flat	Flat	Embossed	Embossed
Fixed	Fixed	Fixed	Fixed	Fixed	Removable	Removable	Removable	Removable
-	-	-	-	-	-	-	-	-
Manual	Manual	Manual	Manual	Manual	Ñao	Manual	Manual	Ñao
8	6	6	6	6	10	6	6	6
No	No	No	No	No	No	No	No	No
Yes	Yes	Yes	Yes	Yes	Yes	Yes	Yes	Yes
No	No	No	No	No	Yes	No	No	No
3	3	3	3	3	3	2	2	2
Yes	Yes	Yes	Yes	Yes	Yes	Yes	Yes	Yes
Yes	Yes	Yes	Yes	Yes	Yes	Yes	Yes	Yes
2200	900+1350	900+1350	900+1350	2200	900 + 1800	2350	2350	2350
1300	1300	1300	1300	1300	1500	1300	1300	1300
2300				-	2500	2300	-	-
2380	2380	2380	2380	2380	2800	2450	2450	2450
220-240 / 50/60	220-240 / 50/60	220-240 / 50/60	220-240 / 50/60	220-240 / 50/60	220-240 / 50/60	220-240 / 50/60	220-240 / 50/60	220-240 / 50/60
25	25	25	25	25	2 x 25	2 x 25	25	25
1	1	1	1	1	1,0	1,0	1	1
No	No	No	No	No	No	No	No	No
-	-	-	-	-	-	-	-	-
1	1	1	1	-	1	1	-	-
1	1	1	1	1	1	1	1	1
-	-	-	-	1	-	1	-	-
1	1	1	1	-	1	1	1	1
1	1	1	1	-	-	1	-	-
-	-	-	-	-	-	-	-	-
-	-	-	-	-	-	-	-	-

Code	07510400	07510000	07510303	07510300	07511402	07511306	07510003
EAN	8422248055277	8422248055260	8422248055253	8422248048453	8422248100151	8422248108119	8422248077187
Model	MC 25 GTC BK	MC 25 GTC WH	MC 32 DC	MC 25 D ENC	MW B12505DCG BK	MW B12505DCG X	MMA 20 WH
Type (Built in / free standing)	Built in	Built in	Built in	Built in	Built in	Built in	Built in
DIMENSIONS							
Appliance width [mm]	595	595	595	595	592	592	595
Appliance height [mm]	388	388	388	388	390	390	382
Appliance depth [mm]	400	400	468	400	400	382	344
Cavity width [mm]	328	328	351	328	330	348	295
Cavity height [mm]	208	208	249	208	212	213	218
Cavity depth [mm]	369	369	358	369	330	334	314
Characteristics							
Finishing	Black glass	White glass	Stainless steel	Stainless steel	Black glass	Stainless steel	White glass
Door opening System	Push button	Push button	Push button	Push button	Push button	Push button	Push button
Cavity capacity [L]	25	25	32	25	25	25	20
Cavity construction type	Stainless steel	Stainless steel	Stainless steel	Stainless steel	Stainless steel	Stainless steel	Stainless steel
Inside light	Yes	Yes	Yes	Yes	Yes	Yes	Yes
Opening door angle [degrees]	90	90	90	90	88	90	90
Noise level db[A]	63	63	63	63	68	68	63
Microwave ovens without turntable							
Controls							
Control type	Electronic	Electronic	Electronic	Electronic	Electronic	Electronic	Mechanic
Display technology	LCD	LCD	LCD	LCD	LCD	LCD	-
Display Color	Red	Red	White	White	White	White	-
Electronic timer	Yes	Yes	Yes	Yes	Yes	Yes	No
Manual timer	No	No	No	No	No	No	Yes
Start/Stop button	Yes	Yes	Yes	Yes	Yes	Yes	No
Timer [min]	95	95	95	95	60	60	35
Power selector	Yes	Yes	Yes	Yes	Yes	Yes	Yes
Function selector	Yes	Yes	Yes	Yes	Yes	Yes	No
Temperature selector	Yes	Yes	Yes	Yes	Yes	Yes	No
Working indicator	LED display	LED display	LED display	LED display	LED display	LED display	No
Weight selector	Yes	Yes	Yes	Yes	Yes	Yes	No
Programs							
Number of programmes	8	8	10	8	9	9	9
N° of microwaves programs	5	5	5	5	5	5	5
N° of grill cooking programs	1	1	1	1	2	2	1
N° of grill+mw/ mw+turbo / grill+mw+turbo/grill+turbo cooking programs	2/-/-/-	2/-/-/-	1/1/1/1	2/-/-/-	2/-/-/-	2/-/-/-	3/-/-/-
Auto cook	Vegetables, Fish, Meat, Pasta, Potatoes, Broth, Pizza, Pop corn	Vegetables, Fish, Meat, Pasta, Potatoes, Broth, Pizza, Pop corn	Vegetables, Fish, Meat, Pasta, Potatoes, Broth, Chicken, Toast, Cake, Pizza	Vegetables, Fish, Meat, Pasta, Potatoes, Broth, Chicken, Pizza, Reheat	Milk/Soup/Vegetables/Meat/Meat/Pasta/Fish/Bread/Chicken	6/ Rice/Vegetable/Meat/Noodle/Fish/Bread	
Grill	Yes	Yes	Yes	Yes	Yes	Yes	Yes
Simultaneous grill + microwave	Yes	Yes	Yes	Yes	Yes	Yes	Yes
Convection fan	No	No	Yes	No	No	No	No
Defrosting, heating and cooking by food type	Yes	Yes	Yes	Yes	Yes	Yes	Yes
Memories	No	No	No	No	No	Yes	No
Quick start	Yes	Yes	Yes	Yes	Yes	Yes	No
Cleaning system	No	No	No	No	No	No	No
Safety							
Safety thermostat	Yes	Yes	Yes	Yes	Yes	Yes	Yes
Safety automatic disconnection	No	No	No	No	No	No	No
Child safety lock	Yes	Yes	Yes	Yes	Yes	Yes	No
Door temperature	65	65	65	65	65	65	65
N° of glasses in the door	1	1	1	1	1	1	1
Electrical connection							
Grill power [W]	1000	1000	1100	1000	1200	1200	1000
Microwave power [W]	900	900	1000	900	900	900	800
Convection power [W]	-	-	2500	-	-	-	-
Rated power [W]	1450	1450	1550	1450	1280	1400	1250
Voltage [V]	230	230	230-240	230	220 - 240	230	230
Frecuency [Hz]	50	50	50	50	50	50	50
Power cord length	1000	1000	1000	1000	1100	1100	1000
Plug type	Schuko	Schuko	Schuko	Schuko	Schuko	Schuko	Schuko
Accessories							
Rotatory removable glass	Yes	Yes	Yes	Yes	Yes	Yes	Yes
Diameter of glass dish [mm]	315	315	315	315	315	315	245
Grill rack							
Built in frame						Included	Included
Wall unit installation	No	No	No	No	No	No	Yes
Ventilation kit	No	No	No	No	No	No	No

07510308	07510301	07510312	07510313	07510306
8422248077170	8422248049450	8422248373128	8422248373135	8422248058476
MMA 20 X	MC 20 D ENC	MC 20 D BK	MC 20 M BK	MC 20 IX
Built in	Built in	Built in	Built in	Built in
595	595	595	595	595
382	388	390	390	388
344	348	313	313	328
295	295	315	315	295
218	218	180	180	218
314	314	295	295	314
Stainless steel	Stainless steel	Black glass	Black glass	Stainless steel
Push button	Push button	Push button	Push button	Push button
20	20	20	20	20
Stainless steel	Stainless steel	Stainless steel	Stainless steel	Stainless steel
Yes	Yes	Yes	Yes	Yes
90	90	88	88	90
63	63	68	68	63
Mechanic	Electronic	Mechanic	Electronic	Mechanic
-	LCD	LCD	-	-
-	Red	White	-	-
No	Yes	Yes	No	No
Yes	No	No	Yes	Yes
No	Yes	Yes	No	No
35	95	60	30	35
Yes	Yes	Yes	Yes	Yes
No	Yes	Yes	No	No
No	Yes	Yes	No	No
No	LED display	LED display	LED display	No
No	Yes	Yes	Yes	No
9	8	9	9	9
5	5	5	5	5
1	1	2	1	1
3/-/-/-	2/-/-/-	2/-/-/-	3/-/-/-	3/-/-/-
	Vegetables, Fish, Meat, Pasta, Potatoes, Broth, Pizza, Pop corn	Rice/Vegetable/Meat/Noodle/Fish/Reheat	-	
Yes	Yes	Yes	Yes	Yes
Yes	Yes	Yes	Yes	Yes
No	No	No	No	No
Yes	Yes	Yes	Yes	Yes
No	No	No	No	No
No	Yes	Yes	No	No
No	No	No	No	No
Yes	Yes	Yes	Yes	Yes
No	No	No	No	No
No	No	Yes	No	No
65	65	65	65	65
1	1	1	1	1
1000	1000	800	800	1000
800	800	700	700	800
-	-	-	-	-
1250	1250	1080	1080	1250
230	230 - 240	220 - 240	220 - 240	230
50	50	50	50	50
1000	1000	1100	1100	1000
Schuko	Schuko	Schuko	Schuko	Schuko
Yes	Yes	Yes	Yes	Yes
245	245	245	245	245
		Yes	Yes	
Included	Included	Included	Included	Included
Yes	Yes	Yes	Yes	Yes
No	No	No	No	No

Code	08026001	08026002	08026003	08026609	08000200	08000405	08000206	08000406
EAN	8422248054485	8422248059190	8422248059206	8422248069014	8422248358699	8422248109406	8422248358705	8422248198554
Model	GIGA 750 BK	GIGA 600 BK	GIGA 600 WH	GIGA 600 SD	IAS 7024	AS 750	IAS 6024	AS 600
Type	Induction	Induction	Induction	Induction	Surface	Surface	Surface	Surface
Product fiche								
Cooking zones	6	4	4	4	4	4	4	4
Right front zone: Diameter (mm)	237x189	237x189	237x189	237x189	210x190	190x190	210x190	190x190
Right front zone: Power (kW)	2,1	2,1	2,1	2,1	2,2	2	2,2	2
Right front zone: Booster (kW)	3,7	3,7	3,7	3,7	3	2,8	3	2,8
Right front zone: Consumption (Wh/kg)	182,7	182,7	182,7	182,7	191,8	206,8	190,8	206,8
Right rear zone: Diameter (mm)	237x189	237x189	237x189	237x189	210x190	190x190	210x190	190x190
Right rear zone: Power (kW)	2,1	2,1	2,1	2,1	2,2	1,5	2,2	1,5
Right rear zone: Booster (kW)	3,7	3,7	3,7	3,7	2,6	2	2,6	2
Right rear zone: Consumption (Wh/kg)	182,7	182,7	182,7	182,7	190,8	181,5	190,8	181,5
Central front zone: Diameter (mm)	237x189	-	-	-	-	-	-	-
Central front zone: Power (kW)	2,1	-	-	-	-	-	-	-
Central front zone: Booster (kW)	3,7	-	-	-	-	-	-	-
Central front zone: Consumption (Wh/kg)	182,7	-	-	-	-	-	-	-
Central rear zone: Diameter (mm)	237x189	-	-	-	-	-	-	-
Central rear zone: Power (kW)	2,1	-	-	-	-	-	-	-
Central rear zone: Booster (kW)	3,7	-	-	-	-	-	-	-
Central rear zone: Consumption (Wh/kg)	182,7	-	-	-	-	-	-	-
Front left zone: Diameter (mm)	237x189	237x189	237x189	237x189	210x190	190x190	210x190	190x190
Front left zone: Power (kW)	2,1	2,1	2,1	2,1	2,2	2	2,2	2
Front left zone: Booster (kW)	3,7	3,7	3,7	3,7	3	2,8	3	2,8
Front left zone: Consumption (Wh/kg)	182,7	182,7	182,7	182,7	190,8	194,2	190,8	194,2
Left rear zone: Diameter (mm)	237x189	237x189	237x189	237x189	210x190	190x190	210x190	190x190
Left rear zone: Power (kW)	2,1	2,1	2,1	2,1	2,2	1,5	2,2	1,5
Left rear zone: Booster (kW)	3,7	3,7	3,7	3,7	2,6	2	2,6	2
Left rear zone: Consumption (Wh/kg)	182,7	182,7	182,7	182,7	190,8	181,5	190,8	181,5
Energy consumption of the hob (Wh/kg)	182,7	182,7	182,7	182,7	191,5	194,2	191,5	194,2
Dimensions								
Product width (mm)	770	590	590	590	770	770	590	590
Product depth (mm)	520	520	520	520	520	520	520	520
Product height (mm)	50	50	50	50	170	250	170	275
Built-in height (mm)	755	565	565	565	750	750	560	565
Built-in depth (mm)	495	495	495	495	490	490	490	490
Ventilation slot (mm)	5	5	5	5	-	5	-	5
Fixing system	Quick-Fix System	Quick-Fix System	Quick-Fix System	Quick-Fix System	Easy fix	Quick-fix System	Easy fix	Quick-fix System
Minimum worktop thickness					-			
Finishing								
Colour	Black	Black	White	Sand	Black	Black	Black	Black
Aesthetic	Front bevel	Front bevel	Front bevel	Front bevel	Front bevel	Front bevel	Front bevel	Front bevel
Control								
Control type	Independent Slider for each area	Independent Slider for each area	Independent Slider for each area	Independent Slider for each area	Slider	Touch	Slider	Touch
Power selection (+/-)	Individual per zone	Individual per zone	Individual per zone	Individual per zone	Centralizado	Centralized	Centralizado	Centralized
Power levels	9 + Booster	9 + Booster	9 + Booster	9 + Booster	9 + Booster	9 + Booster	9 + Booster	9 + Booster
Connectivity	No	No	No	No	No	No	No	No
Cooking functions by temperature					No	No	No	No
Cooking functions	3	3	3	3	3	1	3	1
Cooking zone division by power					No	No	No	No
Pot displacement recognition					No	No	No	No
Pasta/rice timer function					No	No	No	No
Automatic start function					No	No	No	No
Pan speed function					No	No	No	No
Demo mode					Yes	No	Yes	No
AUTO cooking function					Yes	No	Yes	No
Memory function					Yes	No	Yes	No
Timer	Yes	Yes	Yes	Yes	Yes	Yes	Yes	Yes
Countdown alarm	Yes	Yes	Yes	Yes	Yes	Yes	Yes	Yes
Pause function					Yes	No	Yes	No
Power management	No	No	No	No	Yes	No	Yes	No
Security								
Safety lock	Yes	Yes	Yes	Yes	Yes	Yes	Yes	Yes
Residual heat indicator	Yes	Yes	Yes	Yes	Yes	Yes	Yes	Yes
Automatic pan detection	Yes	Yes	Yes	Yes	Yes	Yes	Yes	Yes
Automatic safety switch-off	Yes	Yes	Yes	Yes	Yes	Yes	Yes	Yes
Protection against liquid spillage	Yes	Yes	Yes	Yes	Yes	Yes	Yes	Yes
Electrical connection								
Nominal voltage (V)	220-240	220-240	220-240	220-240	220-240	220-240	220-240	220-240
Mains frequency (Hz)	50-60	50-60	50-60	50-60	50-60	50-60	50-60	50-60
Connection cable length								
Three-phase connection possible								
Max Product power (kW)	11	7,4	7,4	7,4	7,4	7,35	7,4	7,35

08024402	08081401	08063404	08053000	08063500	08063122	08063123	08063116	08073212	08040406
8422248109413	8422248109536	8422248109482	8.42225E+12	8422248108577	8422248355735	8422248357159	8422248351836	8422248112703	8422248079594
INSB 9012 BK	INSB 8021 BK	INSB 6032 BK	INSB 6030 WH	INSB 6028 BK	INSB 6003E2	INSB 6003E2 WH	IBS 6303E2	ISB 603 BK /A	INSB 6004 BK
Induction	Induction	Induction	Induction	Induction	Induction	Induction	Induction	Induction	
5	4	3	3	3	3	3	3	3	4
210x200	180	-	-	-	-	-	-	-	160
2	1,2	-	-	-	-	-	-	-	1,2
2,8	1,5	-	-	-	-	-	-	-	1,5
182,7	179,5	-	-	-	-	-	-	-	182,8
210x200	-	320/190	300/180	280/180	300	300	280	280	180
1,5	-	3/1,5	3	3	2,3	2,3	2,3	2,3	1,8
2	-	3,6/1,8	3,6	3,6	3	3	3	3	2,3
182,9	-	175,4	175,4	175,4	180,8	180,8	180,8	180,8	179,2
-	-	-	-	-	-	-	-	-	-
-	-	-	-	-	-	-	-	-	-
-	-	-	-	-	-	-	-	-	-
300	300	-	-	-	-	-	-	-	-
2,3	2,3	-	-	-	-	-	-	-	-
3	3	-	-	-	-	-	-	-	-
216,3	216,3	-	-	-	-	-	-	-	-
210x200	210x200	210	210	210	230	230	210	210	210
1,5	1,5	2,3	2,3	2,3	2,3	2,3	2,3	2,3	2,3
2	2	2,6	2,6	2,6	2,6	2,6	2,6	2,6	2,6
182,9	182,9	191,5	191,5	191,5	184,1	184,1	184,1	184,1	182,9
210x200	210x200	160	160	160	180	180	160	160	160
2	2	1,2	1,2	1,2	1,2	1,2	1,2	1,2	1,2
2,8	2,8	1,5	1,5	1,5	1,5	1,5	1,5	1,5	1,5
182,7	182,7	194,8	194,8	194,8	181,7	181,7	181,7	181,7	182,8
189,5	190,4	187,2	187,2	187,2	182,2	182,2	182,2	182,2	184
900	800	630	590	590	590	590	590	590	590
520	520	520	520	520	520	520	520	520	520
60	60	60	60	60	58	58	58	58	58
875	745	565	565	565	560	560	560	565	565
495	495	495	495	495	490	490	490	495	495
5	5	5	5	5	-	-	-	5	5
Quick-Fix System	Quick-Fix System	Quick-Fix System	Quick-Fix System	Quick-Fix System	Quick-Fix System	Quick-Fix System	Quick-Fix System	Quick-Fix System	Quick-Fix System
Black	Black	Black	White	Black	Black	White	Black	Negro	Negro
Front bevel	Front bevel	Front bevel	Front bevel	Front bevel	Front bevel	Front bevel	Rounded	Rounded	Front bevel
Independent Slider for each area	Independent Slider for each area	Independent Slider for each area	Independent Slider for each area	Independent Slider for each area	Independent Slider for each area	Independent Slider for each area	Independent Slider for each area	Slider	Independent Slider for each area
Individual per zone	Individual per zone	Individual per zone	Individual per zone	Individual per zone	Individual per zone	Individual per zone	Individual per zone	Centralized	Individual per zone
9 + Booster	9 + Booster	9 + Booster	9 + Booster	9 + Booster	9 + Booster	9 + Booster	9 + Booster	9 + Booster	9 + Booster
		AUTO	AUTO	AUTO 2					
3	3	3	3	3	3	3	3		
Yes	Yes	Yes	Yes	Yes	Yes	Yes	Yes	Yes	Yes
Yes	Yes	Yes	Yes	Yes	Yes	Yes	No	No	No
No	No	Yes	Yes	Yes	Yes	Yes	Yes	No	No
Yes	Yes	Yes	Yes	Yes	Yes	Yes	Yes	Yes	Yes
Yes	Yes	Yes	Yes	Yes	Yes	Yes	Yes	Yes	Yes
Yes	Yes	Yes	Yes	Yes	Yes	Yes	Yes	Yes	Yes
Yes	Yes	Yes	Yes	Yes	Yes	Yes	Yes	Yes	Yes
Yes	Yes	Yes	Yes	Yes	Yes	Yes	Yes	Yes	Yes
220-240	220-240	220-240	220-240	220-240	220-240	220-240	220-240	220-240	220-240
50-60	50-60	50-60	50-60	50-60	50-60	50-60	50-60	50-60	50-60
9	7,2	7,1	7,1	7,1	7,1	7,1	7,1	7,1	7,2

Code	08063120	08063121	08074007	08001206	08063119	08081202	08081100	08081210	08027206	08060010
EAN	8422248355919	8422248355926	8422248094191	8422248355278	8422248355704	8422248054478	8422248075473	8422248109529	8422248060189	8422248373166
Model	IB 6303E2 BK	IB 6403E2 BK	IB 5003 BK	IB 6304E2 BK	IB 6324E2 BK	IB 753 BK	IB 073 BK	IB 853 BK	IB 772 /A	IB 4002 BK
Type	Induction	Induction	Inducción	Inducción	Inducción	Induction	Induction	Induction	Induction	Induction
Product fiche										
Cooking zones	3	3	3	4	4	3	3	3	2	2
Right front zone: Diameter (mm)	-	-	-	160	160	-	-	-	-	-
Right front zone: Power (kW)	-	-	-	1,2	1,2	-	-	-	-	-
Right front zone: Booster (kW)	-	-	-	1,5	1,5	-	-	-	-	-
Right front zone: Consumption (Wh/kg)	-	-	-	183,4	183,4	-	-	-	-	-
Right rear zone: Diameter (mm)	280	250	280	180	180	270	270	270	210	280/180
Right rear zone: Power (kW)	2,3	1,8	2,3	1,8	1,8	2,3	2,3	2,3	2,3	3
Right rear zone: Booster (kW)	3	2,3	3	2,3	2,3	3	3	3	2,6	3,6
Right rear zone: Consumption (Wh/kg)	180,8	181,5	180,8	180,8	180,8	187,2	187,2	187,2	176,3	175,4
Central front zone: Diameter (mm)	-	-	-	-	-	-	-	-	-	-
Central front zone: Power (kW)	-	-	-	-	-	-	-	-	-	-
Central front zone: Booster (kW)	-	-	-	-	-	-	-	-	-	-
Central front zone: Consumption (Wh/kg)	-	-	-	-	-	-	-	-	-	-
Central rear zone: Diameter (mm)	-	-	-	-	-	180	180	180	-	-
Central rear zone: Power (kW)	-	-	-	-	-	1,4	1,4	1,4	-	-
Central rear zone: Booster (kW)	-	-	-	-	-	-	-	-	-	-
Central rear zone: Consumption (Wh/kg)	-	-	-	-	-	184,9	184,9	184,9	-	-
Front left zone: Diameter (mm)	210	180	180	180	210	220	220	220	-	160
Front left zone: Power (kW)	2,3	1,8	1,8	1,8	2	2,3	2,3	2,3	-	1,2
Front left zone: Booster (kW)	2,6	-	2,3	2,3	2,3	3	3	3	-	1,5
Front left zone: Consumption (Wh/kg)	184,1	183,4	184,9	180,8	182,9	176,3	176,3	176,3	-	181,7
Left rear zone: Diameter (mm)	160	160	160	160	160	-	-	-	280	182,5
Left rear zone: Power (kW)	1,2	1,5	1,2	1,2	1,2	-	-	-	2,3	-
Left rear zone: Booster (kW)	1,5	-	1,5	1,5	1,5	-	-	-	3	-
Left rear zone: Consumption (Wh/kg)	181,7	181,7	181,7	195,4	195,4	-	-	-	180,8	-
Energy consumption of the hob (Wh/kg)	182,2	182,2	182,5	185,3	185,3	182,8	182,8	182,8	178,6	180,6
Dimensions										
Product width (mm)	590	590	590	590	590	770	730	800	750	450
Product depth (mm)	520	520	520	520	520	390	430	400	450	520
Product height (mm)	58	58	58	58	58	68	68	68	68	65
Built-in height (mm)	560	560	565	560	560	750	710	750	710	420
Built-in depth (mm)	490	490	495	490	490	370	410	370	410	490
Ventilation slot (mm)	-	-	5	-	-	5	5	5	5	5
Fixing system	Quick-Fix System	Quick-Fix System	Quick-Fix System	Quick-Fix System	Quick-Fix System	Quick-Fix System	Quick-Fix System	Quick-Fix System	Quick-Fix System	Quick-Fix System
Minimum worktop thickness										
Finishing										
Colour	Black	Black	Black	Black	Black	Black	Black	Black	Black	Black
Aesthetic	Rounded	Rounded	Rounded	Rounded	Rounded	Rounded	Front bevel	Rounded	Front bevel	Front bevel
Control										
Control type	Touch	Touch	Touch	Touch	Touch	Touch	Slider	Touch	Slider	Slider
Power selection (+/-)	Centralized	Centralized	Centralized	Centralized	Centralized	Centralized	Centralized	Centralized	Centralized	Centralized
Power levels	9 + Booster	9 + Booster	9 + Booster	9 + Booster	9 + Booster	9 + Booster	9 + Booster	9 + Booster	9 + Booster	9 + Booster
Connectivity		AUTO 2			AUTO 2					AUTO 2
Cooking functions by temperature										
Cooking functions	3	3			3					3
Cooking zone division by power										
Pot displacement recognition										
Pasta/rice timer function										
Automatic start function										
Pan speed function										
Demo mode										
AUTO cooking function										
Memory function										
Timer	Yes	Yes	Yes	Yes	Yes	Yes	Yes	Yes	Yes	Yes
Countdown alarm	No	No	No	No	No	Yes	Yes	Yes	Yes	Yes
Pause function										
Power management	Yes	Yes	No	Yes	Yes	No	No	No	No	No
Security										
Safety lock	Yes	Yes	Yes	Yes	Yes	Yes	Yes	Yes	Yes	Yes
Residual heat indicator	Yes	Yes	Yes	Yes	Yes	Yes	Yes	Yes	Yes	Yes
Automatic pan detection	Yes	Yes	Yes	Yes	Yes	Yes	Yes	Yes	Yes	Yes
Automatic safety switch-off	Yes	Yes	Yes	Yes	Yes	Yes	Yes	Yes	Yes	Yes
Protection against liquid spillage	Yes	Yes	Yes	Yes	Yes	Yes	Yes	Yes	Yes	Yes
Electrical connection										
Nominal voltage (V)	220-240	220-240	220-240	220-240	220-240	220-240	220-240	220-240	220-240	220-240
Mains frequency (Hz)	50-60	50-60	50-60	50-60	50-60	50-60	50-60	50-60	50-60	50-60
Connection cable length										
Three-phase connection possible										
Max Product power (kW)	7,1	5,3	6,5	7	7	6,7	6,7	6,7	5,6	4,2

08027208	08003405	08063214	08063413	08063215	08040011	08072202	08063212	08063411	08077001	08060405	08049007
8422248109420	8422248109314	8422248373142	8422248357357	8422248373159	8422248109321	8422248109505	8422248109475	8422248109499	8422248109512	8422248109444	8422248109437
IB 2 PLUS BK	ISB 3102 BK	TTS 6032	TDM 6003	TT 6004	TN 604 /B	606 HVI /C	TT 6003	TD 6003 BK	TT 5003	TD 3002 BK /A	VI 302 /D
Induction	Induction	Radiant	Radiant	Vitroc�r�mica	Radiant	Radiant	Radiant	Radiant	Radiant	Radiant	Radiant
2	2	3	3	4	4	4	3	3	3	2	2
-	180	180	180	180	180	160	185	180	180	-	-
-	1,2	1,8	1,8	1,8	1,8	1,2	1,8	1,8	1,8	-	-
-	1,5	-	-	-	-	-	-	-	-	-	-
-	183,2	195,4	195,4	195,4	191,3	183,82	172,4	195,4	147,1	-	-
180	200	140	140	140	140	195	150	140	140	-	-
1,4	2	1,2	1,2	1,2	1,2	1,8	1,2	1,2	1,2	-	-
-	2,3	-	-	-	-	-	-	-	-	-	-
184,9	180,2	185,4	185,4	185,4	194,1	183,33	180,4	185,4	147	-	-
-	-	-	-	-	-	-	-	-	-	159	160
-	-	-	-	-	-	-	-	-	-	1,2	1,2
-	-	-	-	-	-	-	-	-	-	-	-
-	-	-	-	-	-	-	-	-	-	190,5	183,82
-	-	-	-	-	-	-	-	-	-	190/120	195
-	-	-	-	-	-	-	-	-	-	2,0/1,0	1,8
-	-	-	-	-	-	-	-	-	-	-	-
-	-	-	-	-	-	-	-	-	-	181,3	183,33
-	-	-	-	180	140	195	-	-	-	-	-
-	-	-	-	1,8	1,2	1,8	-	-	-	-	-
-	-	-	-	-	-	-	-	-	-	-	-
-	-	-	-	195,4	187,7	183,33	-	-	-	-	-
220	-	320/260/210	270/210	210/140	180	160	280/220/155	270/210	270/210/145	-	-
2,3	-	4/3/2	2,4/1,5	2,2/1,2	1,8	1,2	2,7/1,8/0,9	2,4/1,5	2,7/1,95/1,05	-	-
3	-	-	-	-	-	-	-	-	-	-	-
176,3	-	193,5	193,5	189,9	183,4	183,82	174	193,5	140,1	-	-
180,6	182,2	191,4	191,4	194	189,1	183,57	175,5	191,4	144,7	185,9	183,57
590	290	590	590	590	590	590	590	590	600	290	290
350	520	520	520	520	520	520	520	520	435	520	520
68	65	47	67	47	67	44	47	67	67	65	44
560	265	560	560	560	560	560	560	560	580	265	270
330	495	490	490	490	490	490	490	490	415	495	490
5	5	-	-	-	-	-	-	-	-	-	-
Quick-Fix System	Quick-Fix System	Quick-Fix System	Quick-Fix System	Quick-Fix System	Quick-Fix System	Quick-Fix System	Quick-Fix System	Quick-Fix System	Quick-Fix System	Quick-Fix System	Quick-Fix System
Black	Black	Black	Black	Preto	Black	Black	Black	Black	Black	Black	Black
Front bevel	Rounded	Front bevel	Rounded	Arredondado	Rounded	Rounded	Rounded	Rounded	Rounded	Rounded	Rounded
Slider	Slider	Slider	Independent Slider for each area	Slider	Touch	Mechanical	Touch	Touch	Touch	Touch	Mechanical
Centralized	Centralized	Centralized	Centralized	Centralizado	Centralized	Knobs	Centralized	Centralized	Centralized	Centralized	Knobs
9 + Booster	9 + Booster	9	9	9	9	9	9	9	9	9	9
Yes	Yes	Yes	Yes	Sim	Yes	No	Yes	Yes	Yes	Yes	No
Yes	Yes	Yes	Yes	Sim	Yes	No	Yes	Yes	Yes	Yes	No
No	No	No	No	N�o	No	No	No	No	No	No	No
Yes	Yes	Yes	Yes	Sim	Yes	No	Yes	Yes	Yes	Yes	No
Yes	Yes	Yes	Yes	Sim	Yes	Yes	Yes	Yes	Yes	Yes	Yes
Yes	Yes	No	No	N�o	No	No	No	No	No	No	No
Yes	Yes	Yes	Yes	Sim	Yes	No	Yes	Yes	Yes	Yes	No
Yes	Yes	Yes	Yes	Sim	Yes	No	Yes	Yes	Yes	Yes	No
220-240	220-240	220-240	220-240	220-240	220-240	220-240	220-240	220-240	220-240	220-240	220-240
50-60	50-60	50-60	50-60	50-60	50-60	50-60	50-60	50-60	50-60	50-60	50-60
3,5	3,5	7	5,4	6,5	6	6	5,7	5,4	5,7	3,2	3

Code	08005404	08046410	08041100	08041500	08041503	08041501	08041412
EAN	8422248081924	8422248081962	8422248072557	8422248072724	8422248078788	8422248073691	8422248058681
Model	LCI 9041 BK	L-7005 CI	LCI 6031 WH	LCI 6031 BK	LCIB 6031 BK	CCI 6031 BK	CI 631 BK A/A
Type (Glass /St.Steel /Enamelled)	Glass	Glass	Glass	Glass	Glass	Glass	Glass
Product fiche							
Suitable for City Gas	√	√	√	√	-	√	√
Suitable for LPG	-	-	-	-	√	-	-
Number of burners	5	5	4	4	4	4	4
Triple ring power [kW]	3,5	3,5	3,5	3,5	3,5	3,5	3,5
Fast power [kW]	3	3	3	3	3		
Semi-fast power [kW]	1,75	1,75	1,75	1,75	1,75	1,75	1,75
Semi-fast power [kW]	1,75	1,75				1,75	1,75
Auxilliar power [kW]	1	1	1	1	1	1	1
Triple ring consumption [l/h]	333	333	333	333	94	333	333
Fast consumption [l/h]	286	286	286	286	88		
Semi-fast 1 consumption [l/h]	167	167	167	167	69	167	167
Semi-fast 2 consumption [l/h]	167	167				167	167
Auxilliar consumption [l/h]	95	95	95	95	73	95	95
Dimensions							
Appliance width [mm]	874	700	640	640	640	590	590
Appliance depth [mm]	520	510	510	510	500	510	510
Appliance height [mm]	55	55	55	55	55	52	52
Built-in width [mm]	828	555	555	555	555	555	555
Built-in depth [mm]	478	470	475	475	475	475	475
Anchor system	Fixation brackets	Fixation brackets	Fixation brackets	Fixation brackets	Fixation brackets	Fixation brackets	Fixation brackets
Characteristics							
Plug-in autoignition	√	√	√	√	√	√	√
Enamelled Grills/Burners	-	-	-	-	-	-	√
Cast Iron Grills/Burners	√	√	√	√	√	√	-
Security							
Safety valve	√	√	√	√	√	√	√
Electrical Connection							
Nominal voltage (V)	220-240	220-240	220-240	220-240	220-240	220-240	220-240
Mains frequency (Hz)	50-60	50-60	50-60	50-60	50-60	50-60	50-60
Product power (kW)	11	11	9,25	9,25	9,25	8	8
Accessories							
LPG butane/natural kit conversor (included)	√	√	√	√	√	√	√

Code	08028403	08005350	08045305	08066002	08066011	08066600	08006301
EAN	8422248058674	8422248081948	8422248108812	8422248058735	8422248067331	8422248067775	8422248093767
Model	RCI 631 BK	LGI 9041 X	LGI 7041 X /A	LGD 631 X	GI 6031 X	GI 6004 X	LGI 6031 X
Type (Glass /St.Steel /Enamelled)	Glass	St.Steel	St.Steel	St.Steel	St.Steel	St.Steel	St.Steel
Product fiche							
Suitable for City Gas	√	√	√	-	√	√	√
Suitable for LPG	-	-	-	√	-	-	-
Number of burners	4	5	5	4	4	4	4
Triple ring power [kW]	3,5	3,5	3,5	3,5	3,5		3,5
Fast power [kW]		3	3	3		3	3
Semi-fast power [kW]	1,75	1,75	1,75	1,75	1,75	1,75	1,75
Semi-fast power [kW]	1,75	1,75	1,75		1,75	1,75	
Auxilliar power [kW]	1	1	1	1	1	1	1
Triple ring consumption [l/h]		333	333	333	333		333
Fast consumption [l/h]		286	286	286		286	286
Semi-fast 1 consumption [l/h]		167	167	167	167	167	167
Semi-fast 2 consumption [l/h]		167	167		167	167	
Auxilliar consumption [l/h]		95	95	95	95	95	95
Dimensions							
Appliance width [mm]	584	850	680	580	580	580	580
Appliance depth [mm]	510	500	500	510	500	500	500
Appliance height [mm]	55	55	45	45	45	45	52
Built-in width [mm]	452	828	555	552	555	555	555
Built-in depth [mm]	470	478	475	470	475	475	475
Anchor system	Fixation brackets	Fixation brackets	Fixation brackets	Fixation brackets	Fixation brackets	Fixation brackets	Fixation brackets
Characteristics							
Plug-in autoignition	√	√	√	√	√	√	√
Enamelled Grills/Burners	-	-	-	-	√	√	-
Cast Iron Grills/Burners	√	√	√	√	-	-	√
Security							
Safety valve	√	√	√	√	√	√	√
Electrical Connection							
Nominal voltage (V)	220-240	220-240	220-240	220-240	220-240	220-240	220-250
Mains frequency (Hz)	50-60	50-60	50-60	50-60	50-60	50-60	50-60
Product power (kW)	8	11	11	9,25	8	7,5	8
Accessories							
LPG butane/natural kit conversor (included)	√	√	√	√	√	√	√

08068400	08068401	08068403	08068405	08068501	08068309	08068402	08041505	08047410
8422248068352	8422248068376	8422248078795	8422248086929	8422248073707	8422248067355	8422248073677	8422248094269	8422248093743
CIB 6031 BK	LCI 6021 BK	LCIB 6021 BK	SCI 6021 BK	CCI 6021 BK	CI 6021 BK	CIB 6021 BK	CCI 5003 BK	SCI 3002 BK
Glass	Glass	Glass	Glass	Glass	Glass	Glass	Glass	Glass
-	√	-	√	√	√	-	√	√
√	-	√	-	-	-	√	-	-
4	3	3	3	3	3	3	3	2
3,5	3,5	3,5	3,5	3,5	3,5	3,5	3,5	
								3
1,75	1,75	1,75	1,75	1,75	1,75	1,75	1,75	
1,75								
1	1	1	1	1	1	1	1	1
94	333	94	333	333	333	94	333	
								286
69	167	69	167	167	167	69	167	
69								
73	95	73	95	95	95	73	95	95
590	590	580	580	590	590	590	590	300
510	510	500	500	510	510	510	450	520
52	55	55	55	52	52	52	55	55
555	555	555	555	555	555	555	555	280
475	475	475	475	475	475	475	400	480
Fixation brackets	Fixation brackets	Fixation brackets	Fixation brackets	Fixation brackets	Fixation brackets	Fixation brackets	Fixation brackets	Fixation brackets
√	√	√	√	√	√	√	√	√
√	-	-	-	-	√	√	-	-
-	√	√	√	√	-	-	√	√
√	√	√	√	√	√	√	√	√
220-240	220-240	220-240	220-240	220-240	220-240	220-240	220-240	220-240
50-60	50-60	50-60	50-60	50-60	50-60	50-60	50-60	50-60
8	6,25	6,25	6,25	6,25	6,25	6,25	6,25	4
√	√	√	√	√	√	√	√	√

08066607	08066312	08068308	08068310	08039600	08039601
8422248067775	8422248068369	8422248067348	8422248073684	8422248108829	8422248108829
LGI 6004 X	GIB 6004 X	GI 6021 X	GIB 6021 X	GI 3002 X /A	LGI 3002 X
St.Steel	St.Steel	St.Steel	St.Steel	St.Steel	St.Steel
√	-	√	-	√	√
-	√	-	√	-	-
4	4	3	3	2	2
		3,5	3,5		
3	3			3	3
1,75	1,75	1,75	1,75		
1,75	1,75				
1	1	1	1	1	1
		333	94		
286	286			286	286
167	167	167	69		
167	167				
95	95	95	73	95	95
580	580	580	580	300	300
500	500	500	500	520	520
45	45	45	45	45	45
555	555	555	555	280	280
475	475	475	475	480	480
Fixation brackets	Fixation brackets	Fixation brackets	Fixation brackets	Fixation brackets	Fixation brackets
√	√	√	√	√	√
-	√	√	√	√	-
√	-	-	-	-	√
√	√	√	√	√	√
220-240	220-240	220-240	220-240	220-240	220-240
50-60	50-60	50-60	50-60	50-60	50-60
7,5	7,5	6,25	6,25	4	4
√	√	√	√	√	√

Code	07200078	07200080	07200079	07820081
EAN	8422248351379	8422248351393	8422248351386	8422248351409
Model	LVI 62014	LVI 48010	LVI 62012	LVI 47010
Finish	Built-in	Built-in	Built-in	Built-in
Product fiche according to EU Regulation 2019/2022 - 2019/2017				
Rated capacity (ps)	14	10	14	10
Height (cm)	815	815	815	815
Width (cm)	598	448	598	448
Depth (cm)	550	550	550	550
Energy Efficiency Index (EEI)	49,9	49,9	55,9	55,9
Energy efficiency class (1)	D	D	E	E
Cleaning performance index (IC)	A	A	A	A
Drying performance index (ID)	A	A	A	A
Energy consumption in kWh (per cycle), based on the ECO programme (2)	0,849	0,674	0,951	0,755
Energy consumption in kWh (per 100 cycle), based on the ECO programme (2)	85	68	95	76
Water consumption in litres (per cycle), based on the ECO programme (3)	11	9	11	9
Duration of the eco programme (Tt) (h:min)	3:18	3:35	3:35	3:55
Type	Built-in	Built-in	Built-in	Built-in
Airborne acoustical noise emissions (dB(A))	47	47	47	47
Airborne acoustical noise emission class	C	C	C	C
Power consumption in off-mode (Po) (W)	0,49	0,49	0,49	0,49
Power consumption in standby mode (Psm) (W)	/	/	/	/
Delay start (W) (if applicable)	1	1	1	1
Networked standby (W) (if applicable)	No	No	No	No
Technical documentation (UE) 2019/2017				
Standard programme energy consumption (SPEC) (kWh/cycle)	1,7	1,35	1,7	1,35
Does standby mode include the display of information?	Yes	Yes	Yes	Yes
Power consumption in standby mode (Psm) in condition of networked standby (if applicable), (W)	/	/	/	/
Power consumption in delay start (Pds) (if applicable) (W)	1	1	1	1
Duration of the Left-on Mode (TI) (min) (EP)	/	/	/	/
Product dimensions				
Height min/max (mm)	815-865	815-865	815-865	815-865
Width [mm]	598	448	598	448
Depth [mm]	550	550	550	550
Adjustable legs	Yes	Yes	Yes	Yes
Cabinet and door dimensions				
Minimum cabinet height [mm]	820-870	820-870	820-870	820-870
Minimum cabinet width [mm]	600	450	600	450
Minimum cabinet depth [mm]	580	580	580	580
Max door height (built-in models) [mm]	720	720	720	720
Sliding door	No	No	No	No
Control panel				
Display / LED	Display	Display	Display	Display
Salt control pilot light	Yes	Yes	Yes	Yes
Rinse aid control pilot light	Yes	Yes	Yes	Yes
Time remaining indicator	Yes	Yes	Yes	Yes
Delay for starting operation	1-24	1-24	1-24	1-24
Programs and functions				
Number of programs	8	8	8	8
Intensive [°C-min]	65	65	65	65
Normal [°C-min] - Universal	55	55	55	55
Eco [°C-min]	50	45	45	45
Express 90' [°C-min]	55	55	60	55
Glass [°C-min]	50	50	50	50
Rapid 30' [°C-min]	40	40	45	50
Soak (min)	-	-	-	-
Automatic [°C-min]	55-65	55-65	55-65	55-65
Start / Pause function	Yes	Yes	Yes	Yes
Half load function	Yes	Yes	Yes	Yes
Extra drying function	Yes	Yes	Yes	Yes
Flex wash function (Alternative wash function)	-	-	-	-
Total Clean function (Strong wash function)	-	-	-	-
Equipment				
Upper basket with height regulation	Yes	Yes	Yes	Yes
Upper basket foldable support for cups	Yes	Yes	Yes	Yes
Upper/Lower basket foldable supports	Yes	Yes	Yes	Yes
Type of dispenser	Compact Sliding	Compact Sliding	Compact Sliding	Compact Sliding
Slide&Go tray	-	-	-	-
Third tray	Yes	Yes	-	-
Additional specifications				
Motor	Inverter	Inverter	Inverter	Inverter
Automatic door open	Yes	Yes	-	-
Enabled for all in one detergent	Yes	Yes	Yes	Yes
Type of cavity	S. steel	S. steel	S. steel	S. steel
Safety				
Child lock	Yes	Yes	Yes	Yes
Triple security system	Yes	Yes	Yes	Yes
Power and water connection				
Voltage range [V]	220-240	220-240	220-240	220-240
Frequency [Hz]	50	50	50	50
Rated power [W]	1760-2100	1760-2100	1760-2100	1760-2100
Rated current [A]	8-8,75	8-8,75	8-8,75	8-8,75
Type of plug	Schuko	Schuko	Schuko	Schuko
Power cord length [m]	1,5	1,5	1,5	1,5
Inlet water hose length [m]	1,5	1,5	1,5	1,5
Drain water hose length [m]	1,4	1,4	1,4	1,4

DISHWASHER (1) Classes range from A (most efficient) to G (least efficient) (2) Energy consumption based on the ECO program, using cold water. The actual energy consumption depends on the conditions of use of the appliance (3) Water consumption in liters per year based on the ECO program. The actual water consumption depends on the conditions of use of the appliance. This appliance is suitable for washing normally soiled dishes and is the most efficient in terms of combined energy and water consumption.

Code	07900005
EAN	8422248360302
Model	LI 08015
Finish	Built-in
Product fiche according to EU Regulation 2019/2023	
Model identifier	LI 08015
Rated capacity (kg)	8
Energy efficiency class (1)	A
Water consumption in litres [per cycle], based on the ECO programme (3)	48
Spin speed (rpm) - Rated capacity	1350
Spin-drying efficiency class (4)	B
Type	Built-in
Airborne acoustical noise emissions in the spinning phase (dBA)	72
Airborne acoustical noise emission class (spinning phase)	A
Product dimensions	
Height min/max [mm]	825/845
Width [mm]	595
Depth [mm]	545
Adjustable legs	Yes
Cabinet and door dimensions	
Minimum cabinet height [mm]	825
Minimum cabinet width [mm]	600
Minimum cabinet depth [mm]	580
General features	
Motor type	Silence Inverter
Hatch door diameter [cm]	31
Drum type	Stainless Steel
Foam reduction system	Accessible
Load self adjustment	Yes
Control	
Control type	LED Digital Display
Independent washing temperature selection	Yes
Independent spinning speed selection	Yes
Delay start [h]	Yes
Start / Pause key	Yes
Countdown display	Yes
Washing cycle display	Yes
Programmes	
N° of programmes	16
Cotton	Yes
Sintetic	Yes
Delicates	Yes
ECO	Yes
20°C	Yes
Wool	Yes
Quick [min]	Yes
Express 15	Yes
Mix	Yes
Sport clothes	Yes
Baby clothes	Yes
Customized	Yes
Jeans	Yes
Steam	Yes
Special functions	
Prewash	Yes
Extra rinse	Yes
Temperature selection	Yes
Spin speed selection	Yes
Safety	
Child-lock door	Yes
Ro*284;294	Yes
Power and water connection	
Voltage range [V]	220-240
Frequency [Hz]	50
Rated power [W]	1.950
Rated current [A]	10
Type of plug	Schuko
Power cord length [mm]	150
Inlet water hose length [mm]	100
Drain water hose length [mm]	160

WASHING MACHINES Normal washing program: ECO 40-60 (1) Classes range from A (most efficient) to G (least efficient). (2) Weighted annual consumption based on the ECO 40-60 program. (3) Weighted annual consumption based on the ECO 40-60 program. Actual water consumption depends on how the appliance is used. (4) On a scale from A (most efficient) to G (least efficient).

Code	07800078	07800080
EAN	8422248350945	8422248373746
Model	CI-54177 ST / D	CI-54177 NF / D
Finish	Built-in	Built-in
Product fiche according to EU Regulation 2019/2016		
Category	7	7
Energy efficiency class	E	E
Energy consumption [kWh/year] (1)	216	223
Refrigerator storage volume [l]	179	180
Freezer storage volume **** [l]	70	68
Star rating	4	4
Frost-free fridge	-	Yes
Frost-free freezer	-	Yes
Power cut safe [h]	10	6
Freezing capacity [kg/24h]	3,2	6
Climate class (2)	N,ST	SN/N/ST/T
Noise emissions [dBA]	39	35
Installation type	Built-in	Built-in
Dimensions		
Height [mm]	1777	1785
Width [mm]	540	540
Depth [mm]	540	545
Soft closed	-	-
Opening of the door	Right	Right
Reversible doors	Yes	Yes
Sliding door	-	Yes
Wheels	-	-
External / Recessed handle	-	-
Control		
Cooling type	Static	No Frost
Control	Electronic	Electronic
Display	-	Yes
Inverter motor	-	Yes
Electronic refrigerator temperature regulation	Yes	Yes
Electronic freezer temperature regulation	-	Yes
Super cooling / Super freezing function	Yes / Yes	Yes / Yes
Holiday function	-	-
Winter-Summer function	-	-
Door open alarm	-	-
Automatic defrosting refrigerator/freezer	-	- / freezer
Refrigerator equipment		
Number of door balconies	3	3
Number of glass shelves	3	4
Wine rack	-	-
Drawer for fruits and vegetables	Yes	Yes
Chiller for meat and fish	-	-
Metallic inner decoration	-	Yes
Number of egg tray - Egg capacity	1-6	-
Sliding tray	-	-
Freezer equipment		
Number of drawers / closed drawers	3	3/2
Ice trays / Ice cube quantity	1-12	-
Illumination		
Fridge - Freezer lighting	Yes - /	Yes - /
LED lighting	Yes - /	Yes - /
Illumination gradual intensity	-	-
Power and water connection		
Voltage range [V]	220-240	220-240
Frequency [Hz]	50	50
Rated power [W]	115	160
Rated current [A]	0,75	0,8
Type of plug	Schuko	Schuko
Power cord length [mm]	1600	2000

FRIDGE (1) The actual energy consumption depends on the conditions of use of the device and its location, according to the results obtained in the standard test of 24 hours defined in EN 62552 regulation. (2) Type of climates: SN: From +10°C to +34°C ambient temperature. N: From +16°C to +32°C ambient temperature. ST: From +16°C to +38°C ambient temperature. T: From +16°C to +43°C ambient temperature.

Code	07751006	07751007	07751008	07751009	07702004	07701404	07751010	07751011
EAN	8422248101790	8422248101806	8422248101837	8422248371575	8422248098915	8422248110785	8422248371582	8422248371599
Model	VI 15107 X	VI 30117 X	VI 54024 X	VI 59036 X	VI 59082 X /A	VI 59082 BK	VI 59103 FS BK	VI 59177 FS BK
Finish	Stainless Steel	Stainless Steel	Stainless Steel	Stainless Steel	Stainless Steel	Black Glass	Black Glass	Black Glass
Product fiche according to EU Regulation 1060/2010								
Category	Compressor wine cooler	Compressor wine cooler	Compressor wine cooler	Compressor wine cooler	Compressor wine cooler	Compressor wine cooler	Compressor wine cooler	Compressor wine cooler
Energy efficiency class	G	G	G	G	G	G	G	G
Energy consumption [kWh/year]	144	137	135	140	144	144	150	168
Refrigerator storage volume [l]	20	52	62	85	129	129	181	328
Climate class	SN/N/ST	SN/N/ST	SN/N/ST	SN/N/ST	SN/N/ST	SN/N/ST	SN/N/ST	SN/N/ST
Noise emissions [dBA]	41	41	40	39	41	41	38	40
Installation type	Built-in	Built-in	Built-in	Built-in	Built-in	Built-in	Free standing	Free standing
Technical specs and control type								
Refrigerator system	Compressor	Compressor	Compressor	Compressor	Compressor	Compressor	Compressor	Compressor
Display	Touch control display on frontal panel	Touch control display on frontal panel	Touch control display on frontal panel	Touch control display on frontal panel	Touch control display on frontal panel	Touch control display on frontal panel	Touch control display on frontal panel	Touch control display on frontal panel
Wine cooler lighting	Led	Led	Led	Led	Led	Led	Led	Led
Temperature zones	1	2	1	2	2	2	2	2
Temperature ranges (°C)	5-20	5-22 / 5-22	5-20	5-22 / 5-22	5-22 / 5-22	5-22 / 5-22	5-22 / 5-22	5-22 / 5-22
Electronic lock	-	-	-	-	-	-	-	-
Storage levels	7	5	3	3	6	6	6	14
No. of wooden trays/ material	-	-	-	3 / Beech	-	-	6 / Beech	14 / Beech
Capacity (bottles)	7	17	28	36	46	46	65	124
Opening of the door	Right	Right	Right	Right	Right	Right	Right	Right
Reversible doors	Yes	Yes	Yes	Yes	Yes	Yes	Yes	Yes
Adjustable feet	Yes	Yes	Yes	Yes	Yes	Yes	Yes	Yes
Automatic opening	-	-	-	-	-	-	-	-
Connectivity	-	-	-	-	-	-	-	-
UV filter	-	-	-	-	-	-	-	-
Carbon filter	-	-	-	-	-	-	Yes	Yes
Door open alarm	-	-	-	-	-	-	-	-
Automatic defrost	-	-	-	Yes	-	-	Yes	Yes
LED / LED GRADUAL illumination	-	-	-	-	-	-	-	-
Ventilation type (inner/front)	-	-	-	Back	-	-	Side	Front
Dimensions								
Height [mm]	870-887	825-870	455	595	825-870	825-870	1036	1770
Width [mm]	150	295	590	590	595	595	595	595
Depth [mm]	525	570	563	563	567	567	570	570
Cabinet dimensions								
Minimum cabinet height [mm]	872-889	827-872	450	600	827-872	827-872	-	-
Minimum cabinet width [mm]	155	300	560-568	600	600	600	-	-
Minimum cabinet depth [mm]	560	600	550-560	570	600	600	-	-
Power connection								
Voltage range [V]	220-240	220-240	220-240	220-240	220-240	220-240	220-240	220-240
Frequency [Hz]	50	50	50	50	50	50	50	50
Rated power [W]	60	225	65	65	200	200	200	200
Type of plug	Schuko	Schuko	Schuko	Schuko	Schuko	Schuko	Schuko	Schuko
Power cord length [mm]	1500	1500	1500	1500	1500	1500	1500	1500

SINKS

Code	02625035	02625006	02621006	02624006	02624016	02625007	02625008	02625014	02625009	02625010
EAN	8422248370929	8422248108652	8422248108645	8422248108669	8422248108638	8422248369565	8422248369572	8422248373043	8422248369589	8422248369596
Model	CB-2 40-40 R10	CB 50-40 R10	CB 45-40 R10	CB 40-40 P R10	CB 40-40 R10	CB 18 40 R15	CB-2 /B	CB 50-40 /A	CBP 50-40	CB 45-40 /A
Dimensions										
Cutout dimension (width x length) [mm]	820x400	500x400	450x400	400x400	400x400	180x400	770x440	500x400	500x400	450x400
Dimensions (width x length x depth) [mm]	860x440x240	540x440x200	490x440x200	440x440x250	440x440x200	220x440x150	790x460x200	545x445x180	545x445x200	495x445x180
General features										
Type of sink	Undermount	Undermount	Undermount	Undermount	Undermount	Undermount	Undermount	Undermount	Undermount	Undermount
Material	Stainless steel	Stainless steel	Stainless steel	Stainless steel	Stainless steel	Stainless steel	Stainless steel	Stainless steel	Stainless steel	Stainless steel
Steel thickness [mm]	304	304	304	304	304	304	304	304	304	304
Colour	Steel	Steel	Steel	Steel	Steel	Steel	Steel	Steel	Steel	Steel
Bowl and draining rack details										
Bowl quantity	2	1	1	1	1	1	2	1	1	1
Bowl form	Square with inverted pyramid surface	Square with inverted pyramid surface	Square with inverted pyramid surface	Square with inverted pyramid surface	Square with inverted pyramid surface	Square	Square	Square	Square	Square
Draining rack	-	-	-	-	-	-	-	-	-	-
Draining rack quantity	-	-	-	-	-	-	-	-	-	-
Draining rack form	-	-	-	-	-	-	-	-	-	-
Draining rack position	-	-	-	-	-	-	-	-	-	-
Tap hole	-	-	-	-	-	-	-	-	-	-
Waterfall curtain	-	-	-	-	-	-	-	-	-	-
Glasswasher	-	-	-	-	-	-	-	-	-	-
Accessories										
Drainpipe type	Square 3 1/2"	Square 3 1/2"	Square 3 1/2"	Square 3 1/2"	Square 3 1/2"	Square 3 1/2"	Round 3 1/2"	Round 3 1/2"	Round 3 1/2"	Round 3 1/2"
Drainpipe quantity	2	1	1	1	1	1	2	1	1	1
Overflow tube	Yes	Yes	Yes	Yes	Yes	Yes	Yes	Yes	Yes	Yes
Soap dispenser	-	-	-	-	-	-	-	-	-	-
Cutting board	-	-	-	-	-	-	-	-	-	-
Drainer	-	-	-	-	-	-	-	-	-	-

Code	02625011	02625012	02625013	02625037	02624008	02624009	02624010	02625002	02625015	02625016
EAN	8422248369602	8422248369619	8422248369671	8422248371117	8422248109024	8422248109031	8422248109048	8422248369688	8422248369695	8422248369701
Model	CBP 45-40	CB 40-40 /E	CBP 40-40 /B	CDC 75 40 SBK	CBS-140-40 D R10	CBS-2 40-40 R10	CBS-1 54-40 R10	CDL-1 REV /A	CDL-1 EI /A	CDL-1 ED /A
Dimensions										
Cutout dimension (width x length) [mm]	450x400	400x400	400x400	730x450	840x490	840x490	570x490	770x480	770x480	770x480
Dimensions (width x length x depth) [mm]	495x445x200	445x445x180	445x445x200	750x450x200	860x510x200	860x510x200	590x510x200	790x500x180	790x500x180	790x500x180
General features										
Type of sink	Undermount	Undermount	Undermount	Top mount	Top mount	Top mount	Top mount	Built-in countertop	Built-in countertop	Built-in countertop
Material	Stainless steel 304	Stainless steel 304	Stainless steel 304	Stainless steel 304	Stainless steel 304	Stainless steel 304	Stainless steel 304	Stainless steel 304	Stainless steel 304	Stainless steel 304
Steel thickness [mm]	0,8	0,8	0,8	3	1,2	1,2	1,2	0,8	0,8	0,8
Colour	Steel	Steel	Steel	Black Steel	Steel	Steel	Steel	Steel	Steel	Steel
Bowl and draining rack details										
Bowl quantity	1	1	1	1	1	2	1	1	1	1
Bowl form	Square	Square	Square	Square	Square	Square	Square	Square	Square	Square
Draining rack	-	-	-	-	Yes	-	-	Yes	Yes	Yes
Draining rack quantity	-	-	-	-	1	-	-	1	1	1
Draining rack form	-	-	-	-	Square	-	-	Square	Square	Square
Draining rack position	-	-	-	-	Right	-	-	Left	Left	Right
Tap hole	-	-	-	Yes	Yes	Yes	Yes	-	Yes	Yes
Waterfall curtain	-	-	-	Yes	-	-	-	-	-	-
Glasswasher	-	-	-	Yes	-	-	-	-	-	-
Accessories										
Drainpipe type	Round 3 1/2"	Round 3 1/2"	Round 3 1/2"	Round 3 1/2"	Round 3 1/2"	Round 3 1/2"	Round 3 1/2"	Round 3 1/2"	Round 3 1/2"	Round 3 1/2"
Drainpipe quantity	1	1	1	1	1	1	1	1	1	1
Overflow tube	Yes	Yes	Yes	Yes	Yes	Yes	Yes	Yes	Yes	Yes
Soap dispenser	-	-	-	Yes	-	-	-	-	-	-
Cutting board	-	-	-	Yes	-	-	-	-	-	-
Drainer	-	-	-	Yes	-	-	-	-	-	-

Code	02625017	02625018	02625019	02625021	02625022	02625023	02625024	02625026	02625027	02625038	02602100
EAN	8422248369718	8422248369725	8422248369732	8422248369763	8422248369770	8422248369787	8422248369800	8422248369824	8422248369831	8422248371131	8422248108997
Model	CDP-1 REV /A	CDP-1 EI /A	CDP-1 ED /A	CDS-1 REV /A	CDS-1 EI /A	CDS-1 ED /A	C-2 AG /C	CSS60-1 /A	CSS-1 /A	CS-1 /A	RS-1 /A
Dimensions											
Cutout dimension (width x length) [mm]	840x480	840x480	840x480	740x415	740x415	740x415	770x480	576x444	480x380	460x460	Ø465
Dimensions (width x length x depth) [mm]	860x500x180	860x500x180	860x500x180	760x435x150	760x435x150	760x435x150	790x500x200	636x504x230	500x400x150	480x480x165	485x485x160
General features											
Type of sink	Built-in countertop	Built-in countertop	Built-in countertop	Built-in countertop	Built-in countertop	Built-in countertop	Built-in countertop	Built-in countertop	Built-in countertop	Built-in countertop	Built-in countertop
Material	Stainless steel 304	Stainless steel 304	Stainless steel 304	Stainless steel 304	Stainless steel 304	Stainless steel 304	Stainless steel 304	Stainless steel 304	Stainless steel 304	Stainless steel 304	Stainless steel 304
Steel thickness [mm]	0,8	0,8	0,8	0,5	0,5	0,5	0,8	0,7	0,6	0,8	0,7
Colour	Steel	Steel	Steel	Steel	Steel	Steel	Steel	Steel	Steel	Steel	Steel
Bowl and draining rack details											
Bowl quantity	1	1	1	1	1	1	2	1	1	1	1
Bowl form	Square	Square	Square	Square	Square	Square	Square	Square	Square	Square	Round
Draining rack	Yes	Yes	Yes	Yes	Yes	Yes	-	-	-	-	-
Draining rack quantity	1	1	1	1	1	1	-	-	-	-	-
Draining rack form	Square	Square	Square	Square	Square	Square	-	-	-	-	-
Draining rack position	Left	Left	right	Left	Left	right	-	-	-	-	-
Tap hole	-	Yes	Yes	-	Yes	Yes	Yes	Yes	-	Yes	Yes
Waterfall curtain	-	-	-	-	-	-	-	-	-	-	-
Glasswasher	-	-	-	-	-	-	-	-	-	-	-
Accessories											
Drainpipe type	Round 3 1/2"	Round 3 1/2"	Round 3 1/2"	Round 3 1/2"	Round 3 1/2"	Round 3 1/2"	Round 3 1/2"	Round 3 1/2"	Round 3 1/2"	Round 3 1/2"	Round 3 1/2"
Drainpipe quantity	1	1	1	1	1	1	2	1	1	1	1
Overflow tube	Yes	Yes	Yes	Yes	Yes	Yes	Yes	Yes	Yes	Yes	Yes
Soap dispenser	-	-	-	-	-	-	-	-	-	-	-
Cutting board	-	-	-	-	-	-	-	-	-	-	-
Drainer	-	-	-	-	-	-	-	-	-	-	-

Code	02506401	02506301	02500404	02500602	02500302	02500402
EAN	8422248371896	8422248371902	8422248375740	8422248361989	8422248371919	8422248371926
Model	CPB/A	XPB/A	NPB	CAB	XSE/A	CSE/A
Dimensions						
Dimensions (diameter, length) of spout braided hose [", cm]	3/8, 40	3/8, 40	3/8, 40	3/8, 36	3/8, 40	3/8, 40
Product dimensions (height x width x depth) [mm]	530x264x50	508x252x52	465x248x50	255/70x250x98	332x260x54	348x286x49
Base diameter	50	52	50	57	54	49
General features						
Water tap type	Single-lever	Single-lever	Single-lever	Single-lever	Single-lever	Single-lever
Material	Brass	Acero iNoxidable 304	Acero iNoxidable 304	Brass	Acero iNoxidable 304	Brass
Material of handle	Cast	Acero iNoxidable 304	Acero iNoxidable 304	Cast	Acero iNoxidable 304	Cast
Material of spout braided hose	Stainless steel 304	Stainless steel 304	Stainless steel 304	Stainless steel 304	Stainless steel 304	Stainless steel 304
Finish style	Chrome	INox	INox	Chrome	INox	Chrome
Installation place	Sink, cooktop	Sink, cooktop	Sink, cooktop	Sink, cooktop	Sink, cooktop	Sink, cooktop
Spout and control details						
Spout type	Long	Long	Long	Long	Long	Long
Spout form	Semi-professional	Semi-professional	Semi-professional	L form	L form	L form
Removable spout	Yes	Yes	Yes	No	Yes	Yes
Rotatory spout	Yes / 360°	Yes / 360°	Yes / 360°	Yes / 360°	Yes / 360°	Yes / 360°
Airy spout	Yes	Yes	Yes	Yes	Yes	Yes
Antiscale areator	Yes	Yes	Yes	Yes	Yes	Yes
Shower function	Yes	Yes	Yes	No	Yes	Yes
Flow limiter 5 litre/minute	Yes	Yes	Yes	Yes	Yes	Yes
Cold start	Yes	Yes	Yes	Yes	Yes	Yes
Control type	Handle	Handle	Handle	Handle	Handle	Handle
Hinged spout	-	-	-	Yes	-	-
Accessories						
Cartridge type	Ceramic discs	Ceramic discs	Ceramic discs	Ceramic discs	Ceramic discs	Ceramic discs
Flexible M10x1x3/8" x 360mm INox certified instalation hose	Yes	Yes	Yes	Yes	Yes	Yes

Code	02500601	02500403	02503401	02503402	02502401	02501402
EAN	8422248355308	8422248371933	8422248371957	8422248373241	8422248371964	8422248371971
Model	BSE	CSA/C	CMA/H	CMA INoX	CBA/E	CBB/D
Dimensions						
Dimensions (diameter, length) of spout braided hose [", cm]	3/8, 36	3/8, 40	3/8, 40	3/8, 40	3/8, 40	3/8, 40
Product dimensions (height x width x depth) [mm]	294x275x90	315x266x54	336x198x50	371x240x50	296x206x48	140x250x50
Base diameter	51,5	54	50	50	48	50
General features						
Water tap type	Single-lever	Single-lever	Single-lever	Single-lever	Single-lever	Single-lever
Material	Brass	Brass	Brass	Stainless steel 304	Brass	Brass
Material of handle	Cast	Cast	Cast	Stainless steel 304	Cast	Cast
Material of spout braided hose	Stainless steel 304	Stainless steel 304	Stainless steel 304	Stainless steel 304	Stainless steel 304	Stainless steel 304
Finish style	Black	Chrome	Chrome	INox	Chrome	Chrome
Installation place	Sink, cooktop	Sink, cooktop	Sink, cooktop	Sink, cooktop	Sink, cooktop	Sink, cooktop
Spout and control details						
Spout type	Long	Long	Long	Long	Long	Short
Spout form	L form	L form	Curved	Curved	Curved	Line
Removable spout	Yes	No	No	No	No	No
Rotatory spout	Yes / 360°	Yes / 360°	Yes / 360°	Yes / 360°	Yes / 360°	Yes / 360°
Airy spout	Yes	Yes	Yes	Yes	Yes	Yes
Antiscale areator	Yes	Yes	Yes	Yes	Yes	Yes
Shower function	Yes	No	No	No	No	No
Flow limiter 5 litre/minute	Yes	Yes	Yes	Yes	Yes	Yes
Cold start	Yes	Yes	Yes	Yes	Yes	Yes
Control type	Handle	Handle	Handle	Handle	Handle	Handle
Hinged spout	-	-	-	-	-	-
Accessories						
Cartridge type	Ceramic discs	Ceramic discs	Ceramic discs	Ceramic discs	Ceramic discs	Ceramic discs
Flexible M10x1x3/8" x 360mm INox certified instalation hose	Yes	Yes	Yes	Yes	Yes	Yes

DISHWASHERS

		LOADINGS			LANGUAGE MANUAL																								
CODE	MODEL	40HC	40'	20'	ES	EN	FR	PT	DE	IT	NL	DA	FI	SV	EL	RU	PL	HU	ZH	NO	AR	UK	RO	LT	KO	HE	CZ	SK	SR
07200078	LVI 62014	162	-	-	ES	EN	FR	PT	DE	-	-	-	-	-	-	-	-	-	-	-	-	-	-	-	-	-	-	-	-
07200080	LVI 48010	248	-	-	ES	EN	FR	PT	DE	-	-	-	-	-	-	-	-	-	-	-	-	-	-	-	-	-	-	-	-
07200079	LVI 62012	162	-	-	ES	EN	FR	PT	DE	-	-	-	-	-	-	-	-	-	-	-	-	-	-	-	-	-	-	-	-
07200081	LVI 47010	248	-	-	ES	EN	FR	PT	DE	-	-	-	-	-	-	-	-	-	-	-	-	-	-	-	-	-	-	-	-

WASHING MACHINE

		LOADINGS			LANGUAGE MANUAL																								
CODE	MODEL	40HC	40'	20'	ES	EN	FR	PT	DE	IT	NL	DA	FI	SV	EL	RU	PL	HU	ZH	NO	AR	UK	RO	LT	KO	HE	CZ	SK	SR
07900005	LI 08015	171	114	54	-	-	-	-	-	-	-	-	-	-	-	-	-	-	-	-	-	-	-	-	-	-	-	-	-

COOLING

		LOADINGS			LANGUAGE MANUAL																								
CODE	MODEL	40HC	40'	20'	ES	EN	FR	PT	DE	IT	NL	DA	FI	SV	EL	RU	PL	HU	ZH	NO	AR	UK	RO	LT	KO	HE	CZ	SK	SR
07800078	CI-54177 ST /D	109	-	-	ES	EN	FR	PT	-	-	-	-	-	-	-	-	-	-	-	-	-	-	-	-	-	-	-	-	-
07800080	CI-54177 NF /D	105	-	-	ES	EN	FR	PT	-	-	-	-	-	-	-	-	-	-	-	-	-	-	-	-	-	-	-	-	-
07751006	VI 15107 X	704	600	288	ES	EN	FR	PT	DE	-	-	-	-	-	-	-	-	-	-	-	-	-	-	-	-	-	-	-	-
07751007	VI 30117 X	397	304	144	ES	EN	FR	PT	DE	-	-	-	-	-	-	-	-	-	-	-	-	-	-	-	-	-	-	-	-
07751008	VI 54024 X	269	216	108	ES	EN	FR	PT	DE	-	-	-	-	-	-	-	-	-	-	-	-	-	-	-	-	-	-	-	-
07751009	VI 59036 X	216	-	-	ES	EN	FR	PT	DE	-	-	-	-	-	-	-	-	-	-	-	-	-	-	-	-	-	-	-	-
07702004	VI 59082 X /A	171	114	54	ES	EN	FR	PT	DE	-	-	-	-	-	-	-	-	-	-	-	-	-	-	-	-	-	-	-	-
07701404	VI 59082 BK	170	114	54	ES	EN	FR	PT	DE	-	-	-	-	-	-	-	-	-	-	-	-	-	-	-	-	-	-	-	-
07751010	VI 59103 FS BK	114	-	-	ES	EN	FR	PT	DE	-	-	-	-	-	-	-	-	-	-	-	-	-	-	-	-	-	-	-	-
07751011	VI 59177 FS BK	57	-	-	ES	EN	FR	PT	DE	-	-	-	-	-	-	-	-	-	-	-	-	-	-	-	-	-	-	-	-

SINKS

		LOADINGS		
CODE	MODEL	40HC	40'	20'
02625035	CB-2 40-40 R10	568	-	-
02625006	CB 50-40 R10	384	-	-
02621006	CB 45-40 R10	384	-	-
02624006	CB 40-40 P R10	384	-	-
02624016	CB 40-40 R10	384	-	-
02625007	CB 18 40 R15	-	-	-
02625008	CB-2 /B	-	-	-
02625014	CB 50-40 /A	-	-	-
02625009	CBP 50-40	-	-	-
02625010	CB 45-40 /A	-	-	-
02625011	CBP 45-40	-	-	-

SINKS

		LOADINGS		
CODE	MODEL	40HC	40'	20'
02625012	CB 40-40 /E	-	-	-
02625013	CBP 40-40 /B	-	-	-
02602500	CRB 45 40 BK	-	-	-
02602501	CRB 55 40 BK	-	-	-
02625037	CDC 75 40 SBK	-	-	-
02624008	CBS-140-40 D R10	494	419	194
02624009	CBS-2 40-40 R10	494	419	194
02624010	CBS-1 54-40 R10	696	590	274
02625002	CDL-1 REV /A	-	-	-
02625015	CDL-1 EI /A	-	-	-
02625016	CDL-1 ED /A	-	-	-

SINKS

		LOADINGS		
CODE	MODEL	40HC	40'	20'
02625017	CDP-1 REV /A	-	-	-
02625018	CDP-1 EI /A	-	-	-
02625019	CDP-1 ED /A	-	-	-
02625021	CDS-1 REV /A	-	-	-
02625022	CDS-1 EI /A	-	-	-
02625023	CDS-1 ED /A	-	-	-
02625024	C-2 AG /C	-	-	-
02625026	CSS60-1 /A	-	-	-
02625027	CSS-1 /A	-	-	-
02625038	CS-1 /A	-	-	-
02602100	RS-1 /A	720	-	-

TAPS

		LOADINGS		
CODE	MODEL	40HC	40'	20'
02506401	CPB/A	4050	-	-
02506301	XPB/A	4050	-	-
02500404	NPB	-	-	-
02500602	CAB	-	-	-
02500302	XSE/B	4610	-	-
02500402	CSE/A	4610	-	-

TAPS

		LOADINGS		
CODE	MODEL	40HC	40'	20'
02500601	BSE	1000	-	-
02500403	CSA/D	8144	-	-
02503401	CMA/H	7808	-	-
02503402	CMA INOX	7808	-	-
02502401	CBA/E	12176	-	-
02501402	CBB/D	18352	-	-











CATA ELECTRODOMÉSTICOS S.L.U.

Tlf: +34 938 594 100.- Fax +34 938 594 101.

www.cata.com - www.cnagroup.es - cna@cnagroup.es

Headquarters: c/ Anabel Segura, 11, Edif. A, 3a pl. 28108. Alcobendas (Madrid. Spain)

Factory: c/ del Ter, 2, Apdo. 9. 08570. Torelló (Barcelona. Spain)

CNA
group

cata

edesa

NODOR

Apelson